

The Wireless Constructor

6^D
MONTHLY

EDITED BY
PERCY W. HARRIS

CONTENTS

Vol. 1. No. 6. APRIL, 1925

HOW TO MAKE:

A POWERFUL THREE-VALVE SET.

By Percy W. Harris.

A SINGLE-VALVE RECEIVER FOR
VERY SHORT WAVELENGTHS.

By C. P. Allinson.

A TWO-VALVE AMPLIFIER FOR
YOUR CRYSTAL SET.

By D. J. S. Hartt, B.Sc.

A HIGHLY EFFICIENT CHOKE
AMPLIFIER.

By John W. Barber.

A TUNER FOR THE "SHORT-
WIRE" VALVE PANEL.

By A. S. Clark.

A LOOSE-COUPLED CRYSTAL SET.

By H. Bramford.

REACTION: ITS USE AND ABUSE.

By G. P. Kendall, B.Sc.

REMARKABLE NEW WIRELESS SYS-
TEM (EXCLUSIVE).

HOW TO FIT A GRID-BIAS BATTERY
TO YOUR SET.

HUNDREDS OF PRACTICAL
HINTS AND TIPS FOR THE
BEGINNER.

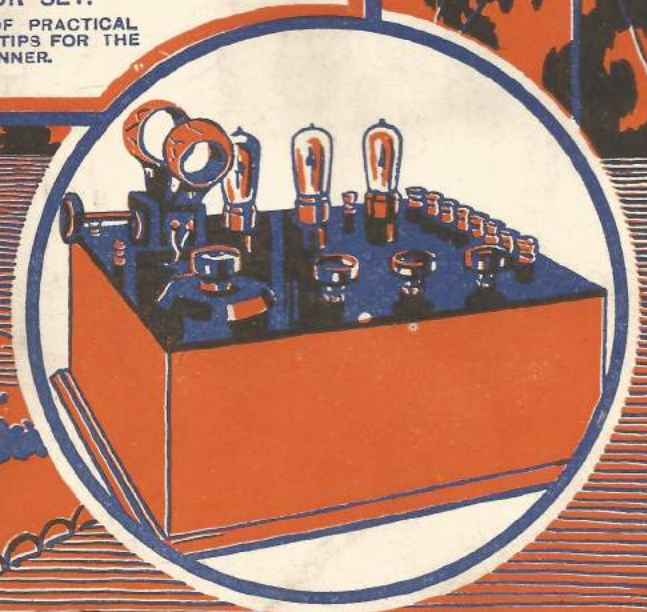

1/6 BLUEPRINT FREE INSIDE

THE WIRELESS CONSTRUCTOR "POWERFUL 3-VALVE" RECEIVER.

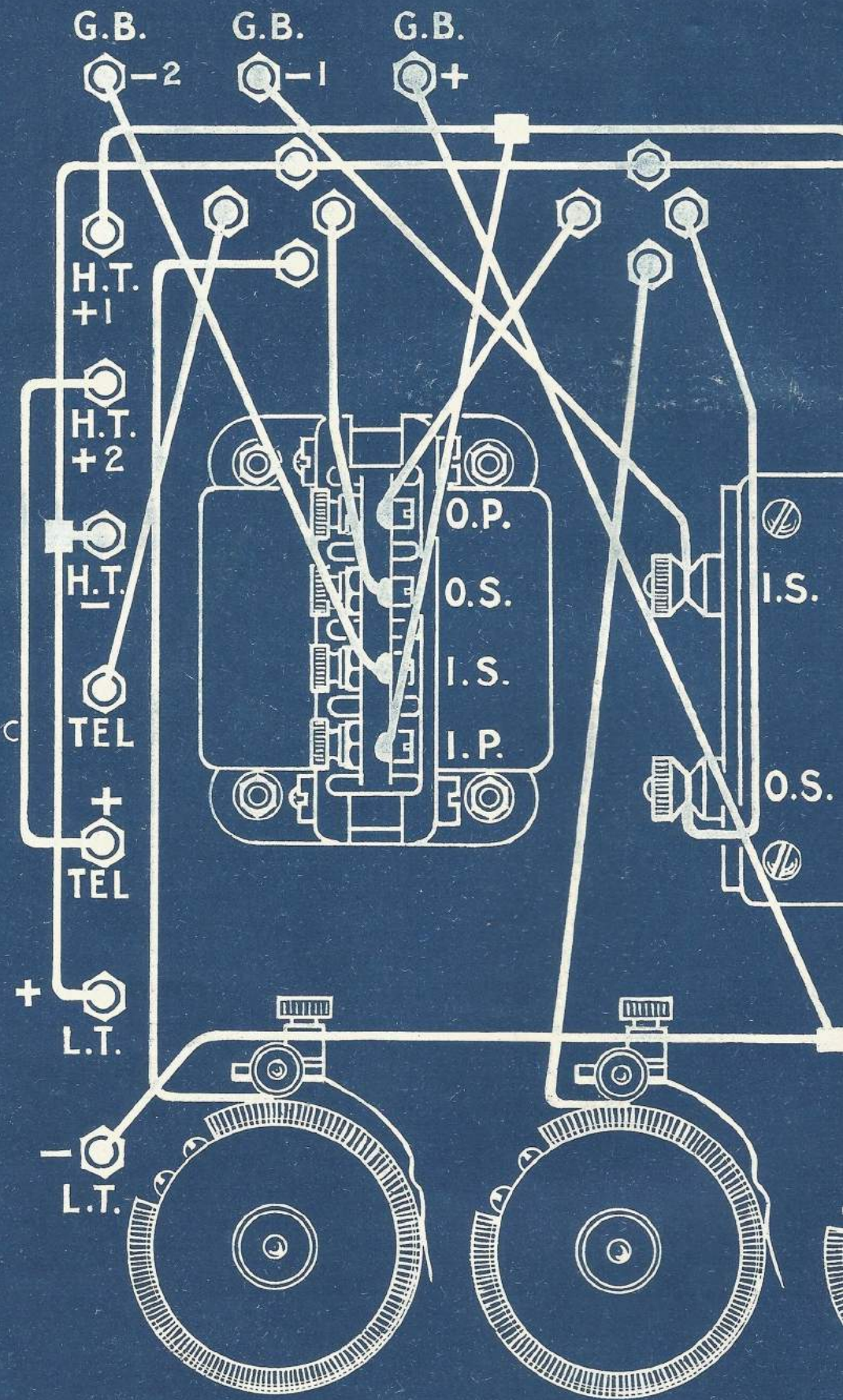

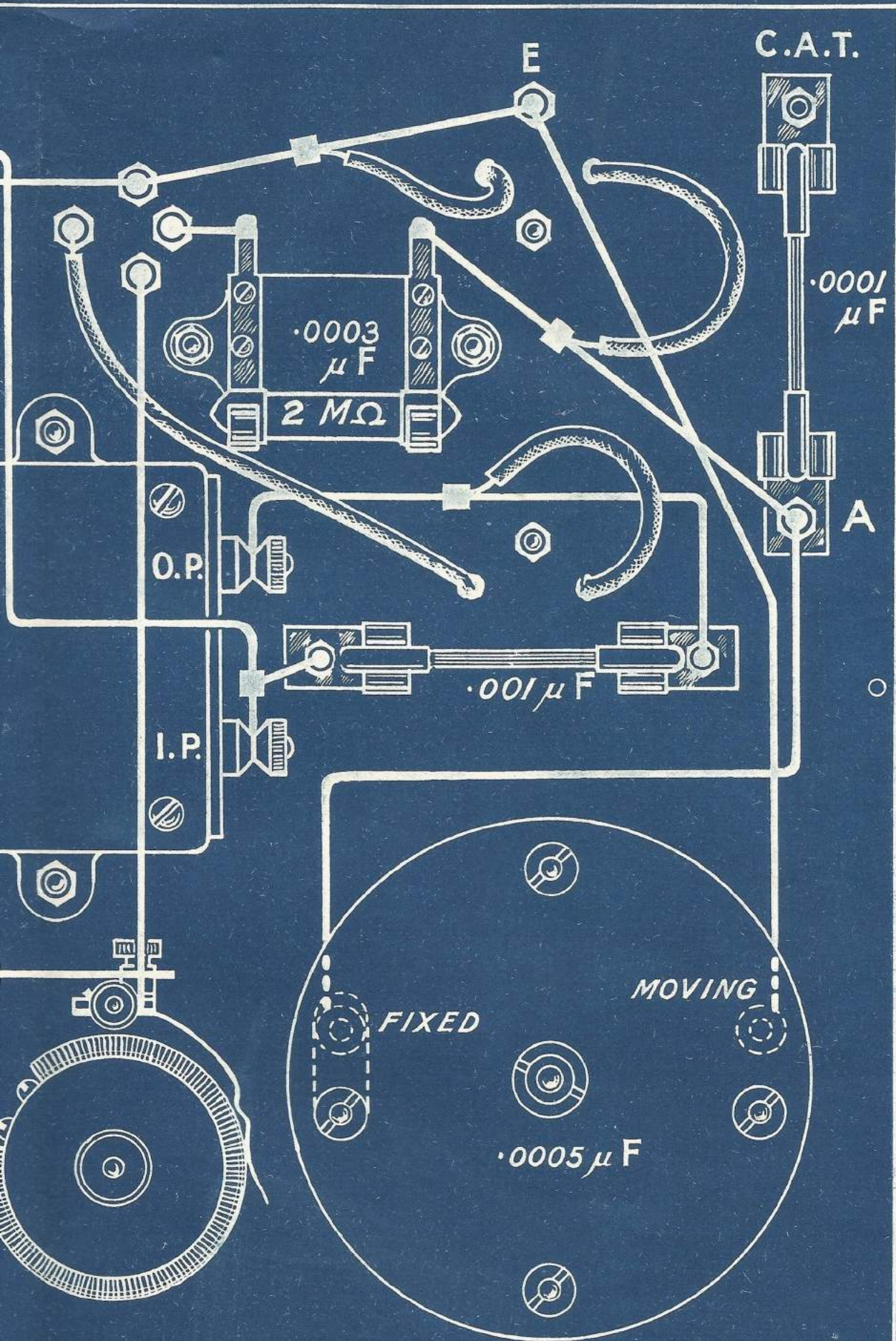

RADIO PRESS LTD., BUSH HOUSE, STRAND, W.C.2. Blue Print C.1011B Price 1/6.

Comprehensive Range



Single Ring Bright Filament Type Valve

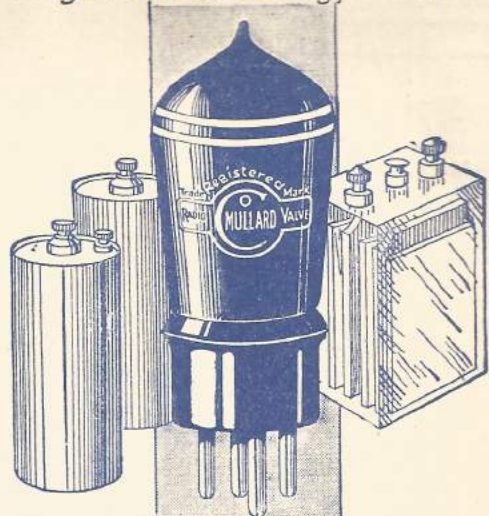

Double Ring Dull Filament Type Valve

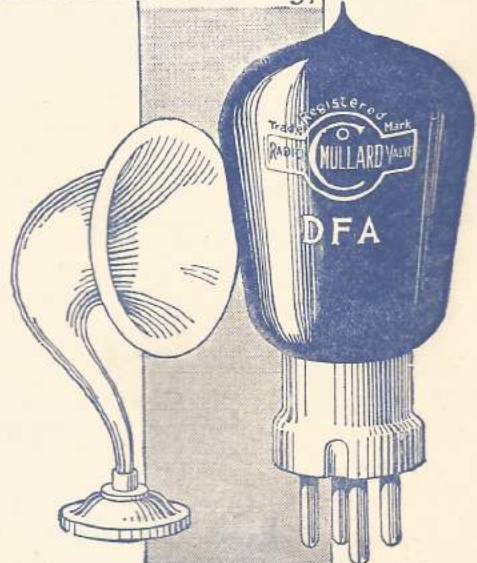

Loud Speaker Power Type Valve

Here are Master Valves for perfect long-distance and pure tone reception.

You will find in these three groups a range of Master Valves that will produce the finest wireless reception from your set. Each type of Mullard Valve is the best that modern research can produce. Make your own choice.

BRIGHT FILAMENT VALVES

FOR 4-VOLT ACCUMULATORS.

Mullard H.F. Red Ring Valves for H.F. AMPLIFICATION and DETECTION - - - - - 11/- each

Mullard L.F. Green Ring Valves for L.F. AMPLIFICATION - - - - - 11/- each

(Recommended for reflex or dual circuits.)
Leaflet M. 8 gives full information.

DULL FILAMENT VALVES

MULLARD H.F. DOUBLE RED RING VALVES FOR H.F. AMPLIFICATION.

Type D.3, for Accumulators - - - - - 18/- each

Type D.06, for Dry Cells - - - - - 21/- each

MULLARD L.F. DOUBLE GREEN RING VALVES FOR L.F. AMPLIFICATION.

Type D.3, for Accumulators - - - - - 18/- each

Type D.06, for Dry Cells - - - - - 21/- each

Leaflet V.R. 20 gives full information.

LOUD SPEAKER VALVES

Mullard D.F.A. 0, for 4-volt Accumulators - - - - - 26/- each

Mullard D.F.A. 1, for 6-volt Accumulators - - - - - 30/- each

Leaflet V.A. 4 gives full information.

All these Valves bear the Hall Mark of

Mullard

THE MASTER VALVE

The WIRELESS CONSTRUCTOR

— Edited by Percy W. Harris —

VOL. I. No. 6.APRIL

CONTENTS

<p>Full Power from Three Valves .. 495 By PERCY W. HARRIS, Editor.</p> <p>“What Happened to Jones” .. 499</p> <p>A Remarkable New Wireless System .. 501</p> <p>A Unit Choke Amplifier .. 503 By JOHN W. BARBER.</p> <p>A Pictorial Guide to Tuning .. 506</p> <p>Broadcasting and Drama .. 508 By “CARRIER-WAVE.”</p> <p>A Receiver for the Short-Wave Experimenter .. 513 By C. P. ALLINSON.</p> <p>Mr. Gumplethorpe Gets On .. 520 By “BROADCASTER.”</p>	<p>Take Care of your Telephones .. 524 By STANLEY G. RATTEE, M.I.R.E.</p> <p>Reaction—Its Use and Abuse .. 528 By C. P. KENDALL, B.Sc.</p> <p>The “Short-Wire” Tuner .. 532 By A. S. CLARK.</p> <p>A Chat on Amplifier Circuits .. 535</p> <p>An Amplifier for the “Stay-Set” Crystal Receiver .. 542 By D. J. S. HARTT, B.Sc.</p> <p>How it Works—the Condenser .. 547 By R. W. HALLOWS, M.A.</p> <p>Aerials for Awkward Places .. 554</p> <p>Workshop Hints .. 561</p> <p>A Loose-Coupled Crystal Receiver .. 570</p> <p>The Use of Grid-Bias .. 576</p>
---------------------------------------------------------------------------------------------------------------------------------------------------------------------------------------------------------------------------------------------------------------------------------------------------------------------------------------------------------------------------------------------------------------------------------------------------------------------------------	--------------------------------------------------------------------------------------------------------------------------------------------------------------------------------------------------------------------------------------------------------------------------------------------------------------------------------------------------------------------------------------------------------------------------------------------------------------------------------------------------------------------------------------------------------------------------------

GLAZITE

THE NEW COLOURED CONNECTING WIRE

No need to use Insulating Sleeving

Glazite connecting wire takes its place. Made of tinned copper wire, it is insulated with a special glazed covering. Glazite possesses exceptional insulating properties and is damp and flame proof. Glazite will not deteriorate in use.

Ask your radio dealer for Glazite. It is made up in neat coils 10 ft. in length and four different colours—RED, BLUE, YELLOW and BLACK. Price 1/6 per coil.

Send a postcard for Glazite Leaflet and name of nearest radio dealer carrying stock

THE LONDON ELECTRIC WIRE CO. & SMITHS, LTD.
Makers of Electric Wire for over forty years. Our mark is a guarantee of quality
Playhouse Yard, Golden Lane, London, E.C.1
Telegrams: Electric, London. Telephones: Clerkenwell 1383, 1389, 1390, 1391

*The Reasons for
this Important
Reduction!!*

The famous
**STERLING
LIGHTWEIGHT
HEADPHONES**
now offered at
22/6

Sterling Headphones at 25/- were always acknowledged as the best value in the world at that price. Improved manufacturing facilities and consistently increasing sales enable us to offer now these headphones at 22/6. Any test or comparison of this type of headphone will definitely show that it is of infinitely better value both in efficiency and design than the ordinary type now generally offered at 20/-.

The distinctive advantages of Sterling Headphones are:—

1. Better reproduction.
2. Longer life.
3. A superior finished article altogether, made from only the highest grade material throughout.
4. A precision instrument of scientific design and manufacture instead of the risk of what might be little better than a toy.

What better value could there possibly be for

22/6

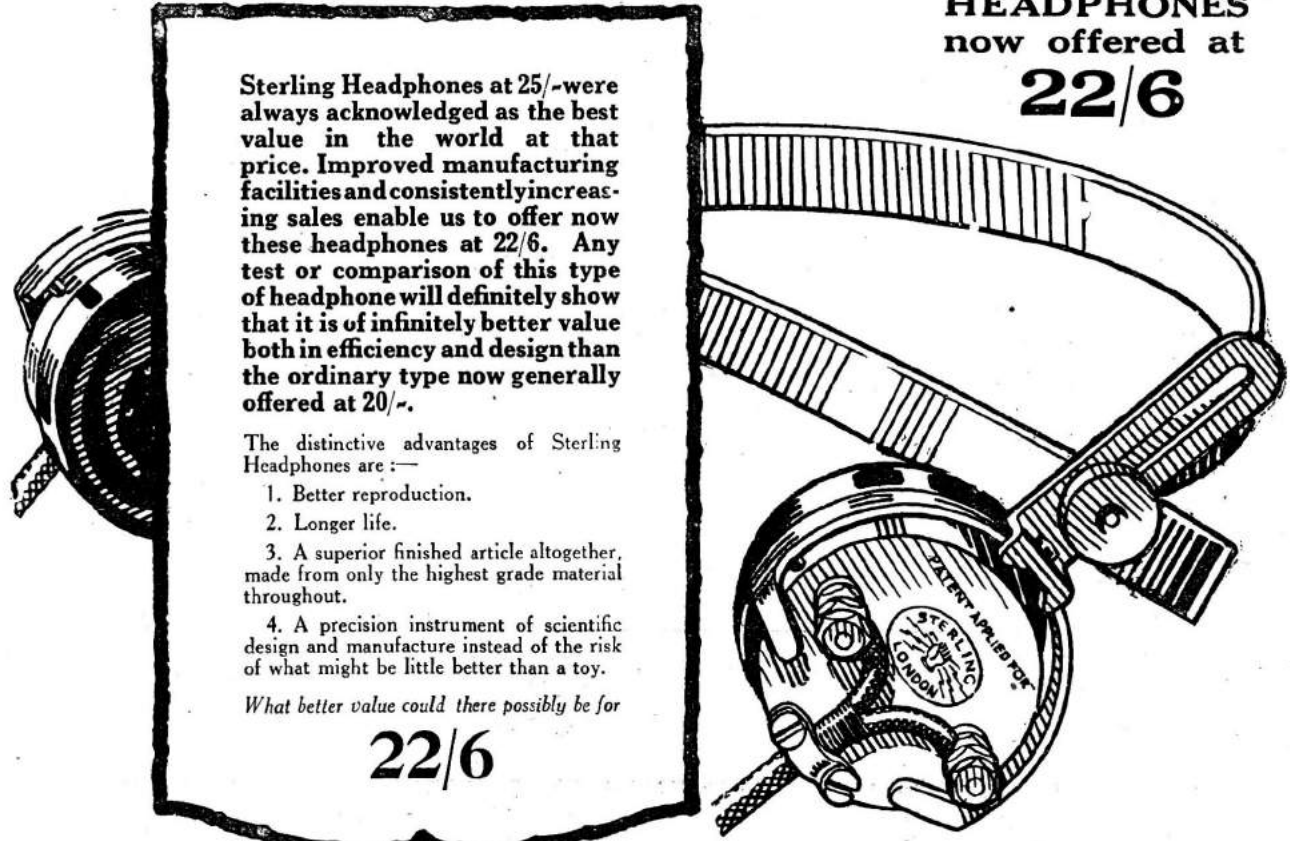

STERLING LIGHTWEIGHT HEADPHONES

At all Radio Dealers

Advt. of **STERLING TELEPHONE & ELECTRIC CO., LTD.**

Manufacturers of Telephones and Radio Apparatus, etc.

Telephone House, 210-212, Tottenham Court Rd., London, W.1 Works: Dagenham, Essex.



The WIRELESS CONSTRUCTOR

Scientific Adviser:
 Prof. G. W. O. HOWE,
 D.Sc., M.I.E.E.
Advisory Editors:
 Prof. R. WHIDDINGTON,
 M.A., D.Sc.
 Prof. C. L. FORTESCUE,
 M.A., M.I.E.E.

Staff Editors:
 E. H. CHAPMAN, M.A.
 D.Sc.
 A. D. COWPER, M.Sc.
 R. W. HALLOWS, M.A.
 G. P. KENDALL, B.Sc.
 S. G. RATTIE,
 Member I.R.E.

Vol. 1.

APRIL, 1925.

No. 6.

Full Power from Three Valves

By PERCY W. HARRIS, M.I.R.E., Editor

This simply made receiver is designed to give full volume from three valves, together with great simplicity in handling. Suitable component parts can be purchased from any radio dealer

A VALVE detector, followed by two stages of note magnification, is an excellent combination of valves for many purposes. If the note-magnifying valves are transformer coupled, and if good transformers are used, we shall get a high degree of magnification from each stage, and thus shall use our valves economically. For this reason the combination referred to is deservedly popular.

In the powerful three-valve set about to be described the circuit used is not new—in fact, it can be called quite old, so far as wireless counts. In putting the circuit into practical shape for this issue, I have found it possible to introduce one



Simplicity and ease of control are important features of this receiver.

or two novelties in design which help to make the set more pleasing in appearance than many built with the same circuit. Needless refinements have been eliminated, but provision is made for separate grid-bias for each note-magnifying valve, and for additional high-tension on the last stage, so that, if the reader desires, he can use a power valve in the correct manner. What you, personally, can receive with this set depends largely upon your aerial, your local conditions and your skill in handling. Even if you have never handled a set before, you will be able on an average outdoor aerial, after half an hour's practice, to tune in your local station on the loud-speaker, provided it is not more than 40 or 50 miles away.



If you are used to handling valve detectors using reaction, you will be able to hear (in the telephones) several, if not all, of the other broadcasting stations, with perhaps two or three of them on the loud-speaker. Personally, I have received America on this set by listening on a good night, but this must not be taken to indicate that I recommend

panel a two-coil holder by which the coupling between the reaction and the aerial coils can be varied. At the back of the instrument are placed three valve sockets, whilst along the front can be seen the knobs of the three filament resistances which control the brightness of the valve filaments. Suitable terminals are disposed on the right and left, with facility for

The filament resistances adopted are the type that have interchangeable bobbins, so that if at any time you should wish to change from bright to dull emitters, or *vice versa*, it is only necessary to unscrew a knob on each holder, withdraw the interchangeable bobbin, and replace it by one suitable for the new valves to be used. In this way we can change from bright emitters to the .06 type of dull emitter without any alterations of wiring.

Components

The components needed to make this set are very easily obtained. Whilst any good makes will do throughout, the makers of the actual parts used are named, so that any readers who wish to duplicate the set in every detail may do so.

One 12 by 10 by $\frac{1}{4}$ in. panel. This must be of a first-class insulating substance, free from surface leakage. There are many makes of guaranteed ebonite quite suitable for the purpose, and 12 by 10 in. panels, ready cut, are sold by large numbers of dealers. I have actually used a panel, not of ebonite, but made from a substance called Trolite.

One suitable box at least 5 in. deep.

Thirteen terminals.

One variable condenser, square law, .0005 microfarad. I have used the Peto-Scott, and can also recommend from personal experience square law condensers made by Sterling, Bowyer-Lowe and Jackson Bros. There are other makes of square law condensers I have not tried which might prove suitable here.

One first-stage intervalve transformer.

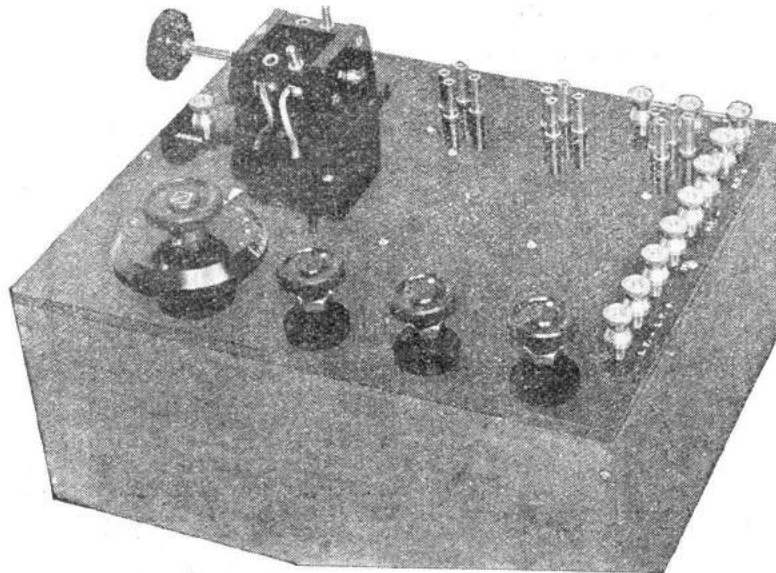

With coils and valves removed, this photograph gives a clear idea of the layout.

the set for regular long-distance reception. It is really designed for the man who wants to obtain the nearest station at good loud-speaker volume with the greatest simplicity in handling.

The Lay-out

In designing such a set we have the choice of several styles. We may adopt what is generally termed the "American" method, placing most of the components on a baseboard behind and the controlling knobs on a vertical panel, the valves being enclosed within the cabinet. This style has the advantage of a pleasing appearance, but is more difficult for the beginner to wire up. Secondly, we have the "English" method of mounting the various components on a single panel with valves outside. With good design, a pleasing appearance may still be obtained and, in addition, the wiring is much clearer to illustrate, and much simpler for the beginner. For this reason the latter style has been chosen for the present instrument.

If you examine the photographs you will see on the left of the

using the now popular "constant aerial tuning" as well as the more conventional parallel tuning.

Behind the panel you will see the variable condenser, grid-leak and condenser, two intervalve transformers, the constant-aerial-tuning condenser (interchangeable, between clips), and an interchangeable condenser across the primary of the first intervalve transformer.

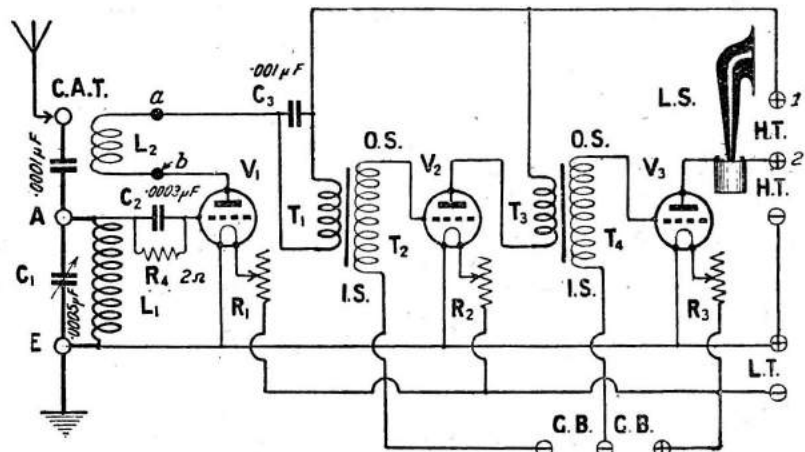

The theoretical circuit diagram.

One second-stage intervalve transformer. Many good makes will do here. I have used for the first stage a Cambrell, and the second a second-stage Igranic. This combination works well, and there is no tendency whatever to howl—a valuable feature.

Three filament resistances (I have used Polar bobbin interchangeable resistances). If you use these, purchase them with bobbins to suit the valves you are to use. It will only be necessary to specify whether they are for bright emitters or for a particular type of dull emitter, and the makers will supply the correct bobbin.

One grid condenser and leak, .0003 microfarads and 2 megohms (Dubilier). There are several other suitable makes.

One clip-in condenser with clips, .0001 microfarad (McMichael MH pattern).

One clip-in condenser with clips, .001 microfarad (McMichael MH pattern).

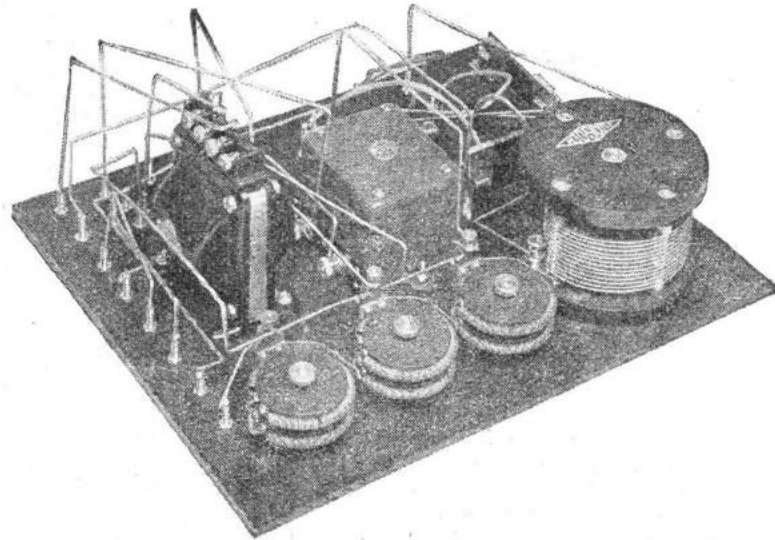

This view shows how the transformers and rheostats are mounted.

One two-coil holder. The particular pattern shown is Peto-Scott manufacture.

Three sets of valve sockets. No. 16 square wire for wiring up. A few B.A. countersunk head

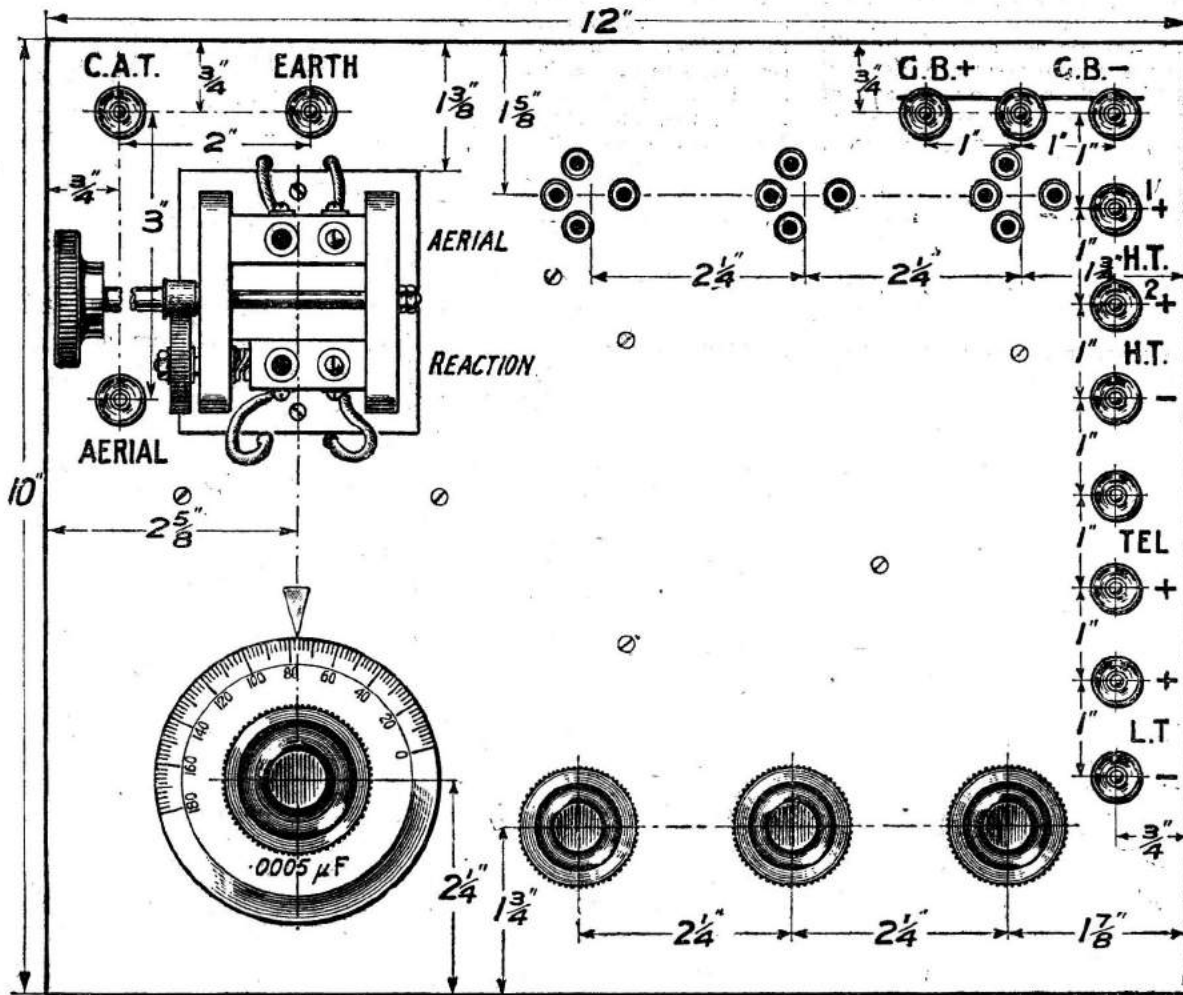

Drilling diagram of the panel, showing terminal markings. Blueprint No. C1011A.

metal screws with nuts for holding component parts to panel.

One set of Radio Press panel transfers.

Constructional Work

Having obtained your panel, collect together your other components and lay them out on the panel, remembering always that in this lay-out you are working from the *back* of panel, and therefore the order of parts will be reversed in relation to the front view. If you use the actual components indicated in the present set, you will, of course, be able to lay them out very accurately from the free blue print, but if you have used different makes it may be necessary to adjust the position of a few parts so as to work them into the space. In doing this, be careful to adhere as closely as possible to the original design, for the actual disposition of wiring is of great importance in any set.

Terminal positions and such-like can, of course, be marked out directly from the blue print. In any case, do not attempt to drill the panel until you have obtained *all* the parts, so as to make sure of their relative positions. Drilling should be carried out with care, and in the case of such components as terminals, these should be kept on a straight line to avoid an untidy appearance in the finished receiver. Notice that in addition to the holes for the securing of screws of the two-coil holder, four additional holes are drilled in the panel to allow flexible leads to pass through. These flexible leads are connected to the screws of the coil sockets by passing the wires underneath washers and screwing up tightly. The other ends are soldered to suitable points on the fixed wires, as shown.

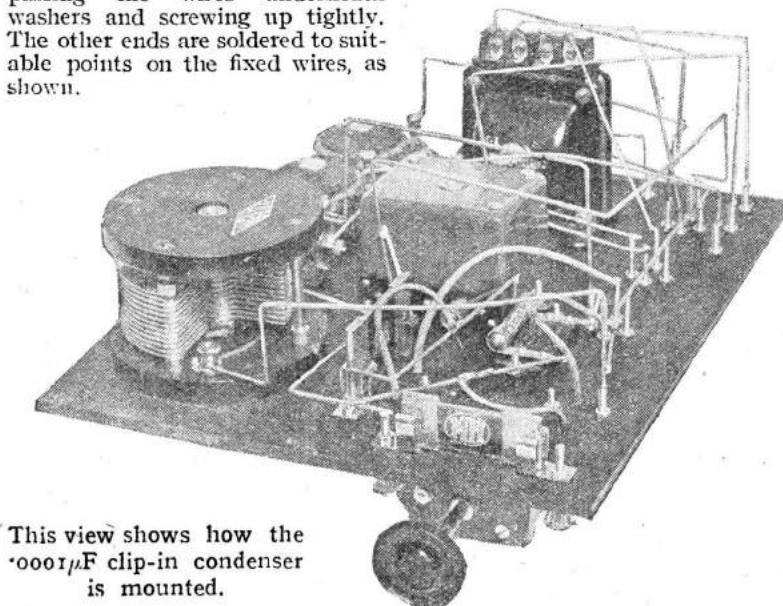

This view shows how the $.0001\mu\text{F}$ clip-in condenser is mounted.

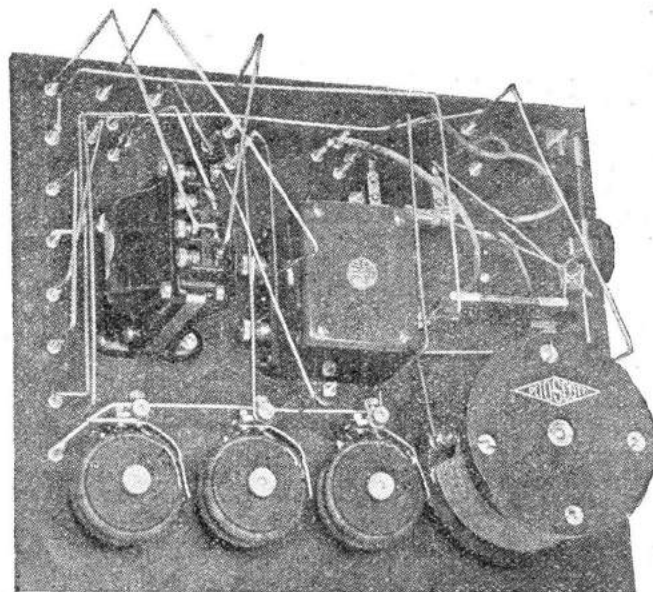

Note the short L.T. negative busbar to the rheostats.

Points in Wiring

Special points to note in wiring up are that the moving plates of the variable condenser should be connected to the earth terminal to avoid hand capacity effects. Notice, too, that the clips of the McMichael condenser are held beneath the lock nuts of the terminals "C.A.T." and "A" respectively. On some aerials you may find it advantageous to change the value of $.0001$ to, say, $.0002\mu\text{F}$, but in general $.0001$ will be found quite suitable. The O.S. terminal of each transformer should go to the grid of its respective valve, and the I.S. to the negative terminal of the grid-bias. The I.P.

and O.P. connections do not matter so much, but if you use the transformers indicated in the photograph, I advise you to adhere to the connections given. In other transformers it may be advantageous to reverse the I.P. and O.P. connections on one, or both, of the transformers. In any case, if, when the set is completed, it is found to howl (this may happen with some cheap transformers), reversing the I.P. and O.P. connections of one or both of the transformers should be tried to see whether this effects a cure. In most cases it will.

Notice, too, that a wire comes from the negative L.T. terminal to all three of the filament resistances, the other connections of which are taken to the filament legs of the valves.

Testing Out

When the set is wired up, carefully set the filament resistances to the "off" position and connect up the accumulator. Be careful that your connections are on the right terminals. For the moment do not connect any other wires, and then, having placed three valves in the sockets, turn on each filament resistance a little, to see whether the valves light. If they do, and proper control of filament brightness is obtained by rotating the knobs, leave the low-tension accumulator connected and connect up the high-tension battery, the aerial, the earth and the telephones or loud speaker. A loud speaker, if used, should be 2,000

(Continued on p. 552.)

WHAT HAPPENED TO JONES



HAVING STOOD THIS FOR TEN MILES - JONES WHO IS A CHAP WITH NO HOBBIES - DECIDES TO CHANGE CARRIAGES AT THE NEXT STOP

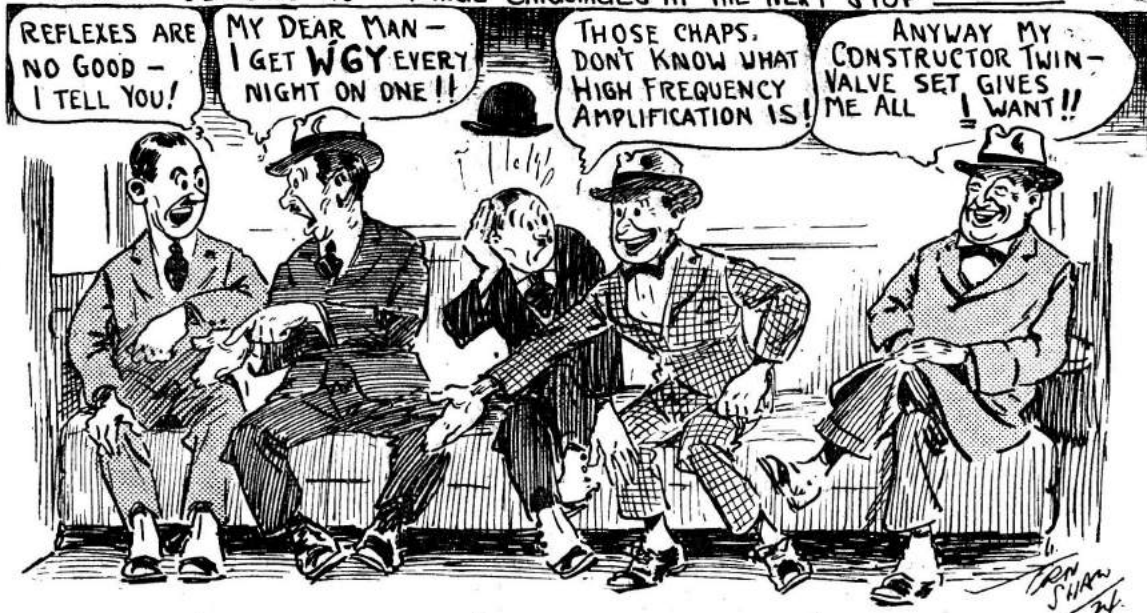

ONLY TO DISCOVER THAT HE HAS JUMPED OUT OF THE FRYING-PAN - INTO THE FIRE!

Golfers once had the monopoly in our local trains; now the Wireless Men are strong competitors!

Remarkable New Wireless System

EXCLUSIVE FIRST DESCRIPTION
For "THE WIRELESS CONSTRUCTOR"

This article describes a highly interesting system by which it is possible to don a pair of headphones which have no cords attached to them and to walk about the room while listening, unimpeded by dragging cords. The apparatus has been personally tested by the Editor, and certainly gives remarkable results

LISTENING to broadcasting by means of telephone receivers or a loud-speaker seems in these days such a simple matter that one is tempted to take "listening-in" for granted much in the same way as we make a journey by train or do any other of the hundred and one things which seem part of everyday existence. In general the main question is usually one of initial expense, that is, whether we are to be limited to the simple crystal set with "headphones"—possibly an extra pair or two to avoid the accusation of ultra-selfishness—or a valve and loud speaker outfit with which the family and one's friends can be enjoyably entertained—enjoyably, that is, if the receiver and loud-speaker are capable of giving faithful reproduction of the music, etc., transmitted by the broadcasting station.

A New Way

In certain circumstances, however, the provision of facilities for "listening-in" raises a problem greater than, and often far removed from, the question of cost. For example, the manager of the Royal Hotel, Somecity, is fully cognisant of the delights of broadcasting but is also mindful of the dissension and annoyance which it might occasion, some guests wanting nothing better than to listen to LO₂, others wanting "anything on earth but to listen to such stuff," or wishing to read without having LO₂'s entertainment superimposed upon the excitements of wondering what the next murder will be like or the prospect of the hero succumbing, in the next chapter, to the wiles of green-eyed Anthea. Still more difficult would be the atmosphere created at the club—especially if Brown and Jones, or Smith and Robinson, or any others of the old

school happened to be about seeking food for argument; in such circumstances the lot of the valiant member who suggested the importation of a loud-speaker outfit would be anything but pleasant. To think of overcoming the difficulty by installing a receiver to which several sets of "headphones" are connected is to overlook the inconvenience aspect of the question—the objection to sitting tethered to an instrument or to a point in some particular part of a room. What is required then to overcome such objections? Of the two known reproduction methods, neither the loud-speaker nor the telephones connected to the receiver meet our

ordinary way, or a single telephone receiver with a handle fitment will suffice if the headphones cannot be used conveniently—the case of Marcel waves v. radio waves, of course!

An Explanation

How is it done—what is the Hale-Lyle system? Primarily, it is a method of radio reception by causing the telephones to be operated by and in accordance with variation in the magnitude of an electrostatic field which is created in the rooms or places where reception is desired.

To do this, receiving apparatus is employed embodying an amplifier capable of so strengthening and converting the received signal energy as to apply high potentials to distributing grids or networks located in areas where reception is to be provided for. The electrostatic field will induce charges of considerable magnitude in any insulated conductive bodies within the field, and the potential difference between any two such bodies will be capable of creating telephonic currents if they are electrically connected through the coils of a telephone receiver. The encased headband of the telephones and the surface of the body of the person using them would comprise two bodies

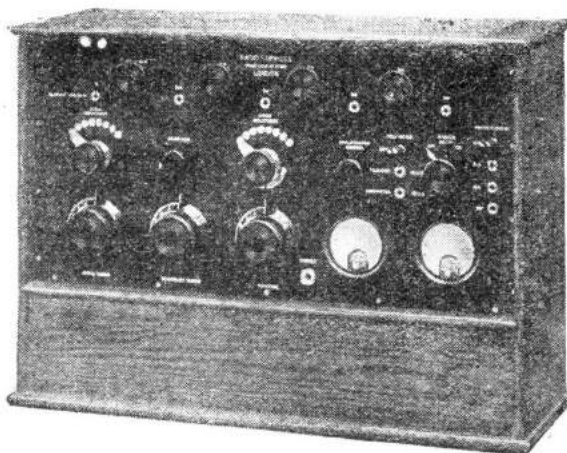

The commercial form of the Hale-Lyle receiver.

of different capacity to earth. We need to be able to listen, in whatever part of a room we may elect to sit, without being tethered and without occasioning annoyance to others who may be present, or we may desire some of our guests to be able to hear the broadcasting without requiring silence on the part of others who find greater pleasure in conversation.

The Hale-Lyle system provides the easy way out of our difficulties—we can listen by means of telephone receivers worn in the

of different capacity to earth. A metallic earcap joined to one end of the telephone coils serves to make connection to the body of the user, and all the coils are connected in series between the headbands on the one hand and the body of the wearer, through the metallic earcap, on the other hand. Within one earpiece is a condenser connected in a shunt path to the telephone windings between the conducting bodies, which offers small impedance to currents of high audio-frequency, but offers

a high impedance to currents of lower frequencies, so that the currents of the higher audio-frequencies have a relatively easy passage through the condenser, and their effect upon the telephone instrument is considerably reduced, whilst the lower frequency currents are obliged to pass through the windings. In this way, a more uniform response over a large range of frequencies is obtained, and any tendency to distortion, due to the comparatively low impedance of the resultant capacity of the conductive bodies to induced potentials of the higher audio-frequencies is eliminated. In the amplifier shown in the diagram, provision is also made for varying the degree of amplification in order that the same type of amplifier may be used under various conditions and give consistently satisfactory results. The degree of amplification required, for instance, if the receiving apparatus is to be used at a considerable distance from a broadcasting station would be higher than in the case of reception at a comparatively short distance. In order that the necessary variation may be obtained without affecting the working characteristics of the valves, and thereby causing distortion, a special form of amplification control has been developed.



The headphones are quite conventional in appearance. One ear-piece is covered with a special metal cap.

This consists of a pair of choke coils, which are connected in series



Sir James Allen, High Commissioner for New Zealand, with his headphones in the library. Notice the convenience of the cordless phones.

and through which the anode current of one of the valves of the amplifier is passed. The point of connection of the two coils is joined to the grid of the following valve through the usual grid condenser. Instead of the ordinary fixed iron core, a movable core is used, which can be made to occupy the central space within either of the coils or any intermediate position. A large difference of audio-frequency potential will be set up across whichever of the coils encloses the iron core, whilst the other coil will virtually short-circuit the audio-frequency potentials. By the adjustment of the position of the core relative to the coils the necessary gradual adjustment of the degree of amplification can be obtained.

The Output

The secondary winding of the high-tension output transformer of the amplifier has taps taken out to studs of a rotary switch for varying the ratio of the turns of the primary and secondary windings the points at which the distributing grids are connected to the secondary winding depending upon the area of the grids in use. The latter consist of fine-gauge wire in the form of a

network between rubber or stout paper sheets cemented together or fastened to the flooring or under-felt and placed beneath the carpets in areas to be served. They may also be accommodated in other ways according to the particular circumstances, as, for example, in trains where they may be conveniently placed beneath the seats.

For my lady's vanity-bag, a special telephone receiver in the form of a fan has been produced, the fan taking the place of the headband as the conductive body. This kind of "radio fan" makes reception of broadcasting delightfully easy and convenient.

An Interesting Demonstration

In the course of the Radio Engineering Company's experiments, the apparatus was installed at the residence of Mr. C. H. C. McIlwraith, Gidleigh Park, Devonshire, which is situated in a valley and screened by heavily wooded hills between which the Teign speeds its way—"truly a place of wondrous charm," but, from a radio standpoint, so "blind" that a four-valve set of a well-known

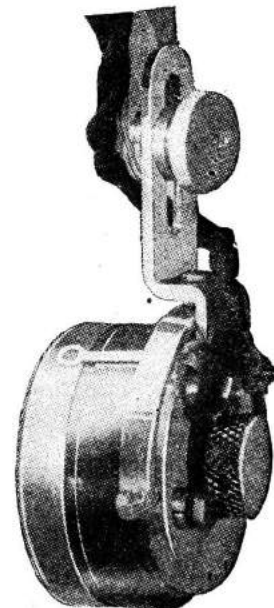

A "close-up" of the headphone cap which is an integral part of the system.

make could only induce a loud-speaker to whisper faintly. That the Cardiff and Bournemouth pro- telephones operated by variations in the magnitude of an electrostatic field was sufficiently convincing,

Albans, the effectiveness of the induced charges was well indicated by the operation of a loud-speaker standing on a copper plate to which one terminal was joined, the other terminal being connected to a log rack standing on the stone hearth, which served as the other conductive body. The signal strength was equal to that obtained when the loud-speaker was directly connected to a four-valve receiver. A growing plant was also used with equally striking results, and even the collective capacity of a nail in the wall, a drawer handle, or other small metal object has been found to be sufficient for the operation of the system.

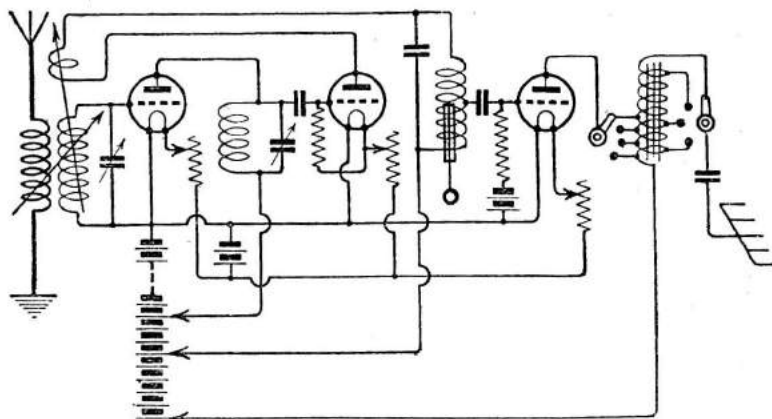

A circuit diagram, showing how the grids on the floor are connected to the output side of the instrument.

This method of remote reception has proved to be a most interesting field for experiment—as well as a source of no little mystification—and promises to widen considerably the scope of the broadcasting services.

grammes were well received under such conditions by means of and, during tests carried out at Mr. McIlwraith's house at St.

**A YOUNG
CONSTRUCTOR'S
RESULTS**

SIR,—I follow with great interest both THE WIRELESS CONSTRUCTOR and *Modern Wireless*, both of them excellent papers, and I have constructed many of the sets described, including the "Transatlantic Four" and the "Anglo-American Six," the results of which I give in this letter. I wrote not long ago giving my results with the "Transatlantic Four," but since then I have had excellent results, receiving WGY, WBZ, KDKA (long wave), and WTAM, on any occasion that I have tried, WGY at good loud-speaker strength.

The "Anglo-American Six," which I completed about a fortnight ago, gives good results on the wavelengths from about 370 upwards, as I have no lower wavelength H.F. transformers, and my present ones are not neutrodyne units, consisting of two matched Bowyer-Lowe (300-600) and one McMichael (300-600). I have received WGY with wonderful clarity of tone and very good signal strength on four valves.

I came to the conclusion that this receiver would work much

better if reaction were used, and this I tried, with greatly improved results. Of course, I did not allow my set to oscillate during broadcast hours, but the selectivity of the receiver was greatly improved.

I am 16 years of age, and have had nearly three years' radio experience, beginning with a crystal and working up to large valve sets.

I think your three journals are the best published, and I am very interested in the articles appearing

in *Wireless Weekly*, "Making a Start in Transmission."

Wishing you the best of luck with THE WIRELESS CONSTRUCTOR.

I remain, Yours truly,
KENNETH A. CHIPPINDALE.

[The introduction of separate reaction is unnecessary if correct adjustment of the neutrodyne condensers is carried out. The neutrodyne "verniers" introduce any reaction required.—ED., W.C.]



Mother teaches the children to listen-in!

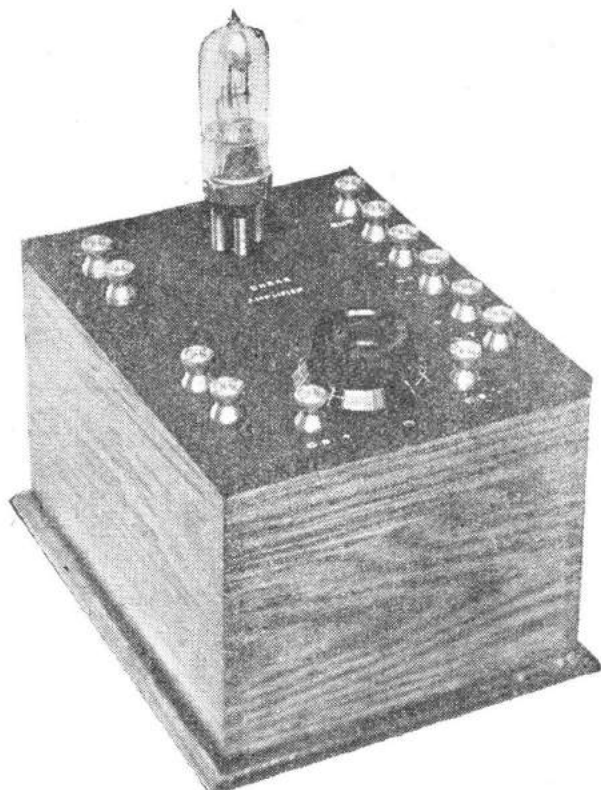

The filament rheostat is the only control.

A Unit Choke Amplifier

By JOHN W. BARBER

A useful amplifying unit made up on a little used principle. Simplicity and great purity are the essential features of this unit, which may be duplicated

rents in the secondary winding, and the voltage variations produced are applied to the grid of the low-frequency amplifying valve. In a resistance amplifier the varying potentials across the resistance in the anode circuit of the detector valve are applied to the grid of the low-frequency amplifier through a "stopping" condenser, a grid-leak being employed which is connected to the negative of the filament-heating battery, or to the negative of a grid-biasing battery.

WHEN a discussion arises among those of the cult over some problem in low-frequency amplification, one invariably finds the interest centred either in the resistance-capacity method or the iron-core transformer, and it is a fact that these two methods, either separately or in combination, are the most popular at the present time. The

advisedly, because purity of reproduction is a quality which appears to vary enormously with the ideas of the person observing.

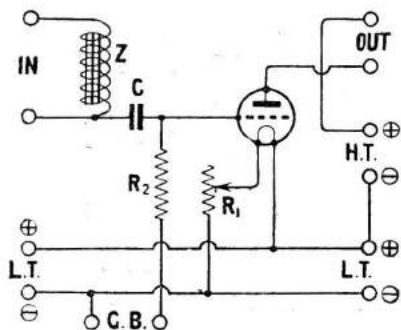
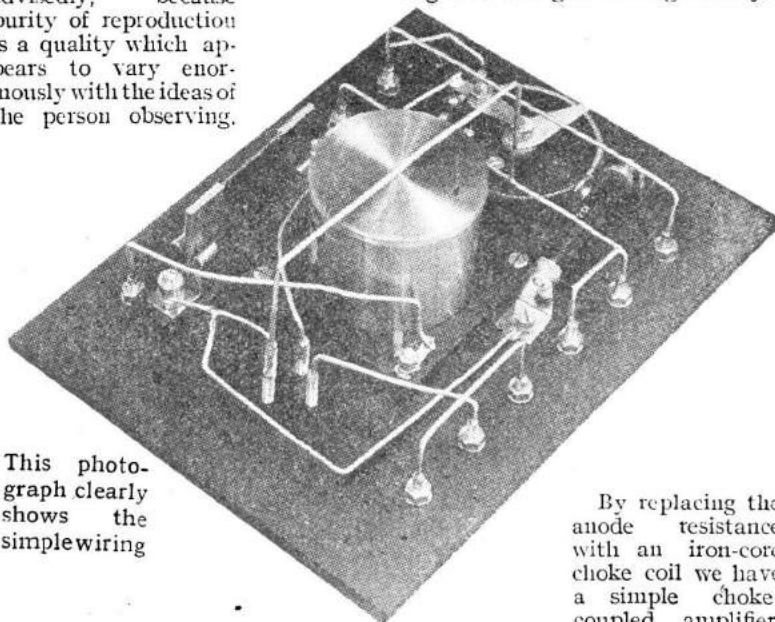

Fig. 1.—The circuit used.

principle of iron-core choke coupling is one which has received little or no attention, especially as regards broadcast receivers, and we would do well to consider this principle and its application to the ever-present problem of obtaining good volume with reasonably pure reproduction. I say "reasonably"

Reproduction which I personally call bad has been brought to my notice as "first class" by people who have at least had some musical training, and I must confess it is beyond me to account for the variation in the standard of quality desired to be reached before the observer calls it "pure." In a transformer-coupled amplifier, the currents in the primary winding induce cur-



This photograph clearly shows the simple wiring

By replacing the anode resistance with an iron-core choke coil we have a simple choke-coupled amplifier.

The voltage variations across the detector valve cause a varying voltage to be set up across the choke coil, and these variations are impressed upon the grid of the low-frequency amplifying valve. The choke coil must have a "resistance" to currents of audible frequency which is very high indeed; that is to say, the inductance of the choke must be high.

An iron core is therefore used, and the winding of the choke coil is put on over this iron core. For those who understand the calculation part of wireless, it may be said that the impedance of the choke (*i.e.*, its "resistance" to speech currents), which may be calculated from the formula $Z=2\pi fL$ where Z =impedance, f =frequency, L =inductance in henries, must be very high, and if we take 500 as the frequency (an average figure) and, say, 50 henries as the inductance of the choke, it is an easy matter to work out Z , which in this case comes out at 157,000 ohms.

The Choke

I have spent a considerable amount of time experimenting with various types of choke, including the secondary winding of all sorts of transformers, and have found that the best results are obtained with a choke coil made for me by the makers of the "Success" transformer. These chokes are now on the market, and may be obtained at a very reasonable figure. For the man who can obtain it, the secondary winding of a "Ford" induction coil makes a good substitute.

In designing the amplifier unit seen in the photographs, simplicity was taken as being the first

essential, while it was decided to make the unit up in such a form that it should be easily duplicated, thereby enabling two such units to be placed side by side and connected up easily.

The Circuit

Look now at the circuit diagram. On the left will be seen two terminals marked "in." These must be joined to the telephone terminals of a valve receiver in a manner to be described later. The

condenser C may have any value from $.006\mu F$ up to about $.25\mu F$, while any value of resistance about 1 megohm will be suitable for the grid leak R_2 . I use $.007\mu F$ and 2 megohms, and am perfectly satisfied. It will be seen that there are two pairs of L.T. terminals. These are to permit of the battery being joined to those on the right, while those on the left are connected to the corresponding terminals on the existing receiver.

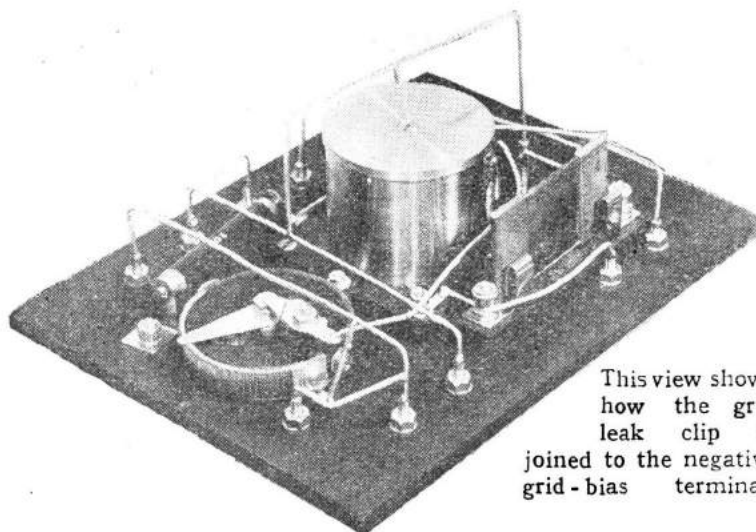

This view shows how the grid leak clip is joined to the negative grid-bias terminal.

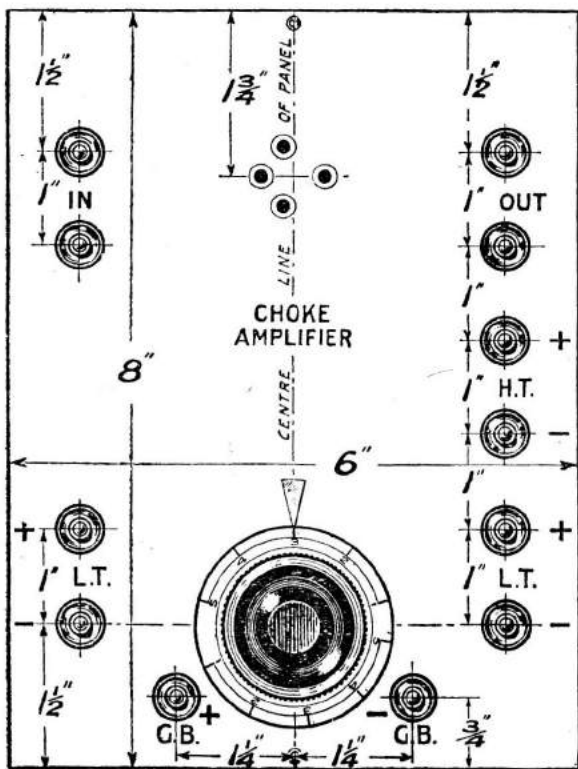

Fig. 2.—How the panel is drilled.

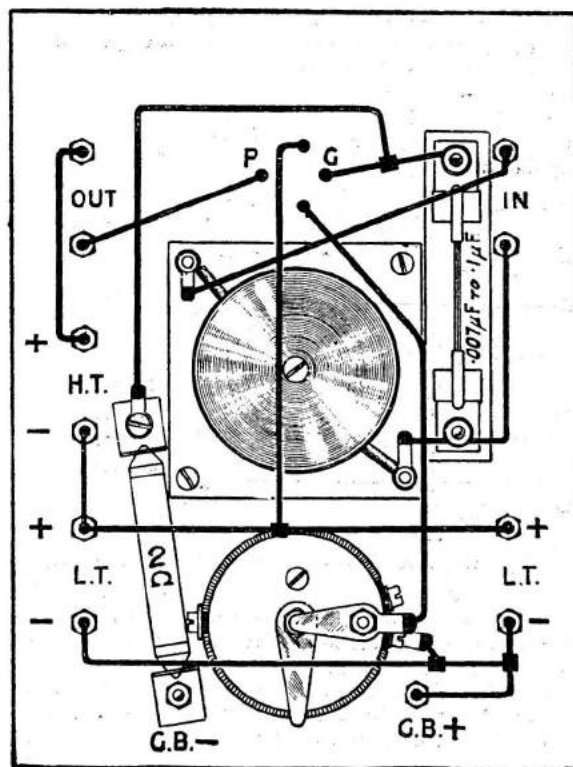

Fig. 3.—The wiring diagram.

Both of these drawings are exactly half size.

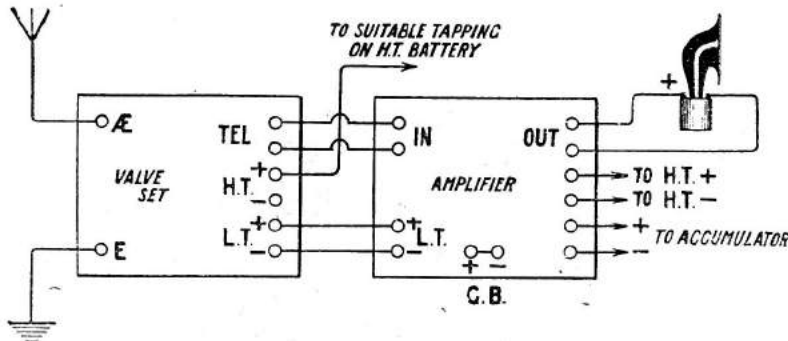

Fig. 4.—Showing how to join up one amplifier unit to a valve set which is already in use.

Components Necessary

There are really quite few parts needed, and a list is given, together with names of manufacturers. Any good make of part may be substituted for those mentioned, but I do not advise you to "try your luck" with other makes of choke, for reasons already given:—

- One ebonite panel, 8 in. by 6 in. by 1/4 in. (Britannia Rubber Co.).
- Suitable box (Carrington Manufacturing Co.).
- Four valve sockets, or one complete holder.
- One filament resistance (McMichael dual type).
- One choke coil (Success).

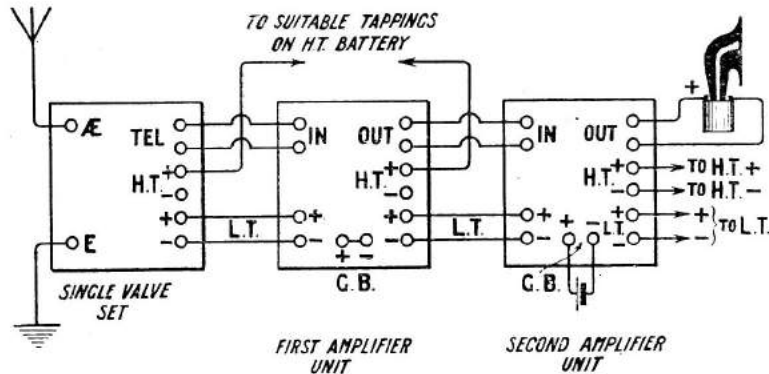
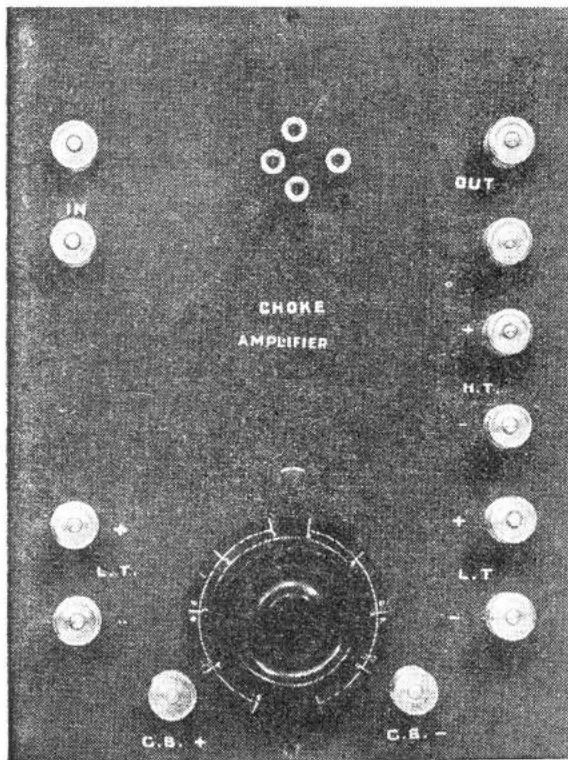

Fig. 5.—How to join up two units to a set which does not already embody low-frequency amplification.



A close-up view of the panel, showing the simple construction.

and the drawings given help to make the work easier. The layout of the panel and necessary holes are seen in Fig. 2, and the ebonite, bought ready cut to size, should be marked out in accordance with this drawing. Don't use a pencil. If you are tempted in this direction, leave all your pencils in a place as far removed from the workshop as possible, and keep your scriber handy.

Blind Holes

You may notice that on the front of the panel there do not appear

One .007μF clip-in condenser and base (McMichael).

One 2 meg-ohm grid leak with clips (McMichael).

Twelve terminals, W.O. type.

One "Decko" dial indicator.

One set Radio Press Panel Transfers.

Screws for fixing choke, condenser, etc.

Suitable wire for connections.

How to Drill your Panel

The layout of this amplifier unit is so simple that it is quite an easy matter to make it up in an afternoon,

any screw-heads, such as are necessary for securing the choke, grid-leak clips, and condenser base to the panel. This is because I delight in drilling and tapping "blind" holes. You won't upset the unit, however, by drilling clearance holes and securing the components with screws which pass right through the panel. The same remark regarding tapping applies to the valve sockets. If you don't use a complete valve-holder, the only satisfactory way to mark out the positions for the separate sockets is by using one of the excellent templates, such as the Morris or the Aeronomic (to mention only two), which are now obtainable quite cheaply. Having mounted up the parts, you can proceed with the wiring, and the diagram given will help you here. Don't try to "improve" the design; It has been worked out with considerable care.

How to Use the Unit

When you have finished making the unit, connect it up to your valve set (which, by the way, should not already contain more

(Continued on p. 539.)

A PICTORIAL GUIDE TO TUNING

*Some useful hints
for the beginner*

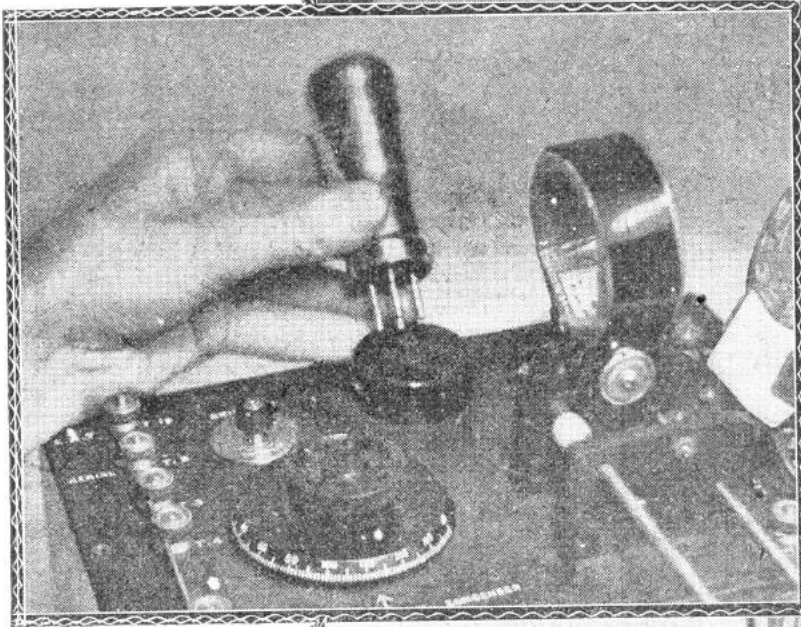
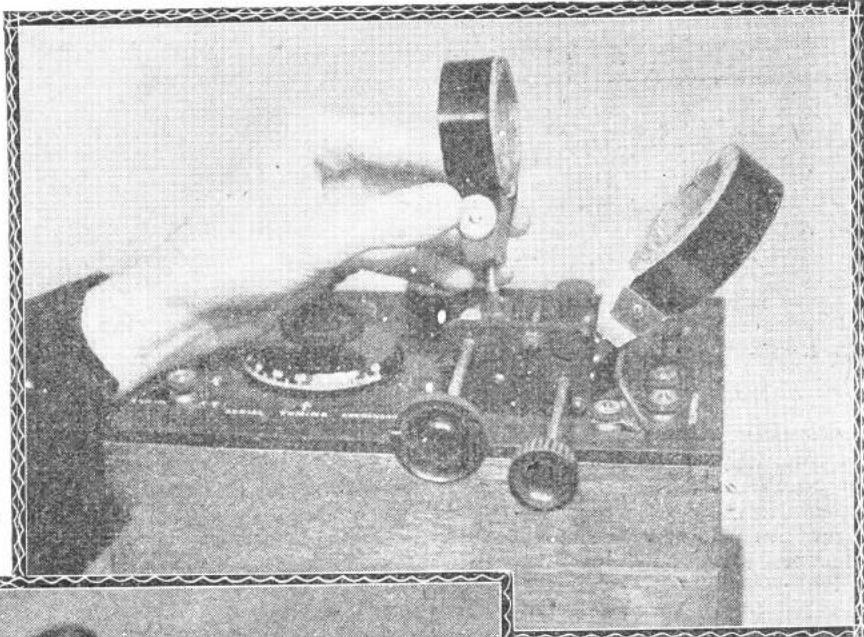

There is a vernier adjustment for what is normally the fixed socket, but this can be ignored at the beginning. Many coil-holders have not such an adjustment.

First of all, then, we must place suitable coils in the aerial and the reaction sockets. For a single valve set the reaction coil should be about one size larger than the aerial coil, this latter being chosen to suit the wavelength it is desired to receive. Owing to differences in conditions, the coil will give different wavelength adjustments on different

ALTHOUGH the process of tuning a set can be described in relatively few words, nothing is better than a practical demonstration, and next to this a series of photographs. The accompanying pictures show a simple single valve set being handled by a member of Radio Press technical staff so as to get the best results in tuning.

In the set shown, the left-hand socket carries the aerial coil, and the moving socket the reaction coil. It so happens that in the particular coil-holder used



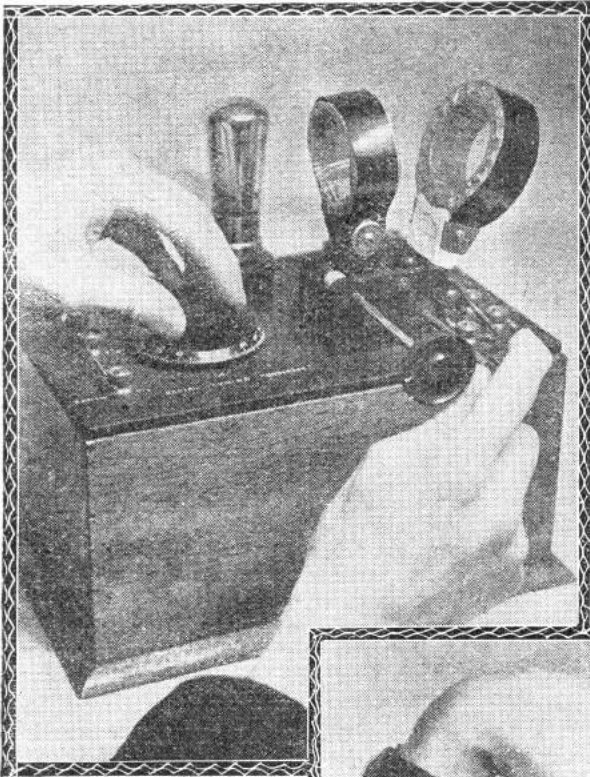

the round portion should not be gripped and squeezed. It is better to act as shown by placing the finger and thumb on the socket rather than on the coil itself.

The next step is to place a suitable valve in its holder, taking care that the unequally-placed pins are not forced into the wrong sockets in so doing. In a previous issue was shown how to place a valve in its socket (November issue, page 57).

Now, before turning on the current, open out the reaction setting by turning the knob of the coil-holder until the moving coil is as far away as possible from the aerial coil (third photograph). Now, with the coil in this position, rotate the variable condenser slowly backwards and forwards until the station it is desired to hear is heard at best strength. If you are some distance from a broadcasting station you may not at first hear the station in this way, in which case you should follow the procedure shown in the fourth illustration, in which the reaction coil is brought a little nearer to the aerial coil by means of the knob shown. The tuning should then be repeated, but if by any chance, in rotating the condenser, you hear a howl which varies its note as you turn, it is a sign

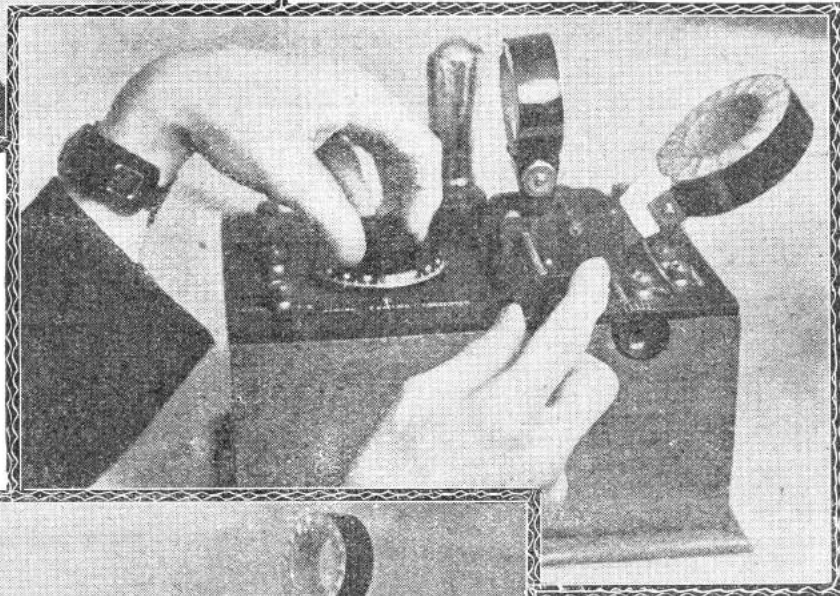

aerials, but generally we may say that any wavelength within the range of 300 to 500 metres can be received on either a 25, 35, or a 50, or its equivalent in those makes which do not give numerical definitions.

Notice particularly that care is required in placing the coil in its socket, and



that the set is oscillating, and you should open out the reaction coil until this effect is eliminated.

The last photograph, whilst it looks innocent enough, illustrates how disaster may come upon the beginner, for here we see just what happens when he starts to dismantle his set to look at the wiring. The moral is, of course, when taking your valve from a set to lay it somewhere where you are perfectly sure it will not be knocked or pushed off the table!



Mr. R. E. Jeffrey, the Dramatic Director at the London Station.

Broad-casting and Drama

By "CARRIER-WAVE"



Miss Cathleen Nesbitt, one of the Pioneers of Broadcast Drama.

MOST people will admit that the two essentials for ideal wireless reception are—a first-class set and a healthy imagination. Given the above factors, we shut our eyes, and see Paylova dancing to the ballet music at Covent Garden, watch the gaily clad dancers at the Savoy Hotel, and follow all the mediæval heroes and heroines of our favourite operas; and until television is made possible, we are fain to be content.

Illusion

But when it comes to drama, the B.B.C., like unto the Fairy Godmother of old, waves her wand, or shall we say, perhaps, shakes her aerial, and declares that to the bread of imagination she will add the sweetening influence of illusion. In consequence, when we descend metaphorically into the coal mine of "Danger," we hear the rushing of the waters that swamp us, the creaking of the descending lifts to our rescue, while for other plays we have heard the motor that never

fails to reach us in the nick of time, the runaway horse, or the vivid storm that coincides so frequently with the weather report.

The First Play to be Broadcast

The only question that arises after we have turned up the lights,

Society of Great Britain to establish a small broadcasting station for experimental purposes at Writtle, near Chelmsford, he himself established the installed by broadcasting excerpts from "Cyrano de Bergerac."

Opera

When the B.B.C. came into existence, and 2LO, in the shape of a 100-watt set, was installed in the cinema theatre of Marconi House, Strand, a tremendous experiment was made with the first attempt to broadcast opera from Covent Garden, where a season was being held by the British National Opera Co., and a very successful experiment it proved. From that time onward both plays and opera have become a very vital part of every programme, and one of the earliest attempts when 2LO was transferred to Savoy Hill was to arrange Shakespeare's "Midsummer Night's Dream," and on July 25, 1923, in addition to the various members of the Staff, Mr. Rex Palmer, Arthur Burroughs, and others—the well-known theatrical stars, Ernest Milton, Cathleen Nesbitt (who arranged the whole production), Nigel Play-



At first a barrister, Mr. Nigel Playfair has contributed largely to broadcast drama.



Mr. William Macready, the well-known Shakespearean actor, is the Dramatic Director at Birmingham.

and mopped our moist brows, fevered as we carefully explain by the heat of the room, and not the shrieks of the tortured heroine, is, how is it done? And that is the problem which the B.B.C. and its clever band of assistants has endeavoured to solve.

As a matter of fact, the play-broadcast is one of the very oldest of all the items on the programme; indeed, it may be said to be the first programme ever broadcast, for in 1922, when Captain Eckersley obtained permission for the Radio



Mr. R. T. Fleming, a successful actor, at the Manchester Station.



Mr. Victor Smythe, the Director of Plays at Manchester.

A chat about broadcast plays and those who have made them successful



Miss Dorothy Franklin, who is well known to Manchester listeners.

fair, Ivan Berlyn, amongst them, gave wonderful assistance. At that time it was thought sufficient to give us just the actual lines and the music of Mendelssohn, and it is a far step to the performance of "The Tempest," given just recently under the direction of the Dramatic Director, Mr. R. E. Jeffrey. A star cast, including Ernest Milton and Moyna Mac-Gill, was again utilised, but he also had the assistance of a trained band of "sound-makers."

So that all we had to do was to close our eyes, and we had Prospero's island, with its storms, its waves, and the stress and strain of weather we have been experiencing ourselves, indeed, we almost expected him to tell us that his "further outlook" was also "unsettled." The sounds, however, which so faithfully represented it were in reality very simple devices. A rotating wheel, covered with bands of canvas, revolving at varying speeds made the wind, and a large shallow drum, filled with buckshot, when tilted in the hands of the expert, reproduced the waves breaking on the shore and their backwash again. Thin sheets of metal gave us the thunder, literally, as "Alice in Wonderland" would have said, "rolling round in heaps."

Other plays, of course, require

other devices, and, where the loud splashing of water is necessary, use is made of a lead tank of real water which, although only about eight feet long and five wide, is quite sufficient to give most terrifying sounds for shipwreck scenes.

Sound Effects

A railway train travelling at high

strictly to the "beat" of the conductor, who has carefully rehearsed every movement, give us the thrills necessary.

Mr. R. E. Jeffrey

Mr. R. E. Jeffrey has indeed brought these "effects" to a very high pitch of art at 2LO, to which station he was transferred as

Dramatic Director from Aberdeen, to the keen dismay of listeners in that area. Few producers have had wider or more varied experience, for he has long been one of the foremost figures in the Scottish and London entertainment world. As author of books, as actor—he has played the part of "Raffles" alone some four hundred times—and as producer, when at the Aldwych Theatre he presented in 1920 "Macbeth," with Mrs. Pat. Campbell, in conjunction with Gilbert Porteous, "La Tosca," with Ethel Irving, and with Viola Tree, "The Unknown," as well as one of his own plays, "The Dragon," it is evident that Mr. Jeffrey is particularly the right man in the right place.

Miss Cathleen Nesbitt

Of the earlier pioneers of wireless drama, Miss Cathleen Nesbitt, the well-known actress, stands out, perhaps, most prominently, for she



Producing a play at 2LO. This photograph shows some of the "sound effects" being produced. Mr. Nigel Playfair is on the extreme right.

speed is imitated by a pair of ordinary roller skates pressing against a rotating drum, a clatter of hoofs with two pieces of board, pails of broken glass, and hollow pipes with rattling chains are all utilised to give the effect of distant sounds. A vigorously squeezed paper-basket gives an excellent imitation of rickshaws, and these in the hands of experts, and made

arranged so many of the Shakespearean plays for wireless purposes.

"A Midsummer Night's Dream," "Romeo and Juliet," and "The



Mr. D. E. Ormerod, Assistant Producer at the Manchester Station.

Merchant of Venice" were arranged for 2LO by her, and she herself played Titania, Juliet and Portia. On the actual stage she has played all over the world, and was with the first repertoire company, "The Irish

ing some experience with the Oxford Union Dramatic Society, the Old Stagers and the Windsor Strollers, all famous amateur societies. He admits that he made his first appearance professionally at the Garrick Theatre in 1902 in the capacity of "noise without," but fame has come since, and amongst his numerous successes may be mentioned the plays "His House in Order" and "The Knight of the Burning Pestle," in which he played the part of Ralph, his favourite part. For broadcasting purposes he superintended the whole production.

In the Provinces

Drama, however, has played an even bigger part in the provinces than at 2LO. Manchester and Birmingham have been especially energetic in this direction.

At Manchester, Mr. Victor Smythe has been the producer of all the Station plays, amongst them being "Captain Swift," "A Butterfly on the Wheel," "The Witness for the Defence," with countless others, and for these he gathered round him a select little company of stock players, which included Dorothy Franklin, as leading lady, a young actress especially gifted for emotional parts. It is said there that if she

dramas. He has been also assistant producer to Mr. Smythe.

Another clever 2ZY actor is Mr. R. T. Fleming, and has been successful not only at "dude" parts, but "heavy" as well, as was instanced by his outstanding performance



Miss Edna Godfrey Turner, the wife of Mr. W. Macready, has contributed largely toward the success of broadcast plays.

of the dual roles of Stephen Ballantyne and Dick Hazlewood in "The Witness for the Defence."

Birmingham

5IT has been exceptionally lucky in having the assistance of the best known Shakespearean actor William Macready (and who is now Dramatic Director at Birmingham), and his charming wife, known professionally as Miss Edna Godfrey Turner.

Their legitimate stage work is too well known to need detailed comment, but on their broadcasting work it is impossible to dwell too strongly. They have had the strongest companies to assist them, and every possible "sound method" at their command. They were the first to broadcast a play by Hall Caine ("The Christian"), and the famous "Under Two Flags," of Ouida, and surely no more difficult play could be imagined for wireless purposes. Yet the "sound effects" were all obtained, the sand storm of that last ride of Cigarette being perhaps one of the best. Other plays include "The School for Scandal," "She Stoops to Conquer," "David Garrick," "Othello," "Caste," "Tale of Two Cities," "Moths," and a whole host of farces. When it is remembered that these two artists have a Shakespearean repertoire of over 300 scenes, which are given without the aid of the book, it is little wonder that they have been welcomed at all Stations, and they can fill an entire evening without touching Shakespeare at all. They have indeed made broadcast drama the triumph it is.



The B.B.C. car which provided music during the Lord Mayor's procession in 1923.

Players." To her immense repertoire she has now added her part in "Spring Cleaning" at the St. Martin's Theatre.

Mr. Nigel Playfair

Mr. Nigel Playfair, who gave us those three Grand Guignol plays last year, was at first a barrister, but turned to the stage, after gain-

ing a rôle that demands her crying, she cries hard, and when one remembers that there is no one in the studio, one can realise that she is really lost in her part. Mr. D. E. Ormerod joined the 2ZY players in the very early days, and played in "A Midsummer Night's Dream," and all the other powerful

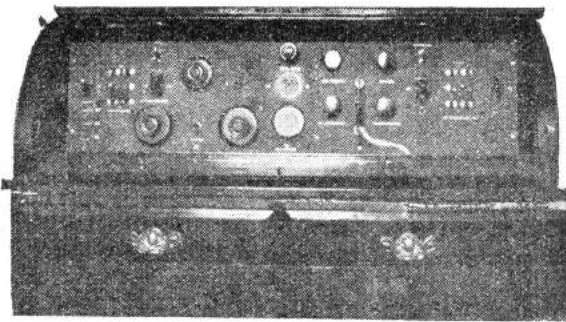

The handsome receiving set operated by the author.

Some Notes on Crystal Reception

By V. PETTY

The simplest crystal circuit, if carefully designed, can be made to give really excellent results, as these notes show

RECENTLY the humble crystal has come into the limelight again, and there have been developed many circuits which give excellent signals.

The writer has been experimenting with crystals for some time past, and a plain crystal circuit has been included in the four-valve set, a photograph of which is reproduced herewith. A diagram of the circuit used is shown below, and, as will be seen, nothing out of the ordinary is incorporated. The coil is of the solenoid type wound with 18 D.C.C. on a 4-in. ebonite former, and contains 31 turns. No shellac varnish or other binding medium was used. The tuning is effected by means of a .001μF. variable condenser. The number of turns for the coil was determined by experiment to give the maximum signal strength (R.9) from 2LO, using 5 degrees of condenser. There are no tappings taken, but provision is made for a loading coil on the aerial side.

Some Results

Now as to the results. I am situated 6½ miles from 2LO in a

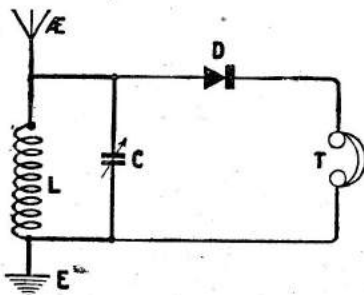

The circuit used is perfectly straightforward.

S.S.F. direction, and the neighbourhood is badly screened, owing to the proximity of the Crystal Palace and a large number of tall trees. However, in spite of

these adverse conditions, Radio-Paris comes in on the crystal set regularly, and is loud enough to be enjoyable, provided everything is fairly quiet. Glasgow is also received fairly regularly after the local station has "signed off," when they relay dance music from Gleneagles, which is about twice a week. That is about 400 miles away. Aberdeen was heard quite plainly on September 9, 1924, the concert ending about 8 minutes

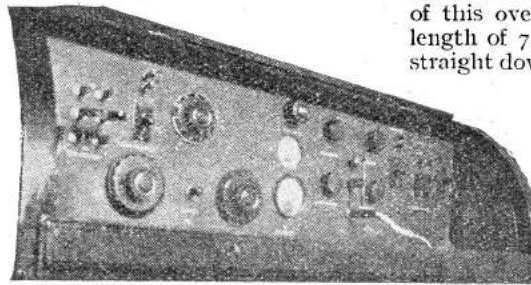

Another view of the valve set.

after 2LO had finished. Other B.B.C. stations have been heard during the Children's Hours, but were not identified, as they do not give the call signs on these occasions.

Madrid

The climax was reached, however, when, on September 9, at about 11.35 p.m. Madrid was tuned in, 800 miles away. I confirmed this by switching over to the valve circuit. This station, by the way, comes in very loud on a single valve. When I say I heard it on a crystal, I do not mean to say that it was loud enough to enjoy, but at times was loud enough to hear and distinguish the words spoken, and tunes could be recognised. I repeated this performance on eight consecutive evenings, so you see that the possibility of it being a freak result is "washed out."

Now for the reasons why these

results are possible, or, at least, the only reasons that I can think of. First of all, the aerial. This is supported between two masts. One is about 35 ft. high and the other is a 16-ft. pole on the roof, making it 60 ft. from the ground. The aerial is made up of three lengths of 7/22 each 85 ft. long, but they are not supported on spreaders. They are twisted together, so as to form a single length which consists of 21 strands of No. 22 wire. There is no doubt as to the advantage of this over the more usual single length of 7/22. The lead-in comes straight down from the end, through the window frame and on to the set, being about 13 ft. long (the lead-in, of course, not the set).

The method employed in twisting the wires might prove interesting. The three lengths were measured off and fixed to the mast at the end of the garden, about 4 ft. from the ground. The other ends were taken together and fixed into the chucks of a twist drill, and by turning this the obvious thing happened. The wires were bound round in about eight places to keep them from untwisting. A word of warning here would not be out of place. Great care must be taken to secure both ends of the wires properly during the twisting business, as should they come unanchored whilst under tension, they might cause considerable bodily harm to anyone who happened to be in the way, as they would fly about in all directions with plenty of force. Another important item to consider in crystal reception is the telephones. Personally I use a pair of foreign light-weights. The only

objection to these is obvious, but I cannot find anything else to compare with them at the price. I know one can obtain goods of British manufacture as good as or even better than the above, but my pocket is not long enough. The detector is not a matter of vital importance, and I use the ordinary open type that costs about 9d. I find it easier to manipulate than the expensive micrometer adjustment affairs, and quite as stable. The crystal itself is a ninepenny piece of well-

known make and has been in commission now for some months. Any fine-pointed whisker will work wonders with a good piece of crystal.

Reception of 2LO on a Crystal

The only comments necessary on reception from 2LO are that the crystal set alone works the loud-speaker at comfortable strength for a small quiet room.

In conclusion, I would like to point out that this is not a campaign against any of the "stunt"

circuits which have been published recently. I have not tried any of them, so cannot offer any opinions. Rather, it is intended to illustrate what can be done with a plain straight circuit and a good aerial.

I know quite well that many readers will think some of the results impossible, especially the 800-mile business. I expect I should. But to back my statements I am quite willing to give a demonstration by appointment (one at a time, please).

Where Wireless is a Boon

By SYDNEY WILDMAN

FAR away, off the north-east coast of Scotland, there lies a small group of islands known as the Orkney Islands.

Many of the islands are inhabited, but there are some which are so desolate and so wind-swept that, save for a few sheep which graze on the scanty pastures, and are visited now and again by shepherds, they are totally deserted. Countless sea-birds make some of the smaller islands their home, and their shrill cries can be heard above the roar of the seas against the forbidding coasts.

Kirkwall and Stromness are the only two towns of note on these islands. Kirkwall is the chief town, and is situated on the Bay of Kirkwall.

The history of the islands goes back to the days of the fierce Vikings and Norsemen, and many a fight has taken place around the rock-bound coasts of Orkney.

Lonely Islanders

A stretch of water known as the Pentland Firth separates the islands from the mainland, and it is across the Firth that the supplies, mails and newspapers have to be brought to the islanders. Very often the sea is so rough that no boat can cross, with the result that the Orkneys, save for telegraphic communication, are cut off for days at a time.

Before the introduction of broadcasting, these islanders led a very drab existence and had to rely on their own resources for amusement. Now, all is changed. Every evening, those of the inhabitants who have wireless sets tune in to Glasgow, Aberdeen, or even London, and listen to the latest news, and dance to the strains of the Savoy

bands, playing five hundred miles away.

People who live in the great cities and towns of Great Britain, and who are used to theatres and

cinemas and all the bright things of life, have no idea what a boon broadcasting is to the few inhabitants of the Orkney Islands and other isolated spots off our coasts.

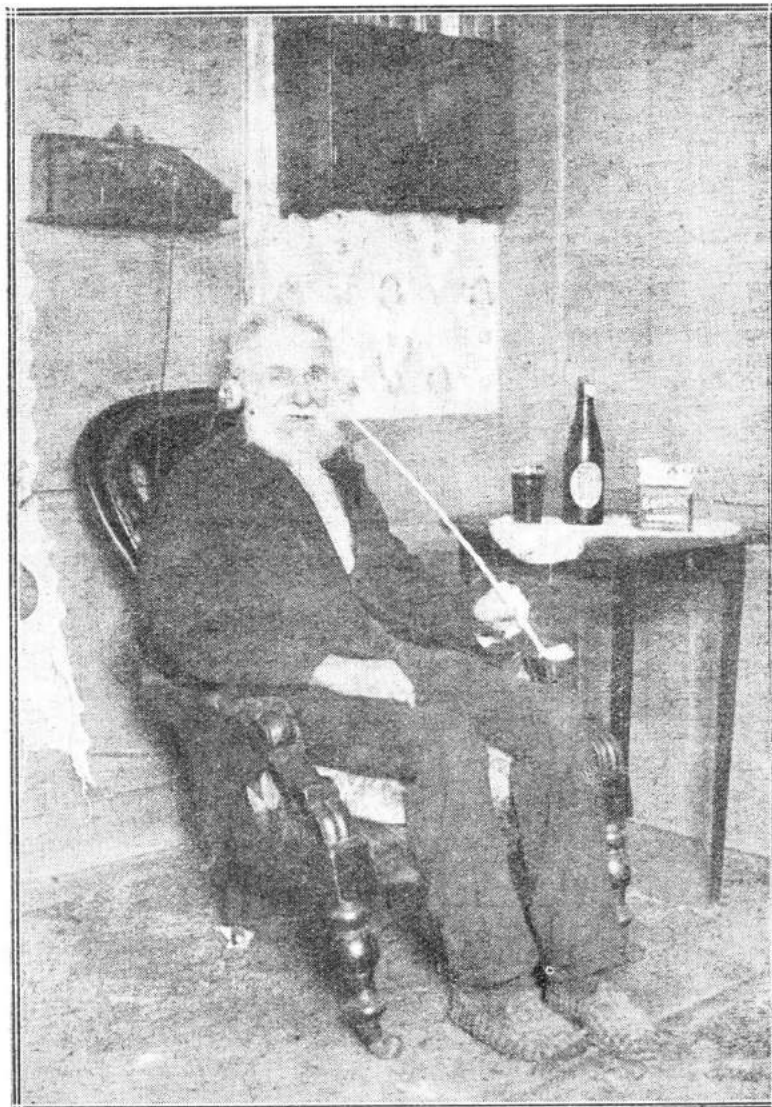

A retired Navy man, Mr. J. Rothwell, heard with interest the recent "Songs of the Sea" programme from 2LO.

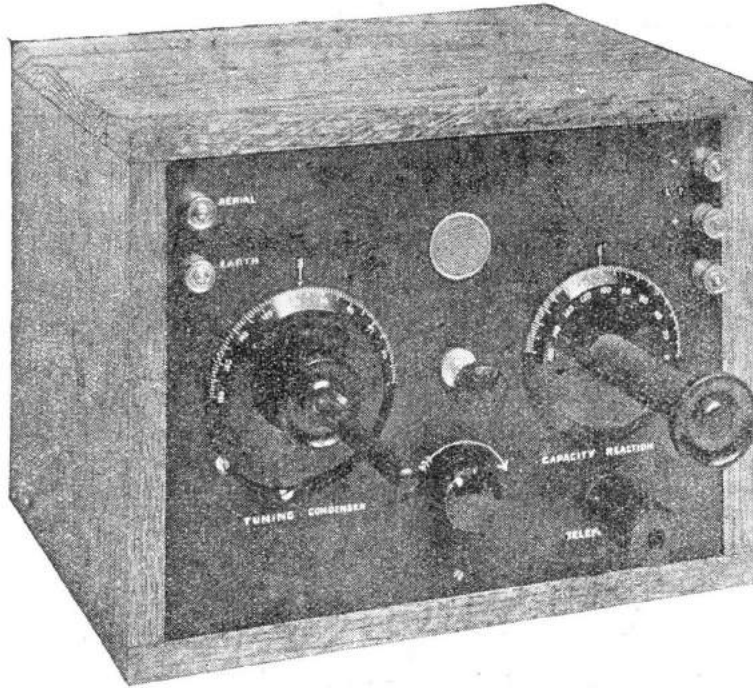

The extension handles are a necessity for accurate tuning.

FOR THE SHORT-WAVE EXPERIMENTER

*A Receiver for Wave-
lengths between 40 and
210 metres*

By
C. P. ALLINSON

THE design of a short-wave set is one that allows for a wide scope as regards the choice of circuit, there being various forms of Reinartz that enjoy great popularity as well as the straight-forward magnetic reaction receiver,

and though this has not been entirely overcome in the receiver about to be described, it is kept within easily controllable limits. Thirdly, it was desired to make the tuning coil or coils interchangeable, so as to cover a far wider band than is possible with a single coil. The use of a tapped coil was decided against in view of possible dead end losses, and the use of a switch for cutting out part of the coil in order to receive lower wave lengths was found undesirable. Fourthly, it was desired to employ the "Harris" type of

X coil, which has been found so efficient on short-wave work.

The Circuit

The circuit finally evolved was that shown in Fig. 5, and will be seen to be a modified Hartley circuit. The aerial coil L_1 consists of four turns of 18-gauge d.c.c. copper wire coupled loosely to the secondary coil L_2 , which consists of 20 turns of the same wire made up as described further on. It will be noticed that

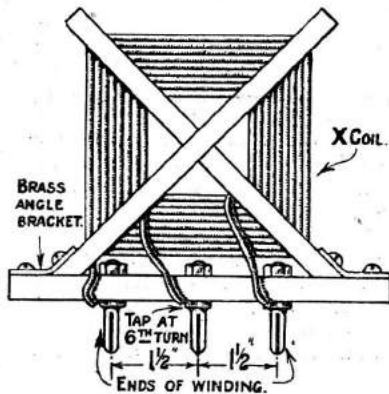
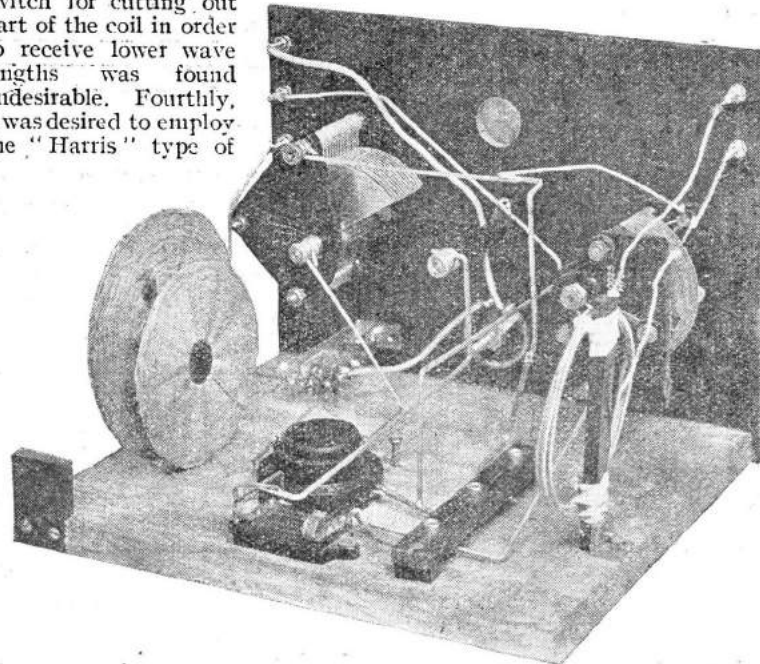

Fig. 1.—Details of the interchangeable tuning coil.

The question was complicated in the writer's case owing to several conditions with which it was intended that the receiver should comply. First of all, a loose-coupled circuit was a *sine qua non*, as a very bad earth hum is experienced when using direct or auto-coupled circuits. Secondly, it was found that magnetic reaction in most cases caused an enormous alteration in tuning with even the slightest variation in coupling between the reaction coil and the secondary,



The set removed from the cabinet. The basket coils form the choke coil in the plate circuit.

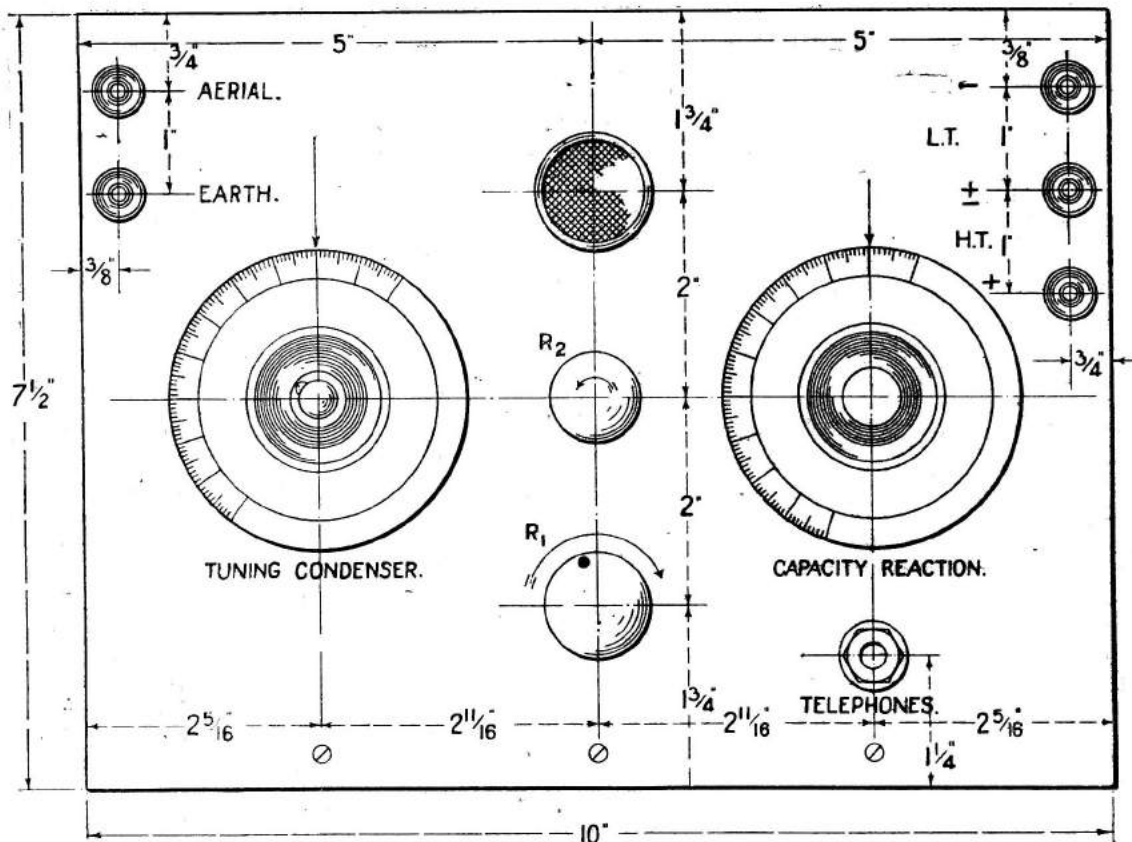

Fig. 2.—Showing how the upright panel is drilled. All necessary dimensions are given.

the filament tap is not in the centre of this coil, as is usual in the Hartley circuit, but much nearer the plate end of the coil. This was found necessary, as otherwise reaction was fierce and uncontrollable. The actual number of turns used was arrived at after considerable experiment, as also in the other coils which were used to cover other wavelengths.

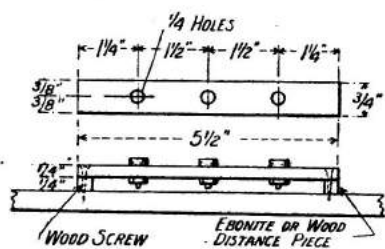

Fig. 3.—Details of the ebonite strip which acts as a coil holder.

A word of explanation as regards these may not be amiss. The 20-turn coil was found to cover the wave band between 75 and 210 metres. This was necessary in order to receive the 200-metre transmissions from amateurs. The 65-metre transmissions from KDKA, however, required another coil; this was, therefore, wound with only 10 turns, and brings in

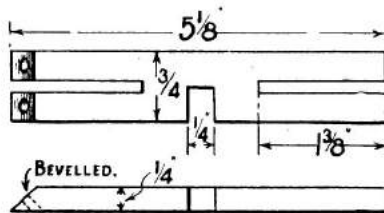

Fig. 4.—The ebonite strips used for the X coils.

the above station at about 80 deg. on the tuning condenser, the minimum wavelength receivable being in the region of 40 metres. It was found possible to get the set

to oscillate with a coil L_2 of only five turns, though this, of course, required a rather higher plate voltage than that usually used. Both these last coils needed the filament tap to be in the centre of the coil. Next, it was decided to see if reception on the broadcast band could be obtained with any degree of efficiency, and therefore an 80-turn coil was made up with several tappings toward the plate end of the winding, the correct point for the filament tap being finally found at 8 turns. This was found to give excellent results on London (2L0); other B.B.C. stations were also easily received, but

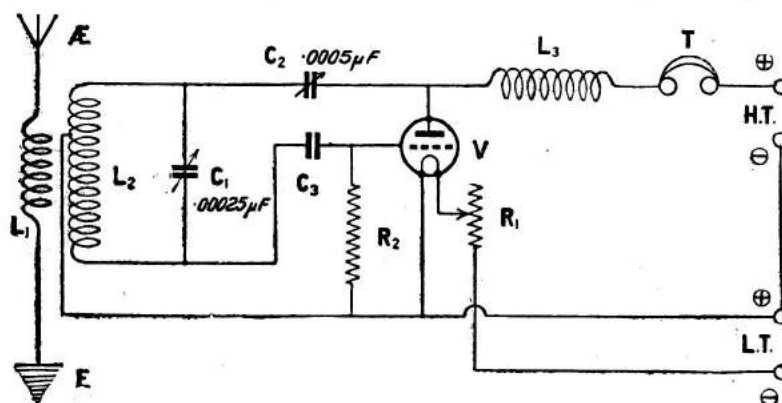

Fig. 5.—The circuit is a form of Hartley.

Nine valve pins.
Five nickel terminals (Burne-Jones).
Square tinned copper wire for connections, a small brass strip for mounting the coils and a strip of ebonite for the primary.

Radio Press Panel Transfers.
Though this may appear a rather long list of components, the actual cost of this receiver will be found to be very reasonable, and the results obtainable will be found well worth the outlay.

If guaranteed ebonite has been obtained, the panel may be marked out and drilled right away, otherwise first prepare the panel by removing the shiny surface with No. 0 sandpaper, rubbing in one direction only. Both sides of the panel should be treated in this manner. Next apply transfers if you wish to use them and attach the components to the panel. The $\frac{3}{8}$ in. ebonite rod is used for the extension handle for the vernier control of the tuning condenser,

The other end can be knurled, and gives a firm grip.

The various components that go on the base board should next be fixed and the panel fixed to this by means of three $\frac{1}{2}$ in. \times 3 in. wood screws. The "coil-holder" with the three sockets should be made next, and a dimensioned drawing of this will be found in Fig. 3, and needs no further instructions. Before fixing this to the base board, however, three short pieces of wire should be fixed under the nuts of the sockets in order to make connections to them. The primary coil can now be wound. This consists of four turns of 18 gauge d.c.c. wire wound on a 3 in. former, slipped off and tied together and fixed to a strip of ebonite about $4\frac{1}{2}$ in. long with string. This is mounted to the base by means of an angle bracket as shown in Fig. 9. The two basket coils are mounted by inserting a slip of wood into one of the spaces between the turns of wire, drilling two small holes in the base board and forcing the wood slips into them. Care should be taken to see

saw, two blades being used side by side to make the slot wide enough to take the 18 gauge wire. The 200 to 80-metre coil is 20 turns of 18 gauge d.c.c. wire, with a tap at the 6th turn from the beginning of the winding. This is made by twisting a loop in the wire about 3 in. long, the winding then being completed.

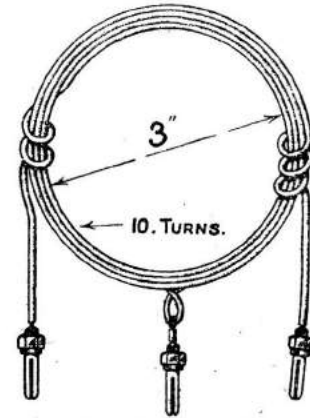
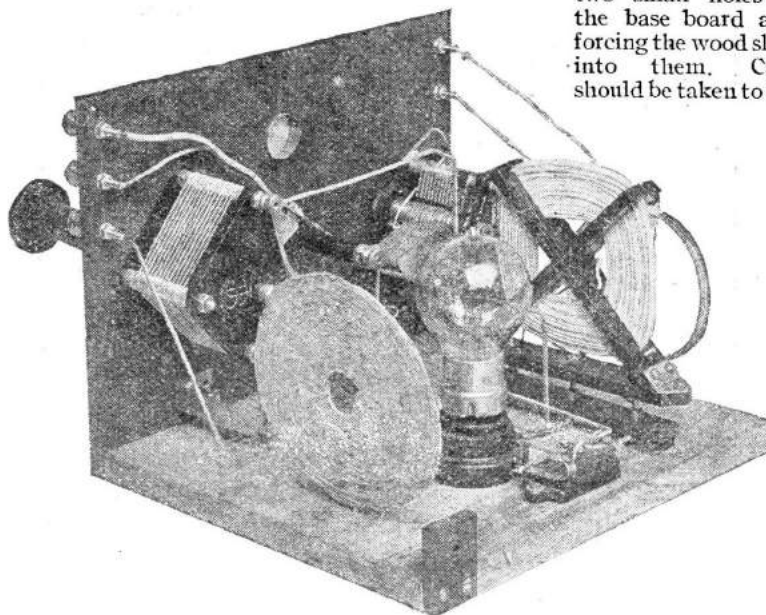

Fig. 7.—Showing the appearance of the completed 10-turn coil.

The two ends of the winding and the loop are fastened under the nuts of the valve pins which are secured to the mounting strip $1\frac{1}{4}$ in. apart in the order shown in Fig. 1, the coil being fixed to the mounting by means of two brass strips, bent as in the same figure. The B.B.C. wave coil is made in a similar manner, 80 turns of 24 wire being wound on and a tap taken at 8 turns from the commencement. The smallest coil consists of 10 turns of the 18 gauge wire 3 in. in diameter with the tap taken at the centre, and is made self-supporting by twisting the ends of the winding round the coil, and the valve pins attached straight to the wire. It will be found that the wire is quite stiff enough to support the coil without any former or ebonite



A view showing the tuning coil in position.

and has a clearance hole drilled up one end suited to the spindle of this control. A hole is drilled in the side with a 6 B.A. tapping drill, tapped 6 B.A. and a small screw inserted to lock the extension handle on the vernier spindle.

The Second Handle

The other piece of ebonite, which is 1 in. thick, may be turned taper at one end if a lathe is available, and a 2 B.A. tapping hole drilled in the small end. This is tapped out 2 B.A. and screwed on to the spindle of the reaction condenser.

that the windings are in the same direction, in which case the inside end of one will be connected to the outside of the other.

The set may now be wired up according to the wiring diagram shown in Fig. 6. This is a perfectly straightforward matter, the leads being few and well spaced. Only remains now to construct the necessary tuning coils. The construction of the formers for these is quite simple, fully dimensioned drawings of the ebonite strips being given in Fig. 4. The slots to take the wire may be cut with a hack

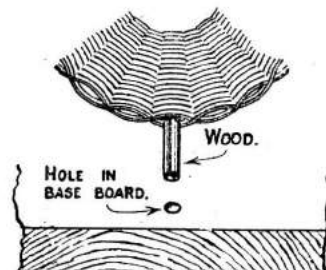

Fig. 8.—Showing how the basket coils in the plate lead are mounted.

mounting. When plugging in the two larger coils they should be inserted so that the valve pin attached to inner end of the winding

LISSENIUM

In comes a melody—

From farther away it comes to you, as you turn the LISSESTAT knob, and clearer, stronger, until you have reception at its best. The powerful penetration of your receiver depends upon LISSESTAT control as part of its equipment. With no other filament control can you duplicate its performance. Its critical command over electron emission improves the reception of distant telephony in a marked manner.

To those who think LISSESTAT control is the same thing as an ordinary rheostat—let them try the difference.

Varying Grid Leak Value—

The grid leak value required for weak or distant stations is different to that needed on loud or nearby transmissions. For instance, to receive American telephony, the grid leak could even be as high as 10 or 12 megohms. The LISSEN Variable Grid Leak is the only one with which it is possible to obtain this high value, as well as the low minimum of $\frac{1}{4}$ megohm. Not only has it got a wide range, but it is constant and

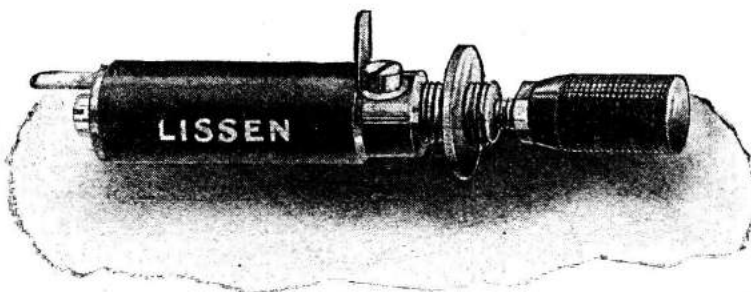

accurate, and gives absolute control over grid potential under all receiving conditions. It is a necessary fitment in every sensitive receiver. Range $\frac{1}{4}$ to 15 megohms.

LISSEN ONE-HOLE FIXING, OF COURSE - - - - - 2/6

LISSEN Variable Anode Resistance, 20,000 to 250,000 - - - - - 2/6

A LISSEN Variable Grid Leak across the secondary of the last transformer or across the loud speaker itself will smooth out any loud speaker distortion.

LISSEN Matched Neutralizing Transformers

The LISSEN MATCHED NEUTRALIZING TRANSFORMERS described by Mr. W. H. R. TINGEY in "Wireless Weekly" are now ready for delivery. The first range ready is the "A" range, which covers the Broadcasting band. The transformers should be ordered in a set of three, the separate coils making up the set being known as A1, A2, and A3. The letter identifies the wavelength range ("A" for the Broadcasting band), and the number the position in which the transformer is used in the receiver. Price, per coil, £1; set of three £3. Other ranges will soon be ready.

DON'T MIX YOUR PARTS—there is a LISSEN Part for every vital place.

LISSEN LIMITED,

30-32, Woodger Rd., Go'dhawk Rd., Shepherd's Bush, LONDON, W.12.

Telegrams: "LISSENIUM, LONDON." Telephones: Riverside 3380, 3381, 3382, 1072.

Sold in three models:



LISSESTAT MINOR (patents pending)—is replacing thousands of inefficient rheostats—LISSESTAT control at a popular price .. 3/6



LISSESTAT MAJOR—gives the most acute tuning possible .. 7/6



LISSESTAT UNIVERSAL—with its protective device for dull emitters 10/6



*Brandes Superior
Matched Tone
Headphones*
PRICE NOW
20/-

*British Manufacture
(B. B. C. Stamped)*

All Brandes products carry our official money-back guarantee, enabling you to return them within 10 days if dissatisfied. This really means a free trial.

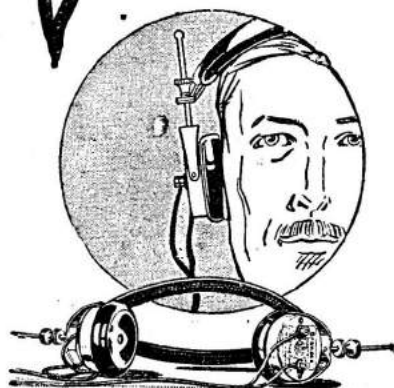

Brandes' Superior *Matched Tone* Headphones are admirably versatile. It's hard to imagine them fitting snugly to the tenderest curly head and yet fulfilling their duty on the head of the expert who sits down to long hours of serious experiment. So comfortable and with a rugged strength of construction to protect their delicate adjustment, they are excellent for family use. Primarily designed for long-range telephony from expert technical knowledge, their *Matched Tone* feature brings in the most distant signals with purity and strength. The experimenter finds that they bring the best results in trans-Atlantic and trans-Continental reception. One gentleman writes from Walton-on-Thames: "I received Australia on Brandes', and consider they are the most sensitive 'phones I have used. I am much pleased with their general performance." *Ask your Dealer for Brandes.*

The Table-Talker is another Brandes quality product at moderate price. Its full round tones are wonderfully clear and pleasing. The horn is matched to the unit so that the air resistance produced will exactly balance the mechanical power of the diaphragm. This means beautiful sound balance. Gracefully simple of line, it is finished a shade of neutral brown and is twenty-one inches high.

.....everyone of these advertisements will show an added advantage in the construction of Brandes Headphones.

Look at the illustration above. See how snugly the 'phones fit the head. A gentle pressure on the crown, a firm clasp to the ears, and the rest of the headband is held well away from the hair. This means long-wearing comfort and the shutting out of extraneous sounds. Strength and firm beauty of lines typifies their finished construction.



Table-Talker
42/-

Brandes

The Name to know in Radio

Brandes Limited, 296, Regent Street, W.1
WORKS : : : : Slough, Bucks



Superior "Matched Tone" Headphones

TRADE MARK

is inserted into the socket nearest to the panel.

Testing

The set can now be tested out. Connect the L.T. leads to their respective terminals and see that the valve lights up correctly when the telephone plug is inserted into the jack. Next, attach aerial and earth leads, plug in the desired coil, place the tuning condenser at about 20 deg. and the reaction condenser at the same value, j in up the H.T. battery and insert the telephones. A suitable value of H.T. will be about 60 to 80 volts with a general-purpose bright emitter. On increasing the value of the reaction condenser the set should go smoothly into oscillation; if, however, it goes over with a "plock," the value of the grid leak should be altered till reaction is smoothly controllable. When receiving B.B.C. transmissions the set should not be allowed to oscillate, of course, for reasons that must now be familiar to most of our readers, and it will be found quite a simple matter to adjust the two condensers together, keeping the set just off the oscillation point.

On the shorter wave bands a great deal of interesting reception can be obtained even by the amateur who has no knowledge of Morse. Harmonics from the local broadcast station can be picked up and form a convenient means of calibrating the receiver; several foreign stations are to be found transmitting telephony in the neighbourhood of 100 metres, amateurs working telephony are to be heard after broadcasting hours, and last, but not least, on the smallest coil KDKA will be found

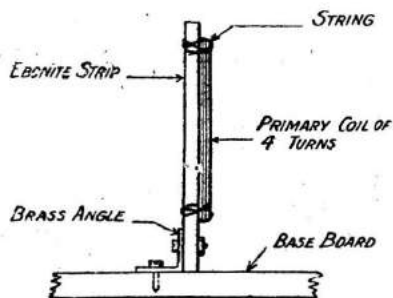

Fig. 9.—How the primary coil is mounted.

at good strength under normal conditions at 11.30 p.m. on about 65 metres.

Short Waves

In searching on the short wavelengths the tuning condenser should be turned very slowly and the

reaction condenser adjusted so that the set is only just oscillating; otherwise carrier waves will be passed over. The use of the vernier adjustment on the tuning condenser will be found almost a necessity, and, as this is employed

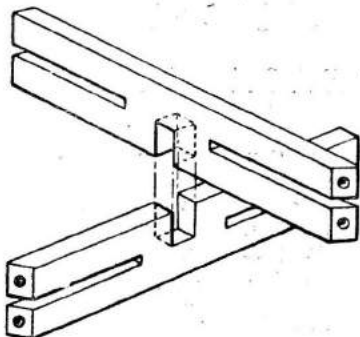

Fig. 10.—How the strips of the X coil are mounted.

for making the final adjustments, the extension handle will be found most useful.

American Stations

With this receiver the writer has picked up as many as a dozen American amateurs between 10 and 11 p.m.; some have also been received as early as 9 p.m. under favourable conditions. These are usually found on the 80 metre wave band, and sometimes, with three or four coming through at once, it is rather difficult to separate them as they all appear to come in at about the same strength.

As the set described has been the result of some months of experimental work, the author would be glad to hear of readers' results, in view of the great variation in local conditions that obtain.

Notes on Operation

To conclude, here are a few words of warning with regard to short-wave work. Keep dust out of the variable condensers, otherwise they will become noisy and make searching a scratchy business. Keep contacts clean; a small amount of dirt makes a big difference at these high frequencies. Keep the set and, above all, the coils dry. In damp weather it may be found necessary to dry the coils out over a fire or stove before the set will work successfully. Always use the same valve, as there is then no need to readjust values of H.T., L.T., grid-bias, etc. Further, any calibration curve you make is more likely to remain constant. Remember that tuning is somewhat critical, and do not be disappointed if you fail to receive KDKA the first time you try.

*The Seven Circuit
Crystal Receiver*

SIR,—After having my set in use for the last two or three weeks, I feel I should write to you, saying how pleased I have been at having made the crystal set illustrated in No. 2 of THE WIRELESS CONSTRUCTOR.

Everything was built at home—the condenser was built, the ebonite drilled, and even the mahogany box dovetailed, glued and French polished.

Being some 23 miles from I.O., and not having an aerial I was obliged to make a coil for Chelmsford. This was done on the honeycomb method, a former was made out of a piece of curtain pole, and 46 nails driven therein. As the nails were different sizes, and burred up the wood of the pole, the coil did not slide off so easily as might have been. With the aid of a reel or two of white cotton it was drawn into some kind of shape.

We tried some wire in the loft, and heard Chelmsford, and also got a very fair reception off the rain gutter, even when the rain was pouring down. However, we possessed a clothes line of that Government insulated steel wire which sagged to within 4 ft. of the ground, so we ran that in through a chink and the reception is loud and clear.

Thinking you might like a suggestion or two, might I say that undoubtedly an article is wanted on indoor aerials—how to put one up in 20 ft. by 5 ft., and so on, so as to secure proper electrical balance or symmetry, or whatever it is called.—Yours faithfully,

J. H. GREVILLE.

Brentwood.

Editorial Note: A series of articles on "Aerials For Awkward Places" is now appearing, and will doubtless fill the need expressed by our correspondent.

SPECIAL NOTICE

Query Department

Owing to the enormous increase in correspondence as a result of the publication of this journal, the above department is temporarily unable to deal with further queries, although every effort is being made to provide :: further facilities and new staff ::

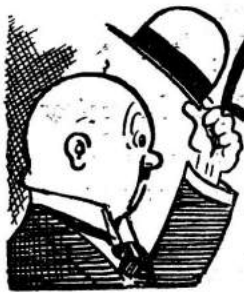

MR GUMPLETHORPE

Gets On

By "BROADCASTER"



WHEN an out-and-out cast iron, dyed in the wool hater of wireless becomes converted he generally turns into the most violent type of radiomaniac in a remarkably short time. What happens, I imagine, is that the germ responsible for radiomania gets tired of biting people who succumb without a struggle to its attacks. "This," it says to itself, "is too easy. I am getting bored by these people who simply put up no show at all, but fall victims at once. Give me something with some kick in it." And then the germ discovers somebody like our friend Mr. Edward Gumblethorpe. With a shout of glee it goes for him tooth and nail. I believe that I am right in saying that germs are actually unprovided with either fangs or talons, still you see what I mean. Its

young Ben was to accompany Horace to the select seminary for young gentlemen when the new term began, he knew that he had not long to wait until the coast should be clear. The great day came at last. Mr. Gumblethorpe took the lads to London, conveyed them across in a taxi, and saw them off on the last stage of their journey. Cruel though it must sound, I must confess that even though there were now two pairs of eyes streaming with tears above four cheeks bulging with toffee drops, Mr. Gumblethorpe was far from sad. In fact, when the train began to pull out of the station he stopped waving his handkerchief as soon as he decently could, and positively danced off the platform whistling "It Ain't Gonna Rain No Mo'."

hear you say I beg your pardon? Granted as soon as asked. Let us now proceed without further ado. Mr. Gumblethorpe was not such a fool as to think of beginning with an umpteen valve Super Heterodyne. He had quite made up his mind to begin at the beginning. For this reason his mind ran entirely upon catwhiskers and crystal cups, and things of that kind. He had resolved that later on he would read "From Valve to Crystal, or Out of the Frying Pan into the Fire," by Mr. Headbath, but for the moment his foot was set upon the lowest rung of the ladder, and he was determined to climb slowly and surely. So many fellows dash at the ladder bald headed, only to find that there are two or three rungs missing which they do not see; they come to understand

Where he Went

Hailing a taxi he was whirled off, still whistling, to a wireless shop. Mr. Gumblethorpe passed the day in a perfect orgy of wireless. He invested first of all in vast quantities of literature—"Twelve Messed Up Wireless Sets," by Mr. Hercy Parris; "Tuning Coils But Never Mind Them," by G. P. Bendall; "Wireless Sets as Home Destructors," by Mr. E. Headbath; and "Ten Thousand Wireless Answers Questioned," by Messrs. Bendall and Headbath. These, with "Soldering Simplified, or Wireless Made Greasy," by an author who has had the sense to remain anonymous, completed his literary outfit.

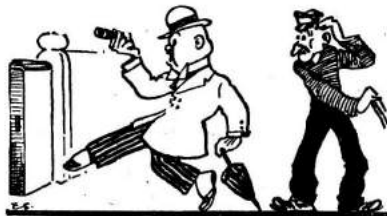

Danced off the platform.

first onslaught is repulsed. It retires with what to a microbe is the equivalent to a thick ear. But he recoils only in order to leap better. Its next onslaught is far more furious, and if it is driven off it goes round and whacks up lots of its little pals to come and help. In the end the fortress is captured, and having effected an entry the germs simply make hay of everything, and the victim has a terrible time of it.

When the Boys went Away

Mr. Gumblethorpe's case followed these lines precisely, and when he caught radiomania he got it, in the words of Shakespeare, where Anne Boleyn got the axe.

Somehow he felt that he must curb his wild desires so long as the boys were at home, but since

Mr. Gumblethorpe was not the kind of man to purchase a ready-made set. No real enthusiast does this. Would you buy your clothes ready made? No, a thousand times no. Then why purchase a reach-me-down receiving set? It may be objected that if any enthusiastic amateur of the sterner sex endeavoured to make his own clothes the results might be rather painful, and therefore the analogy is not a good one. Anyhow, I have seen a good many home-made wireless sets that were pretty queer misfits. But I digress, though the fault is yours, not mine. Did I



Flattened his nose against the window.

what Mr. Jorrock's meant when he said, "A fall's a awful thing."

Somebody's Fall

I once knew a man who sent in to the test department a seventeen-valve super-purodyne, remarking, brightly, in his covering letter that it was his first attempt at wireless construction. He added that there must be some little thing wrong with it because it would not work. There was not very much amiss. He had merely placed the high-tension battery condenser in series with the L.T.—lead, tuned his anodes with rheostats instead of variable condensers, provided for the regulation of filament voltage by means of variable condensers, connected the grids of his valves to the O.P. side of the transformers

CHARGE YOUR OWN ACCUMULATORS FREE

The New ULINKIN
PAT. NO. 2,239
12/6

D.C. Home Battery Charger is only

Whilst still recommending the "Standard" model ULINKIN as the most reliable Direct Current Home Battery Charger on the market, we have now introduced the

ULINKIN JUNIOR

in response to numerous requests for a more inexpensive model within the confines of the modest purse.

The "ULINKIN JUNIOR" is a complete and guaranteed efficient Home Battery Charger and enables those who have a DIRECT current supply of electricity in their homes to recharge their own wireless accumulators at home absolutely free of cost. It is supplied complete with wiring diagram, explicit and simple instructions for fixing, cable for connecting, and porcelain connectors—all for the ridiculously low price of 12/6 post free.

The famous "ULINKIN" STANDARD model is fitted with an ammeter reading from 0 to 10 for registering the charging current. The price of this handsome instrument, complete with instructions and all fittings, is 42/- carriage free.

Cut out ALL the trouble and expense of accumulator charging by sending your order NOW, or write for illustrated booklet, post free.

Trade enquiries invited.

THE GRAN-GOLDMAN SERVICE CO.

(Dept. C.8),
 71, FLEET STREET,
 LONDON, E.C.4

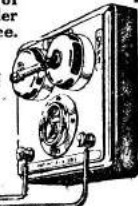

L.F. TRANSFORMER

(Patents Pending)

Constructed with one primary winding with a secondary winding on either side—therefore, minimum self-capacity with greater amplification which remains constant over a wide band of frequencies.

"On test, the insulation proved excellent music and speech revealed remarkable freedom from distortion, whilst, in comparison, this transformer came out with flying colours."

—Wireless Weekly, 24 Dec., 1924.

No. 5150 High Ratio for first stage
 No. 5151 Low Ratio for second stage

27/6

From all good Wireless Dealers

IMMEDIATE DELIVERY

C.A.V. Vandervell & Co. Ltd.

WARPLE WAY ACTON, LONDON W.3

Telephone: Chiswick 2000 (7 lines).



Our Guarantee.

By reason of the high standard of efficiency of the Famous Formo Components, the rigorous methods employed in our test department, and the equally stringent choice of raw materials, enabled us to be the first manufacturers to back our products by an unconditional guarantee.

The reflection of our confidence in the Famous Formo Components is epitomised in this our guarantee: that these are guaranteed unconditionally to perform satisfactorily, to be highly efficient and to give results unexcelled.

Formo Company



THE FORMO COMPANY

ARTHUR PREE & Co., Ltd.
 Contractors to the Admiralty, War Office, India Office, Air Ministry, and Post Office.

Chief Office and Works:
 CROWN WORKS, CRICKLEWOOD LANE, N.W.2.

Resident Representatives:
 Scotland: Mr. Miller, 22, York Place, Edinburgh.
 Manchester: Mr. J. B. Levee, 23, Hartley Street, Levenshulme.
 Birmingham: Mr. H. E. Cruicker, 134, Reservoir Road, Erdington.

I personally guarantee

the consistent efficiency and reliability of the Famous Formo Components. The Home Constructor rightly expects that his home constructed receiver should yield results which shall be the envy of his friends. These envied results, however, are often an adventure—made the more speculative by the employment of such apparatus as is neither used nor recommended by technical authorities. The Famous Formo Components—The Famous L.F. Transformer and Formo Variable Condensers, for example—designed with fearless originality to give unexcelled results. Experimenters who build the Famous Formo Components into their sets—incorporate gilt-edged securities with the assurance that they will yield the good dividend of highest efficiency.

ARTHUR PREE, A.M.I.E.E.

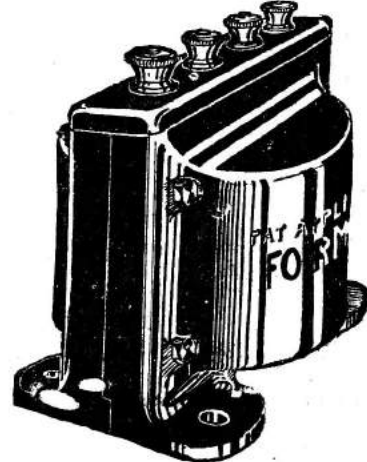

Barelays 900



After 25 years'

close acquaintance with the needs of engineers we are naturally familiar with every phase of prevailing conditions.

In keeping pace with the latest advancements we have forged a link of confidence between the Home Constructor and ourselves.

To those who appreciate the dependable values offered by a house with a reputation to maintain we say "SPECIFY 'ORMOND' PRODUCTS—ALWAYS."

We specialise in turning Brass and Steel Screws and Machined Parts and Accessories of all descriptions.

All Cheques and Postal Orders should be crossed and made payable to the "ORMOND ENGINEERING CO."

Write for our New (1925) Catalogue.

TRADE TERMS ON REQUEST.

**ORMOND
ENGINEERING CO.**
199-205, Pentonville Road,
King's Cross, London, N.1

*Telegrams: "ORMONDENGI, KINCROSS."
Telephone: CLERKENWELL 9344 (3 lines)*

FACTORY:
WHISKIN STREET, CLERKENWELL.

Look for the name "ORMOND"
on our Products!

Neutrodyne Micro-Condenser

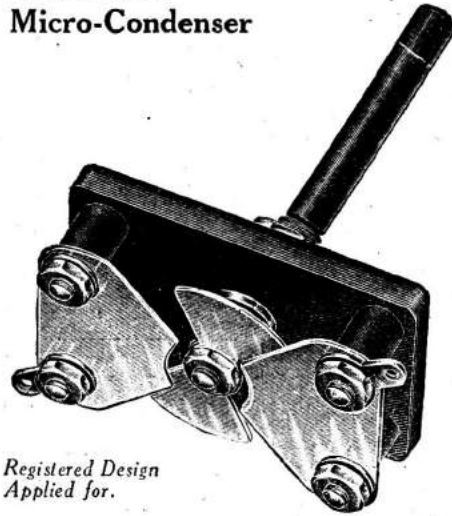

*Registered Design
Applied for.*

A useful adjustable condenser of small capacity and dimensions, soundly constructed, essentially designed for providing feed back and oscillation neutralizing potentials. One hole fixing.

Fitted with Terminals and Soldering Tags.

Price 2/- each

Short Wave Air-Dielectric Fixed Condensers

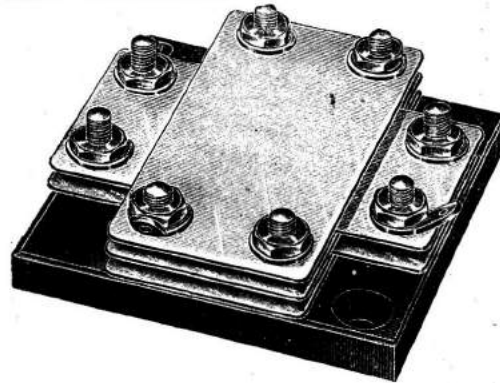

For sharp tuning and to shorten the wave-length, thus facilitating self-oscillation by the reduction of capacity in the aerial circuit, a small fixed capacity series condenser having an air dielectric must be used.

Nominal Capacities: .000025, .000035, .00005.

Price 1/6 each

*ALSO MADE IN LARGER CAPACITIES
FOR CONSTANT AERIAL TUNING.*

25 Years' British Manufacturing Experience

and the plates to the gridleaks, forgotten all about an aerial-tuning inductance, and connected the telephones across the positive and negative terminals of the accumulator. That was all, but these little things just sufficed to make all the difference between perfect efficiency and comparatively poor results. You see what I mean? Again, dear reader, I digress, but we will hark back once more to our theme. Anyhow, you cannot complain that I am not giving you some exceedingly sound advice. What I mean is this. I knew a man once— [Yes, yes, but will you please get on with Mr. Gumplethorpe's adventures?—ED. Oh, very well; but are you not rather hasty? I knew a man once— That will do. Get ON.—ED.] That is the sort of conversation, reader, that takes the heart out of a man. I go and give the Editor a leg-up by bringing in a mention of his "Twelve Messed Up Wireless

strain put upon it by the descent of a twenty-seven stone passenger into the vacant place having buckled its spindle into a plausible imitation of the backbone of a dyspeptic eel, Mr. Gumplethorpe presented it to the conductor, with a little courtly bow and an expression of the hope that he would find it useful. He did a little later, when a barking dog followed the bus. There were also coils, and wires and crystals, and whiskers and fixed condensers, and earth pins, and spreaders, and pulleys, and guide ropes, and other odd bits and pieces in abundance. "If," said Mr. Gumplethorpe, to himself, "the thing is worth doing at all, it is worth doing thoroughly."

His First Set

Mr. Gumplethorpe proceeded after dinner that evening to assemble his first crystal set. He was a little handicapped by his inability to follow the cryptic symbols of wiring diagrams. Who could blame the man if he mistook a series of in-and-out curves for the representation of the catswhisker, and the thing looking like an arrow piercing two beef steaks at one blow for the crystal cup? The circuit which he evolved that night was certainly original, though it looked more like a barbed-wire entanglement after being shelled by 5.9's than anything else. Luckily for Mr. Gumplethorpe, he possessed an expert friend, to whose home he repaired, notwithstanding the lateness of the hour, in order to get all the advice he could for nothing. What he said can only be expressed by dashes, asterisks, daggers and things of that sort, for when a man lets himself go to a bosom friend on the subject of his first attempt at a wireless set, what he says is not to be printed in the more usual alphabetical symbols. The friend calmed him down and assured him that all beginners suffered some tribulations and promised to come round on the following evening to set matters right.

He duly turned up, saying, as he entered, "Good evening, Gumplethorpe. I have come round to put that crystal set of yours right." "Crystal set!" cried Mr. Gumplethorpe, "crystal set! Oh, that was yesterday. I have given up crystals now and I am just making my first single-valver."

Troubles

And that, dear reader, is a true and faithful account of the first two days in which Mr. Gumple-

thorpe let himself go as a wireless man. On the third he came down to earth, renouncing the valve in favour of the crystal. On the fourth, when dawn was gilding the skies, he flung all his components into the dustbin, rescuing them carefully after breakfast when he had had time to think matters over. On the fifth, whilst he was trying to think of some plausible reason for summoning Ben and Horace back from school to help, he suddenly stumbled upon something that would work. He had undoubtedly got 2LO, but there was something lacking about the strength. It must be the coil. Mr. Gumplethorpe wound two more, but whilst he was out of the room for a moment in order to find some string with which to secure their ends, the kitten got at them. Undeterred, he telephoned to the nearest wireless shop for a dozen. Experiment showed him that it was not the coil. In that case it must be the con-

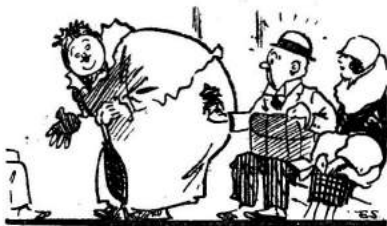

Spoiled by a twenty-seven stone passenger.

Sets," and that kind of thing is all the return I get. It is a hard life, this writing business. I knew—I don't care whether you knew six men. What we want to hear about is Mr. Gumplethorpe's adventures. For the last time, GET ON.—ED.]

All right! Editors are—but, no, I will refrain. Mr. Edward Gumplethorpe spent a very large part of the day in flattening his rather retroussé nose against the windows of dozens of wireless shops. Several of them he entered. He asked questions much worse than those usually put forward by the beginner. Scores of wireless salesmen went mad and were removed to Colney Hatch on that terrible day.

Disaster

He reached home at length, having pawned his watch in order to pay his bus fare since all his money had been expended, with seven pairs of telephones and six variable condensers. These also were seven when he started on his journey, but one of them he left upon the seat beside him, and the



Flung them into the dustbin.

denser. He tried all that he possessed, and several of which he became subsequently possessed, though he could not afford them. It was not the condenser. It must be the catswhisker. He tried thin ones and curly ones, and blunt ones and pointed ones, and brass ones and copper ones, and gold ones and tin ones. It was not the catswhisker. It must be the crystal. He tried Blowmetite and Blatherskite, and Dynamite and Gelnigite, and coke. It was not the crystal. He suspected the earth plate. He dug it up. He purchased a new one of enormous size and buried it practically in the bowels of the earth. It was not the earth plate; but it was, though Mr. Gumplethorpe did not discover the fact for some little time, that he had forgotten to connect it to the appropriate terminal of his set.

And there we must leave Mr. Gumplethorpe still struggling to obtain perfection with his crystal set. He has since taken to valves and of his tussles with them I shall have more to tell you next time.

Take Care of Your Telephones !

By **STANLEY G. RATTEE, M.I.R.E.,**
Staff Editor

An article of interest to all who listen



PROBABLY the most sensitive accessory of any wireless set, exclusive of valves, is the telephone headpiece, yet in many cases this is the most abused. In fact, it may be said that many listeners upon purchasing a pair of telephones do much to affect the sensitiveness of these instruments right from the very commencement by the common practice of removing the earcaps in order that they may see "how they work."

Firstly, it is quite conceivable that the unscrewing of the ebonite earcap by inexperienced hands may bend the thin diaphragm which it holds in position; secondly, the correct position of the earcap may not be found when the latter is replaced; and thirdly, the washer which is usually inside the earcap may not be put back in the right place.

Connecting to the Receiver

Perhaps one of the most common faults made by listeners is the manner in which they connect their telephones to the receiver. In common with several other small details in radio there is a right and a wrong way of connecting telephones, the right way resulting in increased efficiency, with long life, and the wrong way terminating in the spoiling of the instruments. In view of these remarks, it is rather remarkable that manufacturers of telephones do not in every case draw the purchaser's attention to this fact.

Important Features

The most important features in any telephone receiver are the magnets, the coil windings and the diaphragm, and, assuming that we do not probe the diaphragm with a pencil or that the coils do not get burnt out, there remains only one factor to be considered in regard to the useful life of the instrument, namely, the permanent magnet.

Makers of telephones have devoted considerable research work to the finding of a suitable steel with which to make telephone magnets, and it may be understood that every good make of telephone is built with a magnet which has undergone a very exhaustive test, embracing chemical, mechanical and magnetic qualities.

In view of this careful selection on the part of manufacturers, it behoves the users of telephones to refrain from neutralising the good work, if it is their ambition to get the best results.

The Permanent Magnets

The permanent magnets contained within a pair of telephones are as a rule in the form of a ring,

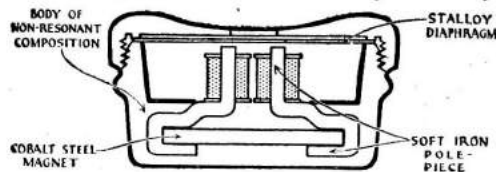

Showing the interior construction of a telephone earpiece.

or else built up from ring laminations, and carry soft iron pole pieces on which the coils are wound. When assembling the telephones extreme care is taken to ensure that the coils are so connected that when a current flows through the receiver in the correct direction the magnetism of the permanent magnet is reinforced.

The diaphragm of the telephone is always under the "pull" of the magnet, and has therefore a tendency to sag in the direction of the pull; now, when this pull is increased or relaxed, the diaphragm is attracted or released accordingly.

Assuming now that the telephones are connected the right way on a receiver, the flow of current produced by the received signal will assist the "permanent pull"

and we shall be getting the maximum effect from the diaphragm in that operating under these most favourable conditions it will respond to most feeble currents flowing through the coils. If the telephones were connected the wrong way round, then, in the case of a valve set where the telephones are in the anode circuit, the "permanent pull" would be weakened and current changes in the coil windings resulting from received signals would still further reduce it, lowering, therefore, the general efficiency.

Reduction in Magnetism

Were this the only disadvantage, then a wrong connection would merely affect results, and not the instruments, but, unfortunately, if the telephones are left wrongly connected in a valve set for a sufficiently long time, the opposing currents will gradually reduce the strength of the magnets, and the telephones will be ruined.

In the good makes of telephones provision is made for this possible condition of things by marking the earpieces positive and negative, and also by binding in red one of the two ends of the telephone leads which is connected to the set. When connecting headphones to a valve receiver, every care should be made to see that the positive of the phones is connected to the positive phone terminal of the set, whilst in the case of a crystal set the connections should be tried both ways, choosing very weak signals with which to make the tests.

A Simple Test

It may be found that with some makes of telephones that their polarity is not indicated, in which case the following simple test may be made. Take a silver coin and another of copper and place them

Duodyne

A Genuine Long Range
LOUD SPEAKER RECEIVER

Guaranteed Range under average conditions:

DUODYNE III	Headphones	...	3/4,000 miles.
DUODYNE V	Headphones	...	4/5,000 miles.
	Loud-Speaker	...	1/1,200 miles.



A child can tune it!

Music all round the dial.



CONSTANT - TUNED H.F. AMPLIFIER

Automatic Tuning—No Condenser required.
The Heart of the Duodyne Receivers

The Curtis "Constant-Tuned" High-Frequency Amplifier is the only automatic high-frequency amplifier which, when connected in circuit, guarantees high efficiency for two stages or more of radio amplification on any wavelengths between 300 and 3,000 metres, and requires no additional controls, **NOR MORE EFFORT, SKILL OR PATIENCE IN TUNING, THAN IS REQUIRED FOR THE OPERATION OF THE USUAL ORTHODOX SINGLE-STAGE TUNED-ANODE CIRCUIT.**



Circuit diagrams supplied
free with every amplifier.

Type A, 300 to 800 metres.	Price 15/-
Type B, 800 to 3,000 metres.	Price 17/6

Postage 6d.

BUILD YOUR OWN DUODYNE

The wholly inexperienced can build this long range receiver with the aid of The Curtis-Duodyne envelope for home constructors containing:—

1. Circuit diagrams for 3 and 5 valves.
 2. Simplified Lay-out and Wiring Charts for 3 and 5 valves.
 3. Instructions for Operation.
 4. Complete schedule of all material required.
- SOLD EVERYWHERE.**

1/6

CUT OUT YOUR LOCAL STATION.

Used in conjunction with an efficient High-Frequency Receiver the Curtis Ejector enables any British Broadcasting Station to be tuned in at will while operating 1½ miles from local principal station or even nearer from relay station. **35/-** Practically eliminates Morse and Mash, and assures pleasing reproduction.

"Nightly I Tour the Continent."

"... With an indoor aerial on my Duodyne III I receive all B.B.C., most Continental, and four American stations nightly, whether London is on or not... Tuning is absurdly simple, as there is 'music all round the dial'..."

Golders Green, N.W.

"The set goes very well indeed... I may say we got Havana, Cuba, the other morning, which none of the sets in this town have got yet."

C. J. H., Thurso.

"I must say I am delighted with mine. Nightly I tour the Continent."

Bush, Bradford.

"You will be interested to know that I received WGY Schenectady on a loud speaker almost as loud as 2LO on my Duodyne V at Croydon..."

J. A. Fowler, M.I. Mech. E.,
Wellman Smith Owen Engineering Corporation, Ltd., Kingsway, W.C.2.

TWO STAGES OF H.F. AUTOMATIC TUNING

The extraordinary range and simplicity of operation, exclusive to the DUODYNE RECEIVERS, must make an irresistible appeal in Imperial and Continental markets.

THE DUODYNE Long-Range Receivers will discriminate between Radiola Paris and 5XX Chelmsford, or, used in conjunction with a CURTIS EJECTOR, will tune in any Broadcasting Station at will, while operating 1½ miles from local Station or 200 yards from Relay Station.

The DUODYNE CABINET.—The Duodyne V is also supplied in French Polished Oak Cabinet with folding doors, enclosed valves and tuning coils. Self-contained batteries. Instrument only **£27**

The DUODYNE III. (Instrument only) Panel Type **£10 0 0**

The DUODYNE V. (Instrument only) Panel Type **£18 18 0**

The DUODYNE PORTABLE IV.—Loud-speaker from anywhere in the United Kingdom on Frame. Shortly available **£30 0 0**

Sales Organisation:

PETER CURTIS, LTD.

IN CONJUNCTION WITH

THE PARAGON RUBBER MFG. CO., LTD., HULL
75, CAMDEN ROAD, N.W.1.

Telegrams: "PARACURTEX." Phone: NORTH 3112.

BIRMINGHAM: 75, Newhall Street. Central 7236.
MANCHESTER: 312, Deansgate. Central 5095.



ECONOMY —real and false

Wuncell exclusive advantages featured:

No. 1

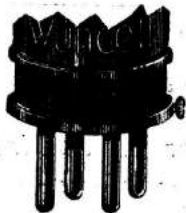

THE man with a multi-valve Set using bright emitters can replace his valves one by one as they become useless by Wuncells W.R.1 and W.R.2. These are the only dull emitters on the market that can be used with a 2-volt, 4-volt or 6-volt accumulator without any alteration to the Set.

Every W.R. type of Wuncell has incorporated in its base a special resistance which can be short-circuited when not required by the screw shown above. When all the bright valves have been replaced by Wuncells these resistances can be short-circuited and the accumulator altered to give 2 volts with a greatly increased capacity. Full instructions for this simple alteration are supplied with every Wuncell valve:



Prices:
W.1 For Detector or L.F. Amplifier
W.2 (With red top) for long distance reception
 18/- each



* **W.R.1** Corresponding to W.1
 * **W.R.2** Corresponding to W.2
 20/- each
 * Fitted with internal resistance as above.

THE point is just this: Can you afford *not* to use Wuncell Dull Emitters.

Or, let us put it in another way. You own, perhaps, a 3-valve Set. Now the average bright emitter valve consumes about .7 of an ampere every hour. Three of them, therefore, will consume 2.1 amps. every hour you are using them. If your accumulator is rated at 6 volts 30 amp. hours (that is a good average size) you will get about 15 hours' use from it on a charge.

The cost for this may be anything up to 2/-. Eight shillings for a month's broadcasting—practically £5 per year. Not much when compared with the pleasure you obtain, but still quite an appreciable item in the family exchequer.

* * * * *

Now let us see what you would be paying if you used Wuncells. First of all you would re-connect your accumulator to give 2 volts only by connecting all the cells in parallel instead of series. This will triple its capacity and give you 2 volts 90 amp. hours, but the charging cost won't be any higher.

Wuncell Valves function best at 1.8 volts and consume .3 of an amp. per hour—your 3-valve Set, therefore, will consume .9 amp. per hour, and your accumulator will last six weeks on one charge.

In other words, you get 5 weeks' broadcasting for nothing every time you get your accumulator charged if you are using Wuncells. And they will save their cost in a couple of months or so.

* * * * *

That is not all. The filament of a bright valve is naturally incandescent. It glows at a white heat and becomes brittle. No matter how careful you are, sooner or later the filament breaks and your valve is useless . . .

But see the Wuncell working. You'll have to look pretty hard before you will realise that the filament is glowing. In daylight it is almost invisible. In fact, it is the nearest approach to the cold valve yet produced.

Isn't it obvious that such a low temperature must mean an exceptionally long life? And to make the Wuncell even stronger, we have inserted a centre support to the filament. No wonder *Amateur Wireless* reported that its filament "is practically unbreakable."

* * * * *

So you'll readily admit that not only do you save quite a considerable amount in running costs, but you get a valve that is likely to last at least three times as long as the ordinary bright emitter. Surely this is real economy.

Cossor Wuncell Valves

THE ONLY DULL-EMITTER VALVES SOLD IN SEALED BOXES

Advertisement of A. C. Cossor Ltd., Highbury Grove, N.5

Gilbert Ad. 2294.

side by side with their edges touching, and drop a spot of vinegar where the two join. With this done, place the phones upon the head and touch the coins, one with each end of the phone lead. By doing this a faint click will be heard, upon which reverse the leads and touch the coins again; do this several times until one is able to decide which way gives the loudest result, whereupon that lead which is touching the silver coin is that which should be connected to the positive terminal of the set. It may suggest itself to the reader at this point that this test may be made with a small dry battery, but since the click would be so loud with either connection, the use of such a battery for this purpose is not advocated.

Connecting Phones to a Valve Set

When connecting the telephones to a valve receiver, they should be connected as already stated, positive to positive, and in those cases where readers do not know which of the telephone terminals of the set is the positive, one of the telephone tags should be connected to the J.T. positive and the telephone terminals touched each in turn with the remaining telephone tag; that terminal which gives the loudest click is the positive terminal.

Don't Drop Them!

Apart from wrongly connecting their telephones, many listeners damage these sensitive accessories by dropping or jarring them and, which is equally bad, allowing the two phones to bang together when removing them from the head. There is perhaps nothing which reduces the efficiency of a pair of telephones so much as the careless banging about which some instruments are called upon to endure.

Faulty Cords

Exclusive of loss of efficiency in the true sense of the word, it sometimes happens that telephones either fail to work at all, or else give intermittent results. In many cases such a condition of things may be easily remedied, for the symptoms usually indicate a faulty

at fault, and we must look elsewhere for the trouble.

The next procedure in the event of the battery test failing to give results is to replace the telephone leads with one of home-made manufacture and try once more, when, if there are still no clicks, then the fault is in one of the ear

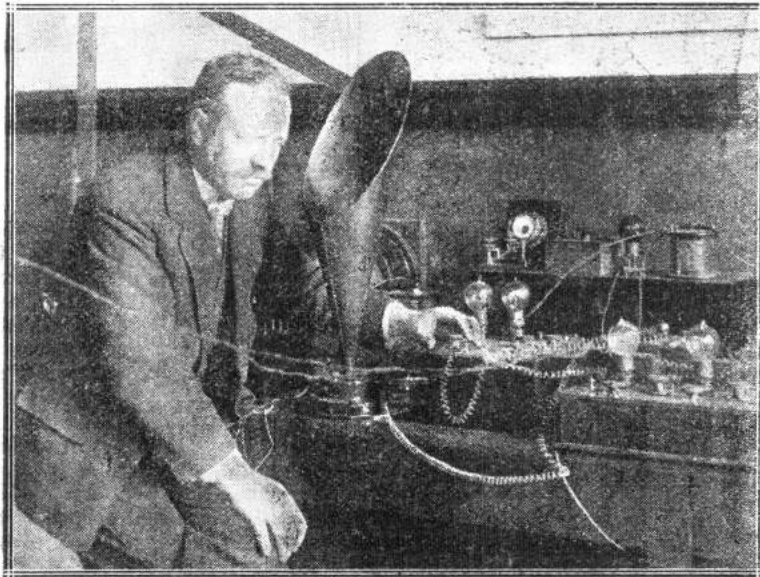

Some of the Wireless apparatus at Scotland Yard, where Major Vitty, seen above, is in charge of the Wireless Department.

telephone cord, and the following simple test should be tried. Place the tags of the telephones across the terminals of a small dry cell, and note whether or not a loud click is heard at the time of contact and disconnection; if this results in nothing audible then it may be assumed that it is necessary to carry the test one stage further; if, on the other hand, a loud click results, then the phones are not

pieces, or both. To test these it is necessary to short-circuit one of them and to again try the battery test; if no sound is heard, then the short-circuiting wire should be transferred to the other phone, and the test again made. Should there still be no sound, then one may find consolation in the knowledge that both phones are at fault and must be returned to the makers for repair, or else a new pair must be purchased.



With Mallet Aforethought!

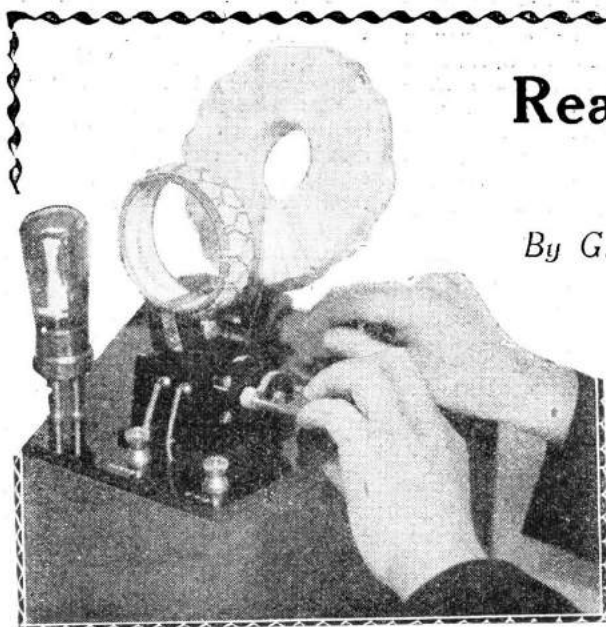

Don't use too large a reaction coil!

REACTION—what a world of hard feelings that word does conjure up in the minds of all who have had just a few weeks of experience of wireless, and who have known what it is to suffer in our own "use" of reaction by the "abuse" of it by others!

A Paradox

It seems strange that one of the most valuable properties of the wireless valve, namely, its power to produce reaction effects, should at the present time constitute a most grave menace to the success of broadcasting and the amateur constructors' movement. I use the words "grave menace" advisedly, because to any reflecting person the outlook is most alarming when it is remembered that in the past six months the evil practice of "reception by oscillation" has increased enormously and there appears to be no reason why a similar increase should not take place in the next six months. The state of affairs is already so bad that in many districts the reception of the more distant stations, especially the Continental ones, is becoming almost impossible at certain hours, as is the case in my own locality. Here one can receive Madrid at very full loud-speaker strength with a four-valve set so long as London is working, using a wavetraps to eliminate interference by the local station, but as soon as $\Sigma I, O$ closes down it seems that all the local oscillators swing up their reaction coils and proceed to search for Madrid, and all that one can hear from that moment is a chorus for thousands of voices of

Reaction: Its Use and Abuse

By G. P. KENDALL, B.Sc., Staff Editor

Some practical notes on a subject of vital importance to all users of the Aether

the howl or squeal variety, and in the midst of it very faint and much distorted telephony. It is no exaggeration to say that in my

case, so long as $\Sigma I, O$ is not working, it is well-nigh impossible to receive any of the more distant stations, because they are simply buried in an overwhelming volume of local "carrier waves."

The trouble is not mainly due, I believe, to people who make a practice of searching for distant stations with their receiving set oscillating and stopping it from doing so when they actually pick up a station, but, rather, the result of the use of receiving sets continuously in an oscillating condition, the operator's idea of tuning in a station being merely to set his receiver to the silent point of the carrier wave and listen to the much-distorted and burbling results so obtained. Now, people who adopt this method of reception can never obtain proper results, since it is practically inevitable that the telephony they hear will be badly distorted and quite unfit to be

described as music. It would therefore seem that what is required is not denunciation, but, rather, education in the proper use of reaction.

Let us, first, see what is meant by the correct use of reaction and clearly understand the object at which we are aiming when manipulating the reaction coil.

Purpose of Reaction

The principal object in using reaction is, of course, to increase signal strength, and this is brought about by the fact that the use of a reaction coil enables us to feed back energy from the plate circuit of one of the valves into the aerial circuit, or, at any rate, into the grid circuit of a valve, to increase the strength of the incoming oscillations. A further great benefit conferred by the proper use of reaction is a very considerable increase in sharpness of tuning or selectivity, so that interference is reduced. Exactly how all this happens does not concern us here, since I do not wish to deal with the theory of the question, but purely with the actual practice concerned in getting good results without making oneself a public nuisance.

It would seem at first sight as though there were no limit to the increase in signal strength which could be produced by means of reaction, but in actual practice this is not so, for if one feeds back more than a certain amount of energy into the aerial one reaches

a condition at which the set breaks into self-oscillation, and beyond that point it is of no advantage to go. On the contrary, as soon as the set begins to oscillate, any telephony which is being

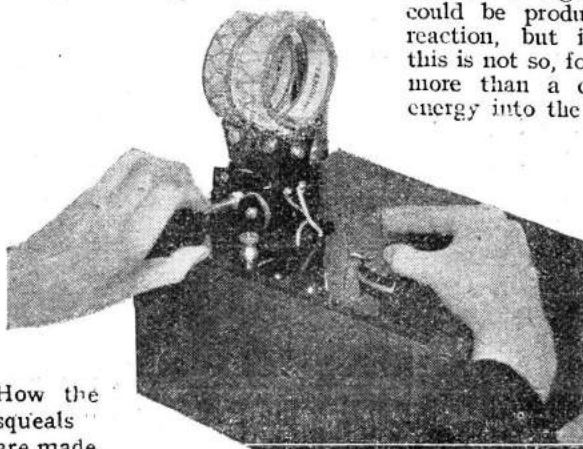

How the "squeals" are made.

Persuading distant Stations to come in

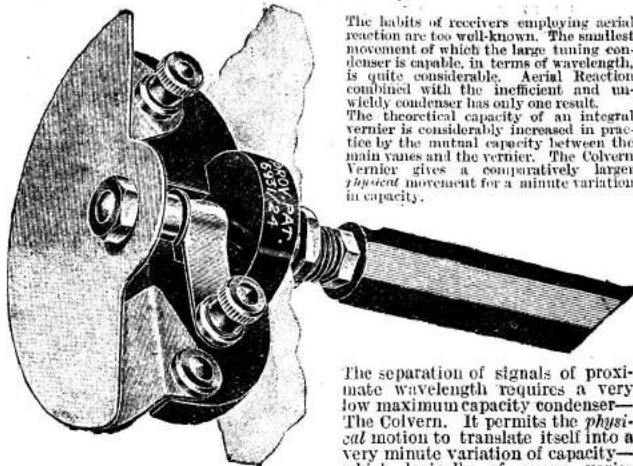

The habits of receivers employing aerial reaction are too well-known. The smallest movement of which the large tuning condenser is capable, in terms of wavelength, is quite considerable. Aerial Reaction combined with the inefficient and unwieldy condenser has only one result. The theoretical capacity of an integral vernier is considerably increased in practice by the mutual capacity between the main vanes and the vernier. The Colvern Vernier gives a comparatively larger physical movement for a minute variation in capacity.

The separation of signals of proximate wavelength requires a very low maximum capacity condenser—The Colvern. It permits the physical motion to translate itself into a very minute variation of capacity—which logically of course varies slowly the wavelength to which the receiver is tuned.

Price 2/6

Really accurate and delicate tuning is within the reach of every experimenter. It may be obtained *not* by using a large unwieldy tuning condenser, nor by employing a vernier integral with the main condenser, but by incorporating The Colvern General Purpose Vernier. This very low maximum Independent Vernier will persuade the utmost range, selectivity and power from your receiver. The Colvern will demonstrate that your set is more sensitive to perfect balance than you have yet experienced. Circuits may be tuned dead accurate to the incoming frequency. **Get one from your dealer to-day.**

When ordering direct kindly give name and address of your dealer.

COLLINSON'S PRECISION SCREW CO., LTD.,
Macdonald Rd., Walthamstow, London, E.17 Tel.: Wal. 532

Barclays 819

"If you're using 7/22's you're sitting in the back row of the gallery. The 'Mars' will put you on the front row of the stalls—"

This heading makes no appeal to the technically-minded, but it graphically suggests the difference in efficiency between 7/22's aerial wire and "Mars" aerial wire which supersedes 7/22's.

If your crystal set's volume gives you the impression that you're on the back row of the gallery, don't blame the set—take down your present aerial and fix a "Mars." The increase in strength and clarity will put you on the front row of the stalls. You will be able to hear every word—every whispered aside. You will be able to hear every note—even when the bars are marked pianissimo.

This announcement is not technical, but it is by no means wholly imaginary.

live. 40,000 "Mars" enthusiasts have proved the claims implied by the comparison we have made.

You can buy 7/22's at "gallery" prices—two shillings or so for a hundred feet, but 9/6, the price of the "Mars," gives you a seat in the stalls of wireless for the long life of this durable super cable.

The "Mars" consists of 84 strands—not 7. Each strand in the "Mars" cable is spirally wound and thus air-insulated—an exclusive "Mars" characteristic. The "Mars" has 80% greater surface area than 7/22's and gives 50% greater efficiency.

Obtainable from most wireless dealers. If you have any difficulty in obtaining, send P.O. for 9/6 to:

E. & W. G. Makinson, Ltd.
Wellington Works
Wellfield Road
Preston

Telephone: 122 "Preston."
Telegrams: "Gold, Preston."
QMA 37



THE MARS AERIAL

As used in the Choke Amplifier Unit described in the current issue by John W. Barber.



Price - 10/6



BEARD & FITCH, LTD.,
34, AYLESBURY STREET, LONDON, E.C.1
Telephone: Clerkenwell 8941

North of England Branch—1 Dean St., Piccadilly, Manchester
Telephone: Central 8240

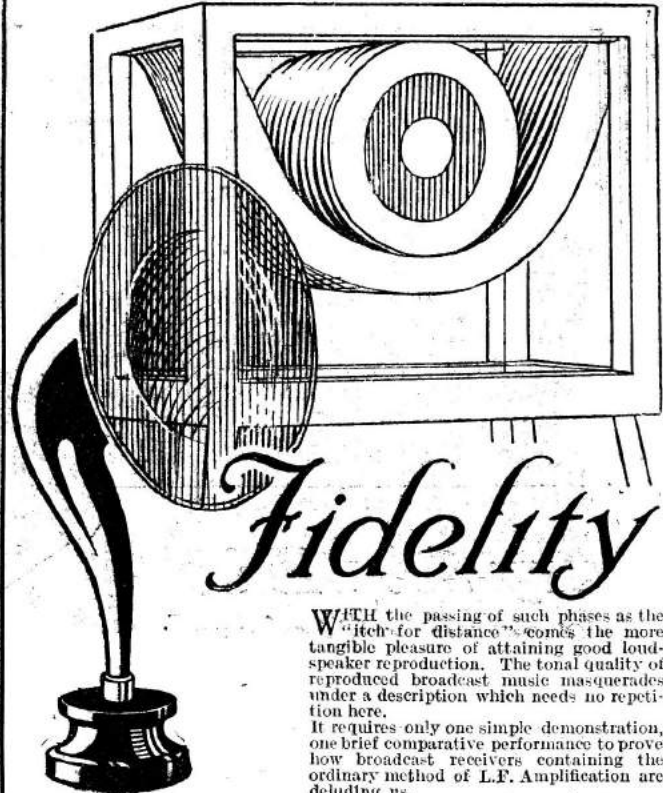

Fidelity

WITH the passing of such phases as the "itch for distance" comes the more tangible pleasure of attaining good loud-speaker reproduction. The tonal quality of reproduced broadcast music masquerades under a description which needs no repetition here.

It requires only one simple demonstration, one brief comparative performance to prove how broadcast receivers containing the ordinary method of L.F. Amplification are deluding us.

The ideal method of intervalve coupling for audio frequency work is choke amplification. Its demand upon the H.T. Battery is considerably less than that in the method employing resistance capacity. With the provision of the scientifically and accurately designed Success Choke it would be interesting to conduct lengthy experiment to prove if resistance capacity would give greater purity.

There is no secret in the performance of the Success Choke. That music and speech are faithfully reproduced, that there is an absolute dead silent background, that there is a complete absence of raucous penetrating mush and the curious distorting noises conspicuous in many receivers, comes not by accident.

The scientific facts which have guided the design of the Success Choke and the considered experiment of expert knowledge in conjunction with an intense criticism that it should reproduce with greater fidelity than any component then available indicates to some measure that in the Success Choke you have a remarkable instrument.

We make no claim for its performance beyond that which you yourself can discover. But we do say that until you incorporate the Success Choke for your audio frequency work the tonal quality and purity of your loud-speaker reproduction is only a delusion.

With the Success Choke, artist, orchestra and speaker are brought to your fireside.



The Bowyer-Lowe Square Law Condenser is the only one giving the square law effect with a wavelength range and capacity ratio GREATER than that of an ordinary condenser. Single, double and triple types supplied, with or without vernier.

SINGLE .0003 ..	16/-
DITTO with Vernier ..	19/-
SINGLE .0005 ..	17/-
DITTO with Vernier ..	20/-
DOUBLE .00025 ..	28/-
.0003 ..	29/-

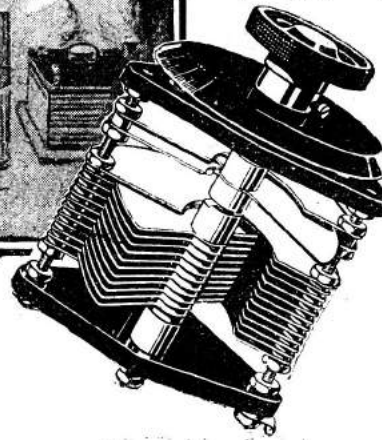

Every Set will be more efficient when "Low Loss" is understood

HAVE you ever wondered why it is that two wireless sets apparently alike in design, layout and wiring may be totally dissimilar in performance? One will yield signals of surprising musical quality over a wide range; the other will in every sense be disappointing.

The "Low Loss" principle affords the answer.

In every receiver, and every component, there are places where a dissipation of electrical energy occurs. Dirty condenser washers will cause this loss of power, so will faulty joints; poor quality ebonite is not a perfect insulator; through it energy is wasted. Thus and thus, in a hundred ways, tiny leakages of power accumulate and in the aggregate seriously affect the quality of the final reception.

These minute leakages are called "Losses."

It has not been sufficiently realised that it is the business of every manufacturer of wireless parts to so design and assemble his products that their construction reduces these losses to a minimum, for "Low Loss" components mean highly responsive sets.

Whenever you have reason to be dissatisfied with the quality of reception afforded by a set you make, be suspicious of losses.

SEND FOR THIS BOOK.
It contains 36 pages of useful information about all Bowyer-Lowe Tested Components, with blank pages for your own notes. It is FREE on application. Enclose 1½d. stamp for postage.

Locate the components which cause them, rebuild your set with parts you can trust, and the tremendous improvement will convert you to the "Low Loss" idea.

But it is better to be sure than sorry. Every single component made by Bowyer-Lowe is a "Low Loss" component, designed by experts and built by engineers in such fashion that its losses are reduced to a minimum.

This fact accounts for the extreme responsiveness of Bowyer-Lowe Square Law Condensers, which give ease of calibration with increased selectivity and wavelength range; it accounts for the high efficiency of every instrument and part we make.

Buy Bowyer-Lowe Parts for all your sets and secure maximum signal quality through low losses.

Bowyer-Lowe Tested Components

Built to secure Low Losses.



MATCHED H.F. TRANSFORMERS.

Every one guaranteed to match perfectly every other in its range. All ranges 150 to 3,000 metres and up, also special Neutrodyne Unit. Price each 7/-



ANTI-CAPACITY VALVE HOLDER.

Through low losses gives greatly increased efficiency, especially on short wavelengths. Fixed without metal nuts and screws. As used by Mr. P. W. Harris. Price 1.2



NEUTRODYNE CONDENSERS.

Minimum capacity practically zero. Low losses make high efficiency in tuning neutralising circuits. One screw fixing with 1/8" hole for spindle. Price 5/-

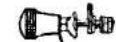

STUD SWITCH PARTS.

Switch Arm, all studs, steps and screws, etc., for making any switch from 2 to 10 way. Drilling template supplied. Price 2.3

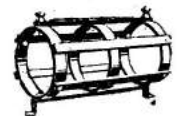

LOW LOSS COIL FORMERS.

For making short wave coils with minimum dielectric losses. Former is 3/8" in diameter, 6 inches long, with terminals and soldering lugs each end and bracket for fixing. Constructed of Grade "A" Ebonite and Lacquered Brass. 5/-



VALVE WINDOWS.

Heavily nickel plated, with rounded bezel, back plate, gauze and all nuts and bolts. A handsome finish to any set. Price each 9d.

ORDER DIRECT OR THROUGH YOUR DEALER.

BOWYER-LOWE CO. LTD. RADIO WORKS LETCHWORTH HERTS.

C.H. FLETCHER AD.

received becomes more or less distorted, any variation in tuning produces howls and whistles from the "heterodyning" of the carrier wave, and one is then radiating.

We shall therefore obtain the loudest signals without distortion if we learn to adjust our set so as to use as much reaction as possible *without* actually producing self-oscillation. This means, in practice, that we must aim at bringing the moving coil as close to the other coil as possible without actually falling over the edge into self-oscillation. This is undoubtedly one of the finer points of operating a receiver, requiring a certain amount of skill and practice; but a beginner is strongly urged to select some fairly strong station which he can pick up easily and to practise upon this the adjustment of his reaction until he can do it with certainty and celerity.

Tuning Variations

It will be found that varying the position of the reaction coil alters to some extent the tuning of the receiver itself, so that when one has brought the reaction coil up nearer to the aerial coil one may have to turn the aerial condenser slightly in one direction or the other, to hear the signals once more at full strength. This is soon learned and the novice should school himself in the habit of turning the reaction coil away from the aerial coil the very instant that he hears the first signs of self-oscillation, endeavouring to visualise, as he does so, the expressions upon the faces of all those of his wireless neighbours who may be suffering from his momentary transgression.

Signs of Self-oscillation

We have been assuming so far that the reader was familiar with the signs of self-oscillation, so that he could make certain of stopping any oscillation which took place very quickly, but a brief explanation should perhaps be given to show how such self-oscillation may be recognised. Upon the majority of sets when the self-oscillation commences, there is a slight click or "pop" in the headphones, after which a faint continuous rustle is heard, which is mostly due to the presence of a continuous stream of small atmospherics, which passed unnoticed when the set was not in the oscillating condition.

Further, if one is actually listening to a telephony station at the time, the speech becomes distorted and is mixed up with howling and whistling noises when the variable condenser is turned. This latter is probably one of the surest signs, and it can be taken as a general rule that if shrieks and howls are heard whose pitch can be varied by turning any of the variable condensers in the set it is a sure sign that the receiver itself is oscillating.

Smooth Adjustment

Having satisfied oneself by experiment that we can recognise the symptoms of self-oscillation with reasonable certainty, we may next proceed to consider how we may make the set as controllable as possible, so that it will not oscillate when we do not intend it to do so. The ideal state of affairs is, in the case of a set

means either that an unsuitable grid leak is being used, that the high-tension supply to the rectifier is too high, or that the filament supply for this valve has been turned down too low. Care must be given to all these points to get the set into the proper easily-adjusted condition, otherwise it will be continually flopping into self-oscillation when one is trying to adjust for a distant station.

The Coil

Having made the correct adjustments upon the valves to produce a fine control of reaction, we may next turn our attention to the question of the reaction coil to be used. Much trouble may result from the use of an unsuitable size of coil, and it would be advisable to try several sizes, since the correct one may vary somewhat with individual conditions. A fairly definite rule can be laid down, however, that the size of the coil should be such as to make the set oscillate when the reaction coil is some little distance from the coil upon which it is reacting, so that the tuning adjustments may not be very much upset by movements of the coil. The actual size of coil which will be required will depend upon the type of receiving set with which it is to be used, particularly as regards the number of high-frequency valves, but in general where only one high-frequency valve is incorporated a number 50 or its equivalent will



The French Ambassador to America has already fallen a victim to the radio fever.

be quite adequate for the broadcast band, while a set employing no high-frequency amplification may perhaps require a No. 75.

employing reaction, that the high and low-tension supply to the valves, the size of reaction coil, &c., are so adjusted that when one brings up the reaction coil the set passes very gradually into self-oscillation, without a very loud click, and further that when one withdraws the reaction coil, self-oscillation shall cease in a similar quiet manner at the same point as that at which it commenced. This desirable state of affairs is usually brought about quite easily by paying careful attention to the adjustment of the detector valve, particularly its high-tension supply. If the set becomes very "floppy," giving a loud pop when it passes into oscillation, and continues to oscillate for some time after the reaction coil has been withdrawn beyond the point at which the oscillation commenced, it probably

perhaps require a No. 75.

Using a Potentiometer

So far we have considered only sets in which reaction coil is used, but it should not be assumed that sets which do not possess such a coil cannot oscillate and cause interference, since this is by no means so. Sets employing two or more high-frequency valves are commonly controlled by means of a potentiometer, a reaction coil being optional. In such sets the adjustment of the potentiometer should be regarded as equivalent to the movement of the reaction coil, and all the precautions which I have already described must be taken, if one wishes to behave as a well-regulated citizen of the aether.

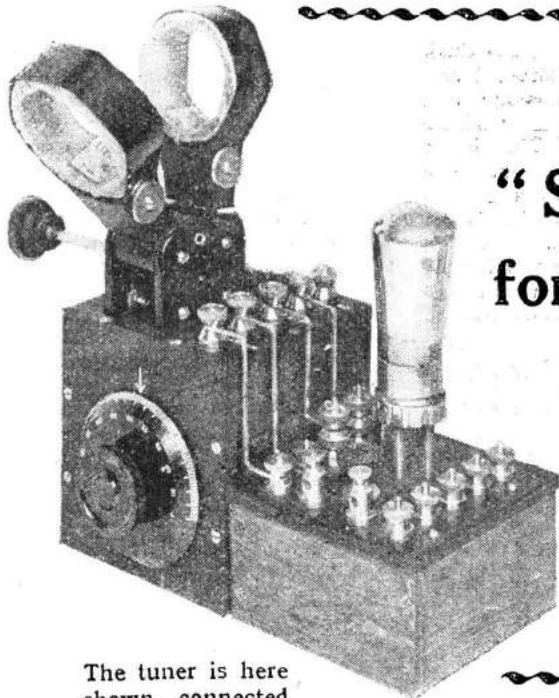

The tuner is here shown connected to the valve panel.

The "Short-Wire" Tuner for all Wavelengths

By A. S. CLARK

A compact and remarkably efficient tuner primarily intended for use in conjunction with the very popular little valve panel which appeared in the January issue

THE tuner about to be described is designed for use with the "Short-Wire Valve Panel" described in the January issue of THE WIRELESS CONSTRUCTOR. As the photograph of the two units joined together shows, the top panel of the tuner is the same size as the valve panel (*i.e.*, 4 in. by 4 in.), and although the depth is 2 in. more, it looks very well as a completed set.

A Complete Unit

It is a complete unit in itself, and therefore can be used in conjunction with any set which needs an external tuner. It will prove very

variable controls is very easy, due to their convenient positions. It is possible by means of the small switch and terminal A_2 to change from parallel to series tuning.

The Components

The tuner will be found simple and cheap to construct, and the components required are given in the following list. Of course, any good components of makes other than those specified may be used with equal results, providing they are of such a size that they may be fitted in. The space is very limited, and therefore this point should be considered before the components are purchased.

One two-way coil holder (Duco Vernier. Brown Bros.).

One .0005 μ F. variable condenser (Jackson Bros. Square-Law).

One miniature single-pole two-way switch.

Five nickel-plated terminals (Burne-Jones).

Two 4 in. by 4 in. by $\frac{1}{2}$ in. ebonite panels (Peter Curtis).

One packet of Radio Press Panel Transfers.

One piece of wood, 4 in. by 12 in. by $\frac{1}{2}$ in.

Length of square wire, 13 wood screws, and two 5 or 6 B.A. 1 in. brass screws.

Construction

The construction is commenced by marking out the two panels in accordance with the drilling diagram in Fig. 2. The two front holes

in the top panel are for joining the two panels together, and they should be clearance holes for the particular screws used. The parts on the top panel may now be fixed in position, and as it is best to join the edges of the two panels while serewed to the containing box, the construction of this will be given next.

The 4 in. by 12 in. piece of wood must be cut into three pieces of the following sizes: 4 in. by 3 $\frac{3}{4}$ in., 4 in. by 3 $\frac{1}{2}$ in., 4 in. by 3 $\frac{1}{2}$ in. These pieces of wood are joined together to form a three-sided containing box with no bottom. The 4 in. by 3 $\frac{1}{2}$ in. piece is to form

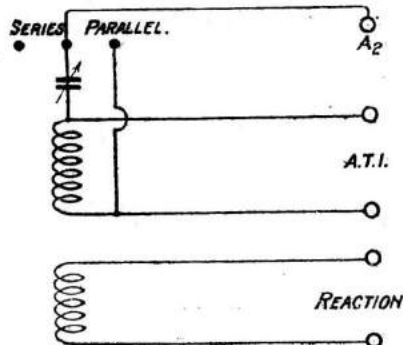
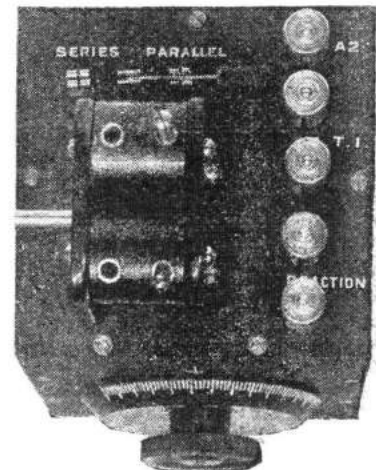

Fig. 1.—A theoretical diagram of the connections.

efficient, due to its short wiring; this being only an inch or two longer than that used in the valve panel. The adjustment of the two



The switch may be seen to the back of the top panel in this photograph.

the back. Now screw the front and top panel on to the box, which may be smoothed down with sandpaper and varnished. Two holes are now tapped for the joining screws, and these screwed home. If the constructor has no taps, holes a little too small to allow the screws to enter can be drilled, and the screws forced into them. Now remove the two panels from the box, and fix the condenser in place.

Wiring

The wiring up can now be carried out. This must be done in accordance with the wiring diagram of Fig. 3. Care should be taken that the wiring clears the moving condenser plates. Now replace the panels, and after fixing panel transfers in accordance with those shown on the photograph of the top panel we are in a position to connect up the panel and try it out. Connection to the valve panel is made by means of pieces of square section wire as shown in the first photograph; the terminals marked A.T.I. and Reaction are joined to the terminals opposite them on the valve panel. It may be found necessary to have the reaction terminals connected the other way

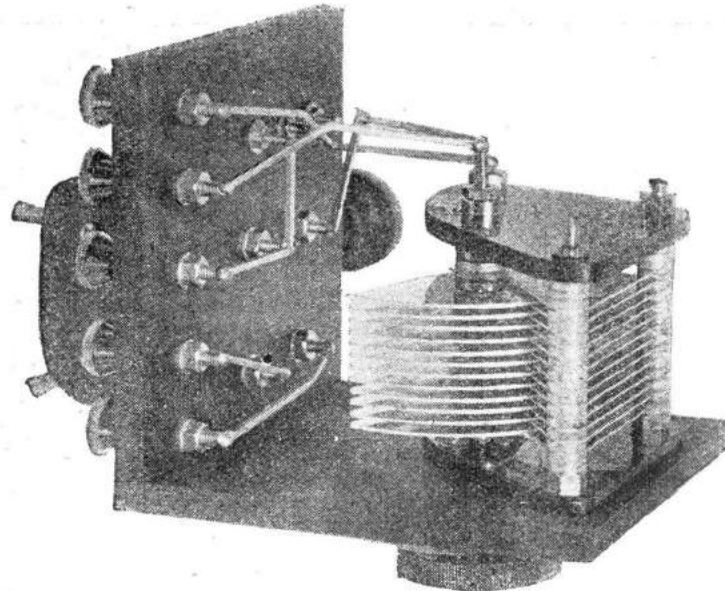

This photograph should be referred to when wiring the tuner.

round to that shown in the photograph, in which case the connecting wires should be of flex.

Using the Tuner

If parallel tuning is required the

aerial is taken to the original aerial terminal, and the switch put in the parallel position, whilst if it is desired to use series tuning, the aerial is connected to the terminal A₂ and the switch is placed in the series position.

When tuning the set to 2LO the reaction coil should be placed right away from the aerial coil, and brought up afterwards in order to increase the strength. When searching for distant stations the coils must only be just close enough together to bring the set to the point just before oscillation.

When using special types of coils with the "Short Wire" valve panel, the condenser of this tuner may be utilised by putting the switch in the parallel position and using the terminals marked A.T.I. as the condenser connections.

In actual use this tuner gave very easy control when receiving in conjunction with the

valve panel, distant stations being brought in with great ease without letting the set go right into oscillation. The author will be greatly pleased to receive accounts of the results which readers obtain with this tuner when used either in conjunction with the valve panel or another set.

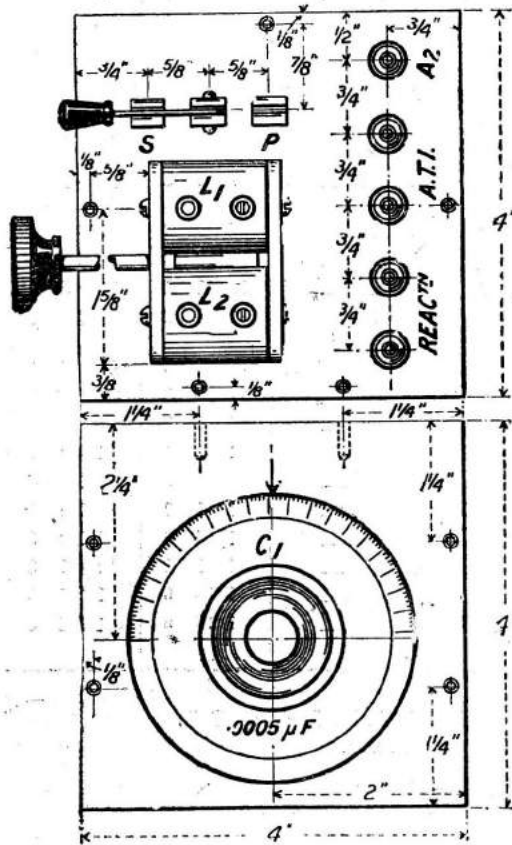

Fig. 2.—This diagram gives the necessary dimensions for drilling the panels.

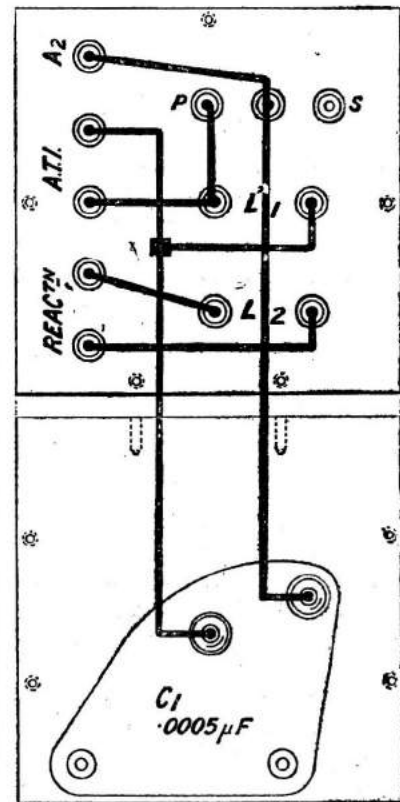

Fig. 3.—The various connections which have to be made are easily carried out from the above diagram.

Reduced Prices of B.T.H. Radio Apparatus

In consequence of the reductions in the prices of B.T.H. Headphones and B.T.H. Radio Valves, coupled with the increased demand for Radiola Receivers, the following revised schedule of prices is current as from February 17th.

Apparatus	Complete with			Old Price £ s. d.	New Price £ s. d.
	Headphones	Valves	Dry Batteries		
Radiola "Bijou" Crystal Receiver	1 set 4000 ohm.	3 5 0	215 0
Radiola "Model A" Crystal Receiver	1 set 4000 ohm.	4 15 0	4 5 0
Loading Device , 1,600 Metres, for above	8 6	8 0
Radiola I. Valve-Crystal Receiver	1 set 4000 ohm.	1 B5	H.T.	11 0 0	10 0 0
Loading Coils 1,600 Metres, for above	17 0	16 0
Radiola II. 2-Valve Receiver	1 set 4000 ohm.	2 B5	H.T. and L.T.	21 0 0	19 0 0
Radiola III. 3-Valve Cabinet Receiver, with enclosed Loud Speaker	1 set 4000 ohm.	3 B5	H.T. and L.T.	50 0 0	49 0 0
Radiola VI. 6-Valve Cabinet Receiver, with enclosed Loud Speaker	1 set 4000 ohm.	{ 4 B5 2 B6 }	H.T. and L.T.	137 0 0	135 0 0
Radiola Portable 3-Valve Receiver, Leather finish.....	1 set 4000 ohm.	3 B5	H.T. and L.T.	28 0 0	27 0 0
Ditto Mahogany finish	" "	" "	" "	30 10 0	29 10 0
Power Amplifier , 2-Valve	2B4 or 2B6	12 10 0	12 0 0
Unit Amplifier , 1-Valve	2 15 0	2 15 0
Portable Loud Speaker & Amplifier , Leather finish	2 B6	H.T. and L.T.	24 0 0	23 10 0
Ditto Mahogany finish	" "	" "	26 0 0	25 10 0
Headphones 4,000 ohms.	1 5 0	1 0 0
Headphones 120 ohms.	1 2 6	1 0 0
R Valve	12 6	11 0
B3 Valve	1 1 0	18 0
B4 Valve	1 15 0	1 10 0
B5 Valve	1 5 0	1 1 0
B6 Valve	1 15 0	1 10 0
B7 Valve	1 17 6	1 12 0

The new price of the Radiola, II 2-valve Receiver includes Loading Coils (1600 metres) for the High Powered Station.



Advertisement of The British Thomson-Houston Co. Ltd.

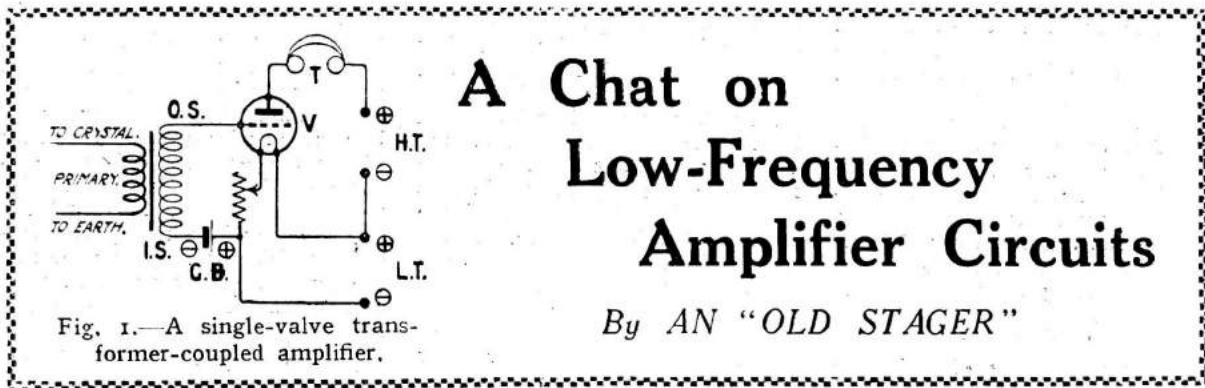

THE most simple and probably the most popular low-frequency amplifier circuit is that using transformer coupling. Now the two great advantages of transformer coupling are, first, its great simplicity, and, second, its high amplification per valve. Fig. 1 shows the method of connecting a single-stage L.F. amplifier to an existing crystal receiver. The transformer primary should merely be connected to the existing telephone terminals, and it is usual in the majority of transformers for the outside secondary (O.S.) terminal to be taken to the grid of the amplifier valve. The other secondary terminal on the transformer,

series, then a small grid cell of 1.5 volts is certainly necessary. The use of grid bias improves quality and cuts down the plate current, thereby lengthening the life of the H.T. battery. The remaining connections will be easily followed from the diagram.

Capabilities

The Fig. 1 circuit is capable of giving strong signals in several pairs of telephones at a distance of about 15 miles

bias and, of course, without knowing the type of valve to be used, it is impossible to give definite instructions as to the necessary grid bias to apply in every case. The

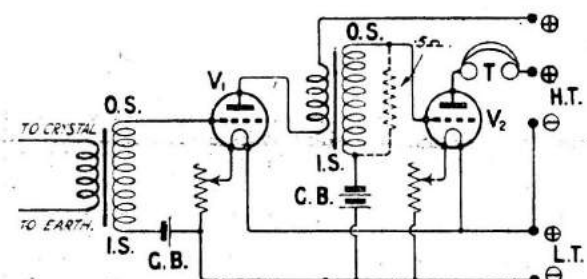

Fig. 2.—A two-stage transformer-coupled amplifier.

i.e., in this case the I.S. connection, should go to the negative terminal of a small dry cell, termed the grid battery, the positive terminal of which should be connected to the L.T. minus. If an ordinary bright-emitter valve is used in conjunction with a 6 volt accumulator, the drop in volts across the filament rheostat will give sufficient grid bias for H.T. voltages of about 60, which is a suitable anode voltage for a circuit of this description, and the grid cell will not be necessary. In this case the I.S. connection from the transformer should be taken direct to the lower end of the filament resistance. If, however, dull-emitter valves of the 2 volt type are used in conjunction with a 2 volt accumulator, or valves of the '06 type with two dry cells in

a two-stage transformer-coupled amplifier suitable for use with a crystal set. In this circuit two separate positive tapplings to the H.T. battery are provided, for this results in greater efficiency. The voltage applied to the plate of the last valve should be greater than that in the case of the first. Suitable H.T. values are, for V₁, say 60 volts, and for V₂ about 90-100 volts, with a negative grid bias of about 1.5 volts in the first case, and about 3 volts (two dry cells connected in series) in the case of V₂. The remarks regarding the drop in volts across the filament rheostat given above apply in all cases throughout this article and should be taken into consideration when calculating the total negative

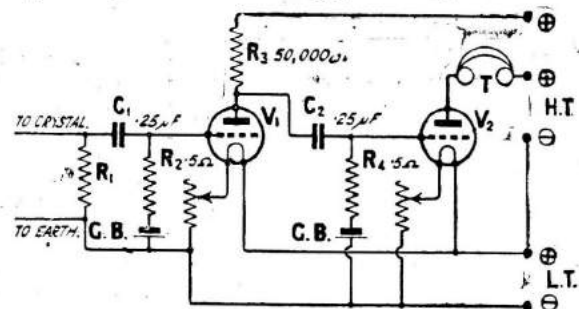

Fig. 3.—A two-stage resistance-coupled amplifier.

from a main broadcasting station, but where signals are really weak in the first instance, transformer coupling is not very efficient and in most cases will give a disappointing increase in strength.

enthusiast should always follow out the valve manufacturers' instructions. This circuit should be capable of operating a small loud-speaker up to a distance of about 10 miles from a main B.B.C. station.

Improving Quality

If the constructor is willing to sacrifice a little volume, quality may often be improved by shunting the secondary winding of the last transformer with a resistance of about .5 megohm, as shown dotted in the diagram. The listener who is desirous of obtaining faithful reproduction will find that the construction of a

Two Stages

Fig. 2 shows

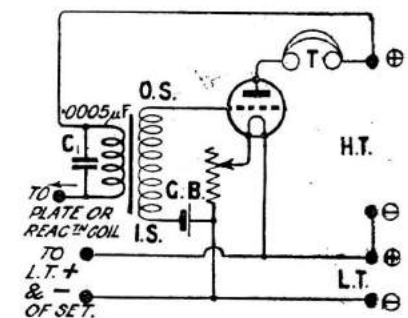

Fig. 4.—A transformer used after a detector valve.

resistance-coupled amplifier will meet these requirements. Resistance-capacity amplification, unfortunately, does not give the same amplification per stage as transformer coupling, but nevertheless a well-designed resistance amplifier will certainly give remarkable purity and is well worth making. Fig 3 shows a two-stage resistance amplifier suitable for attachment to an existing crystal receiver.

Some Rules

If the advantages of resistance coupling are to be obtained, then it is necessary that certain definite rules should be obeyed. The grids of both valves must be made negative by the application of

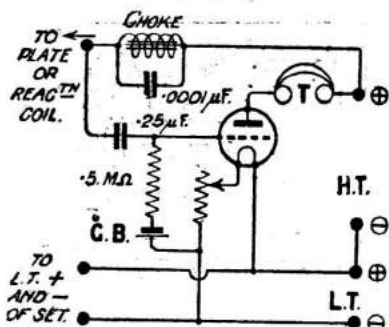

Fig. 5.—Choke Coupling.

the proper grid bias, the H.T. voltage should be greater than in the case of transformer coupling owing to the drop in volts across the anode resistance, and the anode resistance itself should be of good quality. The resistance R_1 is not critical, but should be kept low for good results and may be between 100,000 and 250,000 ohms. R_2 and R_3 should be about .5 megohm, and R_3 may be 50,000 ohms in cases where ordinary general-purpose valves are used. The values of the coupling con-

densers C_1 and C_2 are not critical, but .25 μ F is a good value. For best results separate positive H.T. tappings should be used and the H.T. voltage applied to V_1 should be in the neighbourhood of 120 volts on account of the anode resistance R_2 ; 1.5 volts grid bias should suffice in the case of the ordinary "R"-type valve. In the case of V_2 the plate voltage may be lower as there is no anode resistance in series, and 80-100 volts will be found sufficient with a negative bias of about 3 volts. For other types of valve the maker's advice should be followed.

After a Valve

We now have to consider the case where a low-frequency amplifier follows a valve detector. The rules which apply to the above circuits apply in general where a valve is used as a detector in the place of a crystal. Where reaction is used, however, it is essential that a small fixed condenser C_1 , as shown in Fig. 4, should be shunted across the primary winding of the I.F. transformer.

By-Pass Condenser

This condenser is necessary to by-pass the high-frequency component of the anode current, and should be kept as small as possible consistent with efficient operation. A good average value is .0005-.001 μ F. In Fig. 5 is shown a circuit utilising reactance-capacity, or choke coupling. This method will not give such high amplification as the transformer coupled method, but from the point of view of signal strength is slightly better than resistance-capacity coupling. It is particularly useful in cases where the listener is in possession of a transformer with a defective primary

winding as the secondaries of most transformers make fairly good chokes, and, moreover, excellent quality may be obtained. Where reaction is used the winding should be shunted with a small condenser of about .0001 μ F. This value is not critical, but for good results it should be kept low, and the above value will generally be found quite satisfactory. The values of the grid condenser and leak may be as shown in the diagram, and a suitable plate voltage is from 60-72 volts for ordinary general purpose valves. Lastly we have in Fig. 6 a single-stage resistance amplifier suitable for use with a valve detector. Separate H.T. tappings are shown on account of

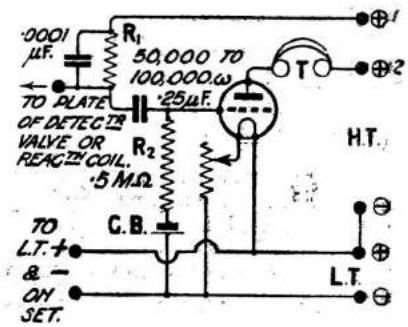

Fig. 6.—Resistance coupling after a valve.

the anode resistance R_1 in series with the plate of the detector valve. As in the case of choke coupling, where reaction is used the anode resistance should be shunted with a small fixed condenser of about .0001 μ F, and the plate voltage should be adjusted to compensate for the drop across the resistance R_1 . A suitable value of H.T. for the amplifier valve itself is about 60-90 volts, with a negative bias of 1.5-3 volts.



Just like a man !

UNCONDITIONAL GUARANTEE.

To replace free of all charge any Paragon Curtis One Piece Mica Condenser, which may break down or otherwise be defective from any cause whatsoever other than mechanical fracture for a period of five years from date of purchase. We have decided to extend to all users of Paragon Curtis One Piece Mica Condensers our maintenance guarantee given to users of the Paragon Curtis Submarine Cable Telegraph Condensers.

MAXIMUM EFFICIENCY

must begin with design and be sustained through all the processes of manufacture if maximum efficiency has to be uniformly guaranteed.

The design and methods of manufacture of the PARAGON-CURTIS ONE PIECE MICA CONDENSER can alone guarantee uniform accuracy under all conditions and at all temperatures.

PARAGON-CURTIS ONE PIECE MICA CONDENSER.



ESSENTIAL FOR PERFECT RECEPTION and ABSOLUTELY INDISPENSABLE for tropical and extreme climates.

Test Report by A. D. COWPER, M.Sc., Staff Editor "Modern Wireless."

ACCURACY.

"On test, the capacities came out quite close enough to the nominal for ordinary radio purposes, the .001μF nominal samples being about .00103 and .00091 respectively, and the .0003μF nominal being actually around .00033 and .00026 respectively. There was observed but a negligible greater high-frequency loss in this type than in a standard air-dielectric condenser.

PERMANENCY

"As this one piece casing offers apparently considerable advantages as to permanency and independence of damp, high temperature, etc., an exceedingly strenuous test was applied to one of the samples, which was actually placed in water nearly at the boiling point for the better part of an hour. After this heroic treatment, the condenser showed a capacity which did not differ materially from that shown before and it was still possible to get a valve to oscillate readily with this as the main tuning-capacity across the grid-tuning-inductance. Evidently there need be no fears as to possible deterioration in stock of these 'Paragon-Curtis' fixed condensers."

- .0008 to .0006 2/6 each.
- Grid Condenser with clips 2/9 each.
- Grid Leak 1/6 each.

Sales Organisation:

PETER CURTIS, LTD.
IN CONJUNCTION WITH

The Paragon Rubber Mfg. Co., Ltd., Hull
75, CAMDEN ROAD, N.W.1.

Telegrams: "PARACURTEX." Telephone: NORTH 3112

CURTIS VARIABLE MICA CONDENSER

ELIMINATES THE MANY DEFECTS IN THE EXISTING TYPE OF CONDENSER

The Curtis-Microhm Variable Mica Condenser—a precision instrument of very high efficiency—is scientifically designed to eliminate the disadvantages of the open vane type.

This Condenser, which, in every sense of the word, is in advance of accepted Condenser design, gives a Square Law Reading. In operation there is no backlash, since its precision gives "dead beat" action.

Many other obvious advantages may be enumerated. No moving connections; thus precluding any possibility of noise caused by faulty contact or mechanical weaknesses. Very low minimum; to be exact the capacity ratio in the Curtis-Microhm is 500:1—an advantage at once apparent. No interaction from adjacent components. Absolutely dust-proof, single hole fixing and most compact in design.

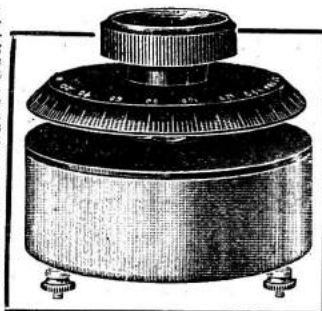

Essential for the perfect reception in all circuits; indispensable for Super Heterodynes.

For full particulars see Press Notices.

.001 Mfd.; .0005 Mfd.; .00025 Mfd.

Price 13/6

Distinctive

By no means the least important feature is the uniform ebony black, fine grain, dead matt surface so distinctive of and exclusive to

PARAGON Radio Quality Post Office Specification "The Best Made" EBONITE PANELS

Sold everywhere in Sealed Cartons only stamped Paragon

All "Modern Wireless" and Radio Press Panels supplied from Stock at 1d. per sq. in. Prices for drilling and engraving upon request

STANDARD SIZES:

8 x 6	2/6	24 x 10	14/6	18 x 6	6/9
8 x 6	3/3	24 x 12	17/6	12 x 8	6/-
10 1/2 x 8 1/2	5/3	8 x 5 1/2	2/9	10 x 8	6/9
12 x 10	7/3	10 1/2 x 7	4/7	7 x 5	2/3
12 x 12	8/6	12 x 6	4/6	10 x 9	5/6
14 x 12	10/-	22 x 11	15/3	9 x 5 1/2	3/5
16 x 12	11/6	16 x 9	9/-	10 x 5	3/3
18 x 12	13/-	12 x 11	8/3	12 1/2 x 9 1/2	7/6

As used by British Government Departments, and specified by the leading Technical Journals.

PARAGON POLISHED MAHOGANY EBONITE THE NATURAL COLOUR OF NATURAL MAHOGANY

PANELS CUT TO SIZE, Squared, edges ground, 1d. per square inch. Valve and Coil Holders, Condenser Dials and Knobs in Polished Mahogany Finish to match.

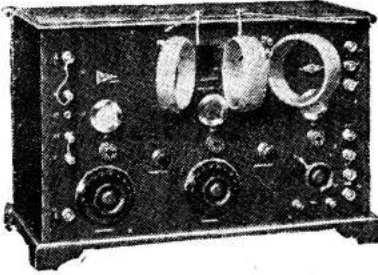

THE ALL-BRITAIN SET.

A wonderfully popular 3-valve Set, which, as its name implies, is capable of receiving all the main B.B.C. stations at good strength. A very simple Set to operate, and recognised as being very selective. Uses the new tri-coil circuit.

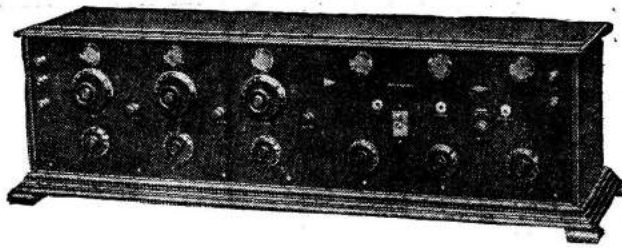

THE ANGLO-AMERICAN SIX.
"The Wireless Constructor" latest Set embodying three stages of neutrodyne high frequency. Gives practically the power of a super-heterodyne with a great saving in valves. A few feet of wire around the picture moulding of a room is all that is necessary to operate this Set.

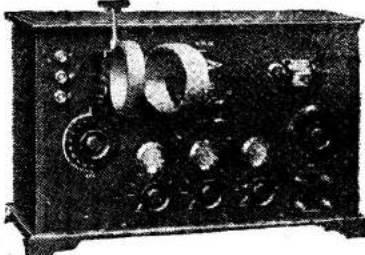

THE PURIFLEX SET.

Originally designed for "Modern Wireless" by Mr. Percy Harris. Uses a Crystal Reflex circuit with a two-stages of resistance coupled low-frequency amplification. Famed for its remarkable loud-speaker purity of reproduction. There is a complete absence of distortion with the Set.

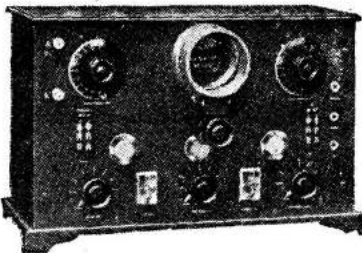

THE ALL CONCERT-DE-LUXE.

A most handsome Receiver with all fittings supplied nickel-plated. Simple switches enable note magnifier valve being cut out if not required. Has a telephone range of 800 to 1,000 miles under normal conditions. All battery connections at rear, and plugs and jacks for telephones and loud-speaker fitted to panel.

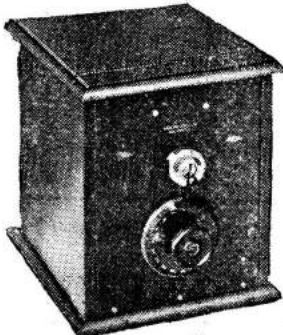

"MODERN WIRELESS" WAVEMETER.

Every Wireless enthusiast needs a wavemeter. It tells him the wavelength of the station he is receiving. On the other hand, should he want to receive a station working on a known wavelength, he can easily tune his Set to that wavelength by means of the wavemeter. Price complete with battery and Silvertown buzzer fully calibrated ready for use. In mahogany or oak cabinet £15 0.

Amateur-built Receivers that any Expert would be proud to own.

If you can use a pair of pliers to cut a length of wire—if you can screw a transformer to a ready-drilled panel—if you can follow a simple wiring diagram, then you can build any of the splendid Sets illustrated on this page. From the 2-valve Resistoflex to the 6-valve Anglo-American designed by Mr. Percy Harris for "The Wireless Constructor," they represent all that is best and most original in British Radio design to-day.

Every one of these Pilot Receivers carries our full guarantee that if made according to our working instructions they will work perfectly. Indeed, we go further than that—we have insti-

tuted a special Service Department to ferret out faults for you at a nominal cost should the Set not work when you have made it up.

Choose the best Set you can afford from the chart herewith—if you have some of the parts already, we shall be pleased to supply you with the balance. If you have all the parts already, we shall be equally pleased to supply you with only the panel or the cabinet. If you cannot make up your mind which Set you will build, write for a copy of our 32-page Pilot Chart (post free 3d.), containing upwards of 30 illustrations of Pilot Receivers with the fullest details.

This abridged Chart will aid you in your choice

Name of Receiver.	No. of Valves	Price of panel drilled & engraved		Kit of Components.		Oak Cabinet with baseboard.	
		£ s. d.	£ s. d.	£ s. d.	£ s. d.		
All Concert de luxe	3	15 6	4 15 6		17 0		
S.T. 100	2	7 0	4 14 0		1 10 0		
Puriflex	3	15 6	4 2 0		17 0		
All-Britain	3	15 6	4 16 1		17 0		
4-Valve Family	4	17 0	5 16 8		17 0		
Transatlantic V.	5	18 6	5 8 5		17 0		
Anglo-American 6	6	1 8 6	9 9 9		3 1 6		
Transatlantic 4	4	16 6	6 13 6		1 7 6		
3-Valve Neutrodyne (Valve panel)	3	12 0	4 8 8		1 13 6		
3-Valve Neutrodyne (Tuner panel)	—	11 6	4 2 3		(to take both panels)		
T.A.T. 4-Valve Set	4	1 0 6	5 15 6		1 0 0		
Harris Wavemeter	—	4 6	1 6 0		12 6		
3-Valve Dual	3	17 0	5 5 0		15 6		
Simplicity Receiver	3	12 0	3 16 0		10 6		
7 Valve T.A.T. Receiver	7	1 17 6	7 18 0		1 12 6		

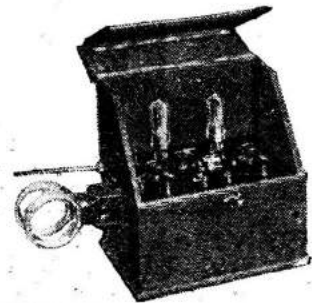

THE S.T. 100.

The world's Standard 2-valve Reflex which gives probably the loudest signals it is possible to obtain with two valves. Tens of thousands of S.T. 100 Receivers have been built in America, although the circuit was first evolved by Mr. John Scott-Taggart (Editor of "Modern Wireless"). This Set is contained in a handsome oak double drop front, and possesses a most attractive appearance.

SPECIAL NOTE: Where all components and panel are purchased together, a Marconi Royalty of 12s. 6d. per valv-holder must be paid.

To get the full list of parts necessary for 30 different Receivers, send 3d. to-day for the Pilot's Chart

If the 7 different Sets shown here are not suitable for you, send 3d. at once for a copy of our 32-page Booklet giving illustrations of 30 different Receivers—ranging from simple Crystal to elaborate multi-valve Sets. A full detailed list of every component required for each Receiver. An invaluable little Booklet for the Home Constructor. In addition, we also issue a 48-page fully illustrated catalogue (the most complete in the trade) of Wireless Components, post free 3d.; and also Peto-Scott's Wireless Book, post free 1s. 5d., containing more than 30 Circuit diagrams.

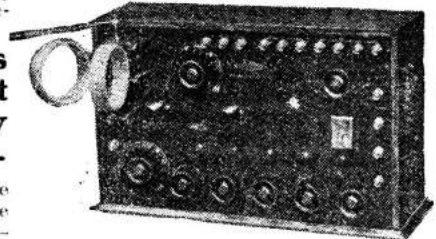

THE TRANSATLANTIC V. RECEIVER.

The first standard Set to use two stages of high-frequency amplification. A real long-distance Set. Will work particularly well on a simple little indoor aerial. Regular reception of American broadcasting and long-distance Continental stations at loud-speaker strength is an easy matter with this 5-valve Set.

PETO-SCOTT Co., Ltd., 77, CITY ROAD, LONDON, E.C.1.

Registered Offices, Mail Order & Showroom:
 Branches: LONDON—62, High Holborn, W.C.1
 WALTHAMSTOW—230, Wood St.
 PLYMOUTH—4, Bank of England Place. LIVERPOOL—4, Manchester St. CARDIFF—94, Queen St.
 P.S. 2295

A Unit Choke Amplifier

(Concluded from page 505)

than one stage of low-frequency amplification) as shown in Fig. 4. You must first of all ascertain two things. Firstly, which telephone terminal goes to the plate of the last valve, and, secondly, whether the H.T. - is joined to the L.T. + in the set. This latter must be the case.

The telephone terminal of your set which is internally joined to the plate of the valve (perhaps through a reaction coil) must be joined to the lower of the two "input" terminals on the amplifier, the other telephone and "input" terminals being joined together. The H.T. + terminal on the set is taken to a tapping on the high-tension battery corresponding to the voltage recommended by the makers of the valve used. The other connections are made clear in the drawing.

Coming now to the right-hand row of terminals on the amplifier, the top of the two "out" ter-

minals is joined to the positive terminal of the 'phones or loud-speaker (usually marked in red). H.T. + goes to a suitable tapping on the battery; HT- goes to the negative of the H.T. battery, while the L.T. + and - terminals are joined to the accumulator.

Now turn on the filaments of the valves and tune your set in the ordinary way. Do not turn up the filament any brighter than is necessary to get the best results. For a single-stage amplifier, using normal H.T. voltage, the two grid-bias terminals may be joined together by a piece of wire.

Using Two Stages

Two stages may be used by joining up two units, as seen in Fig. 5, the output of the first unit being directly joined to the input of the second. Both the H.T. negative terminals, on the set and first unit, may be left free, and a lead taken to HT- from the terminal on the last unit.

A small cell may be joined across the grid-bias terminals on the second unit if necessary, but the first unit should not require biasing if normal voltages are used.

Crystal Sets

If you are a crystal set owner, and desire to add valves, I advise you to make up one unit without the choke, connecting the telephone terminal of your crystal set which goes to the crystal directly to the grid of the valve, and the other telephone terminal to L.T. - on the left-hand side of the unit. A second stage may be added, using the choke this time, as seen in Fig. 5.

Results

One stage, after a single valve with reaction, and at six miles from 2L.O. are the conditions in which a preliminary test was made. Purity was remarkable, being what Capt. Eckersley refers to as "pure music coming from a background of silence." Everyone who has heard the reproduction from this arrangement on a standard C.A.V. loud-speaker has remarked upon its excellence. The volume is not quite up to a good transformer, but is better than many, with considerable increase in faithfulness of reproduction.

When you have made it up, write and tell me what you think of it, but don't use "any old choke" and then blame the design.



The pirate bold!

HULLO EVERYBODY!!

REVOLUTION IN VARIABLE CONDENSERS SQUARE LAW LOW-LOSS (SQUARE-LO-LOSS) with VERNIER

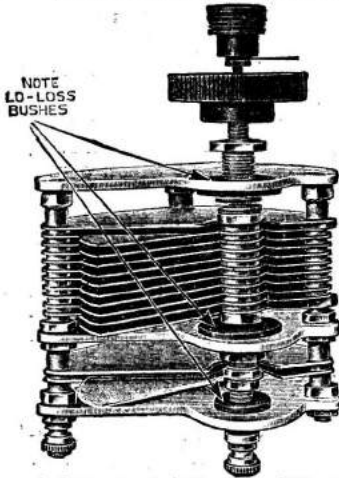

NOTE LO-LOSS BUSHES

The only Condenser with the Low-Loss Bushes. Electrical losses reduced to a minimum.

Full capacity as rated.

Exceptional Low Capacity.

The Condenser for Short wavelengths.

Why buy a Condenser without Vernier when one WITH costs no more.

SQUARE LAW WITH VERNIER
Including Knob and Dial (Ebonite Ends 1/- extra) Trade Supplied. Post 6d. set.

·001	:	:	8/9
·0005	:	:	7/9
·0003	:	:	7/-

RAYMOND VARIABLE CONDENSERS SQUARE LAW
One-hole fixing. EBONITE Bushes. Aluminium ends. Highly recommended.

With Vernier		Without Vernier	
·001	-	8/9	·001 - 7/7
·0005	-	7/9	·0005 - 5/9
·0003	-	7/-	·0003 - 5/3

Ebonite ends 1/- extra. Ebonite ends 1/- extra. Post 6d. Set.

LE LUXE ORDINARY
Complete with Knob and Dial

·001 aluminium ends	-	6/11
·0005	"	5/6
·0003	"	4/11
·0002	"	4/6

Post 3d. Set.

TWIN CONDENSERS
Equal parts of ·0005, ·0003 and ·00025.
With Knob and Dial.
Ebonite Ends.

·0005 ebonite ends	-	18/11
·0003	"	12/6
·00025	"	12/6

LONDON'S LARGEST Stockist of JACKSON BROS.'
J.B. Variable Condensers, complete with Knob and Dial.

SQUARE LAW		STANDARD	
·001	-	9/6	·001 - 8/6
·0005	-	8/-	·0005 - 7/-
·0003	-	6/9	·0003 - 5/9
·0002	-	5/6	·0002 - 5/-

Other sizes as advertised by "J.B." Post 4d.

LOUDEN VALVES

Plain Type.
For detecting and L.F. Amplifying. Blue Louden.
For H.F. Amplifying. Fil. voltage 4-5 to 5. Fil. current 0-4 amp. Plate 40-80. NOW

8/6
each. Post 6d. each. Purchaser's risk.

HEADPHONES

ERICSSON E. V. CONTINENTAL.
Your favourite 'phones. Entirely NEW MODEL Most beautifully finished, exquisite tone. Ridiculous Price per pair (4,000 ohms)

13/11

ENERGOL.F. TRANSFORMER.

For supreme results, Efficiency, Finish, and Permanent Reliability.
For 1st Stage, 15/-

N & K

GENUINE LATEST MODEL, 4,000 ohms, 15/11
FEW OLD MODEL 12/11
POST 6d. pr. U.K.

GENUINE 'BRUNET'

L.F. Transformers. 3-1 (Primary 5,000) Secondary 15,000
5-1 Primary 500 5-1, Primary 5,000, Secondary 25,000.
13 6 each.

BRUNET

New Model "TYPE D." Hygienic Horn Headbands. Nickel-plated Strrup. Black and White Cord. Each receiver stamped with trade mark. 40.00 ohms. per pair 16/6

Warning! Note name RAYMOND on Windows. You will not be able to buy these goods otherwise. Nearest Tube Leicester Square. This address is at the back of Daly's Theatre. Open weekdays 9 to 8. Saturdays 9 to 8.45. Sundays 10 to 1.

3 COLUMNS FOR CALLERS ONLY ALL POST ORDERS FROM OTHER COLUMNS

Insulated Hooks 2 for 1d.
Egg Insulators 4 for 3d.
Insulated Staples 5 a 1d.
Battery Links 4 for 2d.
6 ft. 'Phone Cords 1/- 1 3/16
Sleeving 12 yds. 3d.
Empire Tape 12 yds. 6d.
Red and black flex 12 yds. 1/6
Wander Plugs 1d.
Tape Aerial 100 ft. 1 10
7,22 hard drawn, 100 ft. 1 10
1/16 Bus Bar hank 6d.
Lead-in tubes 6d.
Ormond Rheostat 1 8
C. & S., Good value 1/-
Raymond, with dial 1 11
Twin silk tnx 6 yds. 6d.
Baby 2-Way coil stand 1 9
Do. 3-way coil stand 3 8
2-way ex-handles, nickel 2 9
3-way ex-handles, nickel 4 6
H.F. Transformer, B.B.C. 2 6
Ditto, Chelmsford 2 9
O.P.D.T. Panel switch 1/-
S.P.D.T. Panel switch 10 1d.
D.P.D.T. China base 1 2
J.P.D.T. China base 7 1d.
On & off switch 1/-
Legless valve holder 1/-
Solid rod valve holder 1 3
H.T.C. both types. Basket holders, 7d., 8 1d.
Also at 10d., 11d., 1/-
Spike holders 7d., 9d.
Knobs, 2 B.A. 2d.
Brass coil former 2 3
4-5 batteries, 4d., 4 1d., 5d.
Dutch detectors 4 3
Fama detectors 4 9
Dutch "R" valves 4 9
Phillips "R" 6 11
French "R" 5 9
Radio Micro '05 10 11
"Metal" '06 10 6
Dr. Nesper 'phones 11 9
Ericsson E.V. 'phones 10 11
Telefunken Type 8 11
N. & K. Pattern 7 11
Glazite 1 6
Breast drills 4 9
Set of drills 1 2
Screw drivers 3d.
Spanners (5) 4 1d.
Pliers 10 1d., 1/-
7 waxed coils 1 8
5 waxless coils 1 4
Whiskers 1d., 2d., 3d.
Set of 4 2d.
Copper foil 2 1d.
Mansbridge 1 mid. 3 3
Ditto, 2 mid. 3 9
Ditto, .25 2 8

TERMINALS. (Complete.)
W.O., Pillar, 'Phone, brass, 1d. each; nickel, 2d. each; stop and valve Pins, 1d.; nuts, various, 6 a 1d.
Valve Sockets 1d., 1 1d.
Flush panel do. 1d.
Spade Tags 6 a 1d.
Do. Terminals 2 for 1 1d.
Do. Pins 2 for 1 1d.
Screws and nuts 2 a 1d.
Switch arms 7d.
Nickel arms 10 1d.
Studs, complete 2 a 1d.
'Phone connectors 1d.
2 B.A. Rod 1/2 it. 2 1d.
4 B.A. Rod 1/2 it. 2d.
Valve Windows 4d.
Washers 12 a 1d.
Snorting plug and socket 3 1d.
Shellac 5d.
Ormond (Neutrodyne) 2 6
Colvern 3/-
Success 3 6
Vernier (Colvern) 2 6

ACCUMULATORS.
2 v. 40 amps. 9 6
4 v. 40 amps. 16 6
4 v. 60 amps. 18 6
4 v. 80 amps. 23 6
6 v. 60 amps. 27 6
6 v. 80 amps. 33 6
6 v. 105 amps. 38 6
Hart's Stocked. All High Quality.

EBONITE, 3 1/2 in. Stock Sizes.
Cut to size, 1d. sq. in.
6x6 1/4 12x6 3/-
7x5 1/4 12x9 4 3
8x6 1/10 12x12 5 6
9x6 2/- 14x10 5 6
10x8 3/-
1-in. also Stocked.

JWITCH A.H.M., one-hole fixing. 12 Studs, 12 Nuts, 12 Washers. Lot 10/d.

COLL FLOWS, EBONITE Fitted Fibre 7d. Wedge Shape 7d. Edison Bell 11d. Plincoil Plugs 4d. Also 5d., 6d., 7d. each. Fibre Strip 2d. (36 in. by 1 in.) Empire Tape, doz. yds. 6d.

RAYMOND FIXED CONDENSERS.
·001, ·0001 to ·0005, 10d.
·002, ·003, ·004 1/-
·006, 1/3; ·01, 1/9; ·02, 1/9
Ebonite Base Terminals.

ENCLOSED DETECTORS
Micromer 1 6
Half Opal 1/-
Small Brass 8d.
Large Brass 1/-, 1 3
Nickel 10d. to 1 6
Barddept 4 4
Shaw's Genuine Hertzite 10d.
Uralium 1/-
All known makes.
4 Whiskers (1 gold) 2d.
Gold and Silver do. 2d.
7 Waxed Coils 1 8
5 Waxed Coils 1 3
(For B.B.C.)

SPECIAL!
Vernier 2-way Coil Stands 3 3
Geared do. 5 3

VARIOMETER WITH DIAL.
Ebonite former 2 11

SPECIAL!
Square Law Variable Condensers.
·0005 5/-
·0003 4/6
Complete with Knob and Dial.
Ebonite ends, 1/- extra.

WARNING!
Buy Shaw's Hertzite, only in sealed box, bearing facsimile signature of J. J. Shaw. Not genuine otherwise.

RIGHT OPPOSITE DALY'S GALLERY DOOR

K. RAYMOND

27, LISLE STREET, LEICESTER SQUARE, W.C.2

No responsibility accepted on post orders unless cheques and postal orders are crossed and made payable to the firm. Moneys sent must be registered

HOURS OF BUSINESS:
DAILY . 9 to 7.45
SUNDAY . 10 to 1
Phone: GERRARD 4637

HULLO EVERYBODY!!

Aerial 7/22 100 ft.	2/-	By post 2/6
Copper Tape, 100 ft.	2/-	By post 2/6
Basket Holder and Plug	10d.	By post 1/1
Do. best quality, and Plug	1/-	By post 1/3
Do. Spoke and Plug	9d.	By post 1/1
Bretwood Valve Holder	1/9	By post 1/9
Bretwood Variable Grid Leak	3/-	By post 3/6
Bretwood Anode Resistance	3/-	By post 3/6
Walmel Variable Grid Leak	2/6	By post 2/6
Walmel Anode Resistance	3/6	By post 3/6
Coil Stands, 2-way	2/6	By post 2/9
Coil Stands, 3-way	3/6	By post 4/6
Do. ex. handles, nickel, 2-way	3/8	By post 3/8
Do. ex. handles, nickel, 3-way	4/8	By post 5/8
Do. geared, 2-way	5/3	By post 5/6
Do. Cam Vernier, 2-way	3/9	By post 4/8
Coil Plugs, Ebonite	8d.	By post 10d.
Do. Wedge shape	10d.	By post 1/1
Do. Edison Bell	1/-	By post 1/2
Do. Fibre Winding Arms	9d.	By post 1/1
Do. with Clips	9d.	By post 1/1
DUBILIER FIXED Condensers.		
.001, 2, 3, 4, 5, 6	each 3/-	By post 3/6
.0001, 2, 3, 4, 5	each 2/6	By post 2/6
.0003 and Grid Leak	5/-	By post 5/6
2 Meg. Grid Leak	2/6	By post 2/6
Anode Resistance on Stand (50,000, 70,000, 100,000 ohms.)	5/6	By post 5/6
BURNDEPT Detector		
Do. Dual Rheostats	4/-	By post 4/3
Do. Dual Rheostats	7/6	By post 7/6
Enclosed Detectors	1/-	By post 1/3
Do. large size	1/6	By post 1/9
(Nickel, Ebonite or Brass Fittings.)		
Micrometer adjusted	1/9	By post 2/2
Fixed Con., Ebonite base, .001 to .0005	each 10d.	By post 1/2
Do. .002 to .006	each 1/4	By post 1/3
Do. .001 and .02	each 1/9	By post 1/11
EDISON BELL, .001 to .0005		
Do. do. .002 to .006	each 2/-	By post 2/2
.0003 and Grid Leak	2/6	By post 2/8
Twin Flex	12 yds. 1/6	By post 1/9
Do. Red and Black	12 yds. 1/8	By post 1/10
Do. Miniature Silk	12 yds. 1/-	By post 1/6
Lead-in, 3 m/m	10 yds. 1/3	By post 1/6
Lead-in, Heavy	6 yds. 1/6	By post 1/10
Rheostat, C. & S.	1/-	By post 1/3
Rheostat and Dial	1/11	By post 2/3
Ormond	1/9	By post 1/11
Finston, with Dial	1/9	By post 2/2
Crown Rheostats (D., E., or R.)	2/2	By post 2/6
L.E.S. Micro Control (D., E. or R.)	3/6	By post 3/6
Switch arms (1-hole fixing)	9d.	By post 1/1
Nickel Arms (1-hole fixing)	1/-	By post 1/3
Panel Switch, D.P.D.T.	1/-	By post 1/3
Do. S.P.D.T. (both nickel)	10d.	By post 1/1
Bus Bar, 1/16 sq., 12 ft.	8d.	By post 1/1
Terminals, "Phone"	doz. 1/-	By post 1/3
Do. W.O. or Pillar	doz. 1/-	By post 1/3
Do. above, Nickel	doz. 1/8	By post 2/2
Studs, Nuts and Washers	doz. 6d.	Post free U.K.
Valve Legs and Washers	doz. 1/3	Post free U.K.
Flush Panel Sockets	doz. 1/3	Post free U.K.
Spade Screw Terminals	doz. 1/-	Post free U.K.
Pin Screw Terminals	doz. 1/-	Post free U.K.
Shorting Plug and Socket	6d.	Post free U.K.
McMichael's H.F. Transformers, 300, 600 10-		
Do. do. 1,100 3,000	10/-	By post 10/10
Do. do. 100,000 ohm Res.	2/6	By post 2/6
Do. do. Dual Rheostat	7/6	By post 7/6
(For D.E. or R. Valves.)		
ENERGO H.F. Transformers No. 1, 150 450 3/6		
Do. do. No. 2, 250 700	3/11	By post 3/8
Do. do. No. 3, 450 1,200	4/3	By post 4/8
Do. do. No. 4, 900 2,000	4/6	By post 4/8
Do. do. No. 5, 1,600 3,000	4/9	By post 5/1
Do. L.F. Transformers	15/-	By post 15/15
UTILITY Switches Stckd, 2 Pole c/o Knob type		
Do. do. 2 Pole c/o Lever type	4/-	By post 4/2
Do. do. 4 Pole c/o Knob type	5/-	By post 5/2
Do. do. 4 Pole c/o Lever type	6/-	By post 6/2
FRENCH "R" Valves		
DUTCH Detectors	7/6	By post 7/6
Dutch .06 (1-8 to 2 v.)	5/9	By post 5/2
(Purchaser's risk on post.)	4/9	By post 5/2
Variometers, good value	1/9	By post 2/3
Do. Ebonite, with dial	3/11	By post 4/6
Do. similar to Igranic	6/11	By post 7/8
Do. Edison Bell	10/-	By post 10/10
Do. Igranic	10/-	By post 10/10
Ebonite Valve Holders	1/-	By post 1/3
Do. Legless Valve Holders	1/-	By post 1/3
Murray Anti-cap. Holders	1/3	By post 1/3
Barrie Anti-cap. Holders	1/3	By post 1/3

NOTE NEW REDUCED PRICES on post orders. ALL ORDERS over 50/- will be sent post free U.K. only. Foreign orders must include postage as shown on each article, and in the case of goods marked post free in U.K. only, must have extra cash for post and packing abroad.

H.T. BATTERIES.
 B.B.C., 60 volt .. 8/11
 By post 10/-
 B.B.C., 36 volt .. 5/6
 By post 6/6
 Best made 60 volt .. 6/11
 By post 7/11
 Eveready, 66 volt .. 13/6
 Post free.
 Eveready, 108 volt .. 22/6
 Post free.
 Eveready, 36 volt .. 7/-
 Post free.
 Eveready, 4.5 flash lamp, dozen, post free U.K. 7/6

QUALITY (GOSWELL) RADIO COILS
 Far more efficient than honeycomb or any other type of coil. Exceedingly strong and rigid, mounted on standard ebonite plugs. Brown finish, no wax or shellac used. MOUNTED.
 25.. 1/6
 35.. 1/9
 50.. 2/0
 75.. 2/3
 100.. 2/9
 150.. 3/0
 175.. 3/6
 200.. 3/9 Post 3d. Coil



GOSWELL QUALITY.
 Valve Legs, Set 4 .. 1/3
 Valve Holder .. 1/9
 2-way Cam Vernier .. 9/-
 3-way Cam Vernier 12/6
 3-way Ordinary .. 7/6
 2-way Panel .. 3/0
 3-way Panel .. 3/0
 Basket Holders .. 1/4

H.T.C. Valve Holders.
 Under Panel .. 1/9
 Over Panel .. 1/6
 Now Stocked.

THORPE K4 5 pin valve
 For Unidyne Circuit
 Post Free 17/6
 5-pin holder 1/3

VALVES.
 Myers Universal .. 11/-
 French "R" .. 7/6
 Dutch Detector .. 5/6
 Dutch "R" .. 5/11
 Metal .06 .. 13/11
 Radio Micro .06 .. 13/11
 Marconi, Ediswan, B. T. H., Cossor, Mullard, etc.

BRITISH VALVES.
 All bright emitters.
 11/-
 D.E.R. all makes 18/06, all makes 21/06, power valves
 22/6 to 30/06
ASPER MAKERS' LISTS
 Valves posted buyer's risk.

WATES MICROSTAT
 New Improved Model
 Post Free. 2/9

HEADPHONES.

Reduced Prices.
 British B.T.H. .. 20/-
 Brandes' Matched Tone .. 20/-
 General Radio .. 20/-
 Brown's F Type .. 20/-
 Sterling's .. 22/6
 All 4,000 ohms.
 Highest quality finish.
 Post free U.K.

TELEFUNKEN.
 Adjustable, 4,000 ohms, only genuine when bearing No. EH 333 on each earpiece. These 'phones are lighter than a feather, and simply wonderful for reception. Post price U.K. 17/11 pair.

POLAR Variable Condensers.
 .001 .. 10/8
 .0005, .0003, .00025 10/6
 Micrometer .. 5/6
 2-way cam vernier 6/-
 Post free U.K.

STERLING Square Law, with Vernier.
 .001 .. 30/6
 .0005 .. 25/6
 .00025 .. 23/6
 Post free U.K.

"WONDER"
 Aerial Wire, 49 strands. Special Alloy Phosphor Bronze, for frame, indoor or outdoor. Non-corroding. 110 ft. 3/3. By post, 3/8.

"LISSEN."
 Lissen Minor .. 3/6
 Lissenstat .. 7/6
 Lissen Universal .. 10/6
 Push and Pull .. 2/9
 Do., 5 point .. 4/-
 Series Parallel .. 3/9
 Var. Grid Leak .. 2/6
 Anode Resistance .. 2/6
 See Transformers.

MIC-MET DETECTOR 6/-
 Post free U.K.

L.F. TRANSFORMERS.
 Eureka Concert Grand .. 30/-
 Eureka Second Stage .. 22/6
 Igranic Shrouded New Model .. 21/-
 Powquip, see illustrations.
 Lissen T1, for 1st stage .. 30/-
 Lissen T2, for 2nd stage or 3rd stage .. 25/-
 Lissen T3, Popular Model .. 18/6
 Formo Shrouded .. 18/6
 Formo Open Type .. 18/6
 Portland, Highly Recommended .. 32/6
 Wates Supra .. 15/-
 General Radio 83 .. 21/-
 Super Success (Black) .. 21/-
 "Royal" Transformer .. 20/-
 "Raymond" 1st stage 5-1 .. 12/6
 Raymond 2nd stage 3/1 .. 12/6

£50 REWARD

given if the
DR. NESPER
 PHONES SOLD HERE ARE NOT GENUINE! BEWARE OF FRAUDULENT IMITATIONS!!
 (Injunctions obtained.)
 Adjustable diaphragm, detachable receivers, double leather-covered head-springs, long flexible cords, nickel-plated parts. Very comfortable fitting to the head. Per Pair, 12/11 Post 3d. pair.

ACCUMULATORS FOR CALLERS ONLY at present.

Rheostat, with dial, extra value, 2/6
 Bretwood Valve-holder, 1/9
 Manchester "Powquip," 15/6
 Ormond 14/6
 Shrouded "Powquip," 18/-
 Standard "Powquip," 14/6
 "R.I." NEW MODEL IN SEALED BOX.
 Don't Buy Otherwise. Post 25/- Free

FERRANTI L.F. BETTER THAN THE BEST 17/6

IMPORTANT NOTICE
 TRADE COUNTER OPEN
 will oblige you with any lines in stock, less 20% on Proprietary articles. NO POST ORDERS

TRADE PANELS
 3-16th in.
 3x8.1/8 10x8.3/8
 7x5.1/8 12x9.5/8
 8x6.2/8 12x12.5/8
 9x6.2/9 14x10.5/9
PANELS DRILLED FREE WITH ORDERS
 OVER 20/0. Please send diagram.
PANELS DRILLED AND ENGRAVED FREE WITH ORDERS OVER £5.
 West End stockist of Edison Bell, Igranic, Goswell (quality), Polar, Jackson Bros. (J.B.), Marconi, Cossor, Mullard, Ediswan Valves, Sterling, B.T.H., McMichael's, Lissen, Dubilier, T.C.B., Finston parts.

K. RAYMOND
 27, LISLE STREET, LEICESTER SQUARE, W.C.2
 No responsibility accepted on post orders unless cheques and postal orders are crossed and made payable to the firm. Moneys sent must be registered

HOURS OF BUSINESS:
 DAILY - 9 to 7.45
 SUNDAY - 10 to 1
 Phone: GERRARD 4637



An Amplifier for the "Stay-Set" Crystal Receiver

By D. J. S. HARTT, B.Sc.

FOR those who obtain good signals on a crystal set from their local broadcasting station, and are desirous of making an addition to their set to enable them to operate a loud-speaker, a two-valve low-frequency amplifier embodying a stage of transformer coupled amplification, followed by a resistance-coupled stage, will give ample volume and good reproduction.

The amplifier seen in the photographs is of this type, and is uniform with the "Stay-set" crystal receiver described by the author last month. The instrument may, of course, be used with any type of crystal set, but one in which is used a crystal detector that will stay adjusted is to be recommended.

The Arrangement Used

The arrangement adopted consists of a vertical panel attached to a loose baseboard which carries a terminal strip at the back. The whole slides into the cabinet which, in the actual unit, is provided with a hinged lid, the lower part of the back of the cabinet being cut away to accommodate the terminal strip. When the amplifier is in use the valves are within the cabinet, and all battery connections are made from the rear. This

arrangement makes possible a simple panel layout. The terminals seen on the left of the panel are connected to the telephone terminals of the crystal set, while those on the right are for the loud-speaker, the positive lead (usually marked +, or distinguished by some red or other coloured marking on the braid) of which is connected to the lower terminal. The control

be seen that only one H.T.+ terminal is provided, and that three terminals for grid-bias battery connections are used. The order of the terminals on the terminal strip is the same, reading from left to right when looking at the back of the instrument, as is shown on the circuit diagram, reading downwards from H.T.+ . The value of the anode resistance R_4 may be

60,000 ohms if an ordinary general purpose valve is used as the first valve. If a valve of the D.E.5B type is used, however, this value may with advantage be increased to 100,000 ohms or more. The coupling condenser C_1 has a value of $\cdot 01\mu F$, while the value of the condenser C_2 across the loud-speaker will vary according to the type of loud-speaker used, the limits being around $\cdot 001$ to $\cdot 01\mu F$, a $\cdot 001\mu F$ being an average value. The clip-in type of condenser is used, so that different values may be substituted if required. You will notice that no fixed condenser is shunted across the primary winding T_1 of the transformer, and in many cases there will be no con-

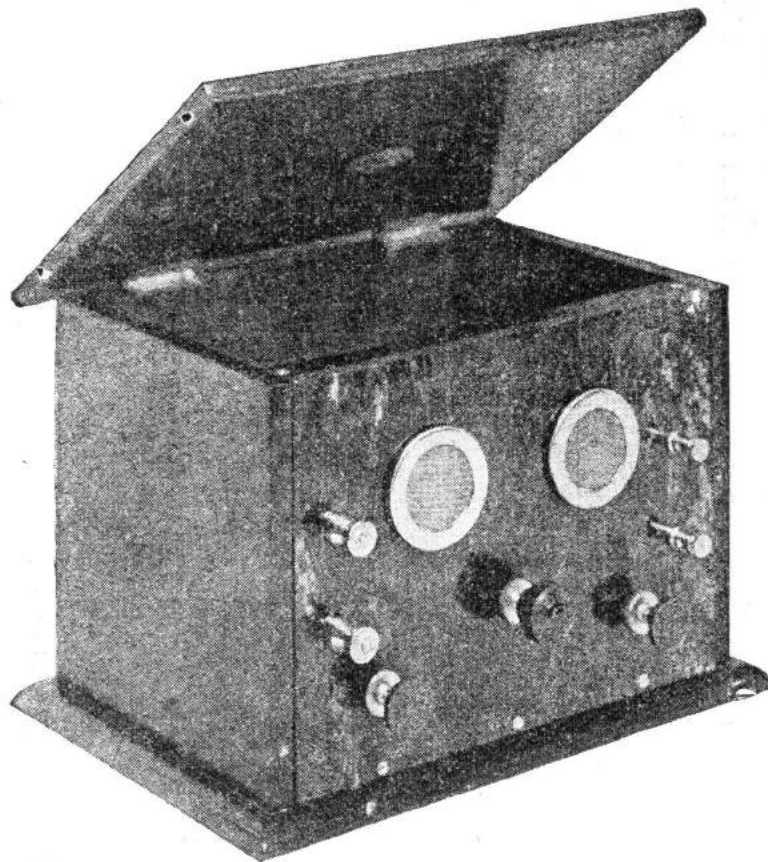

The neat appearance of the amplifier matches that of the crystal set it is designed to follow.

knobs for the rheostats are seen on the lower part of the panel, while that in the centre controls a variable grid leak.

From the circuit diagram it will

denser across the telephone terminals of your crystal set. In practice the use of a condenser in this position is justified only if results are thereby improved, but

A view of the set removed from the cabinet.

Note the short wiring.

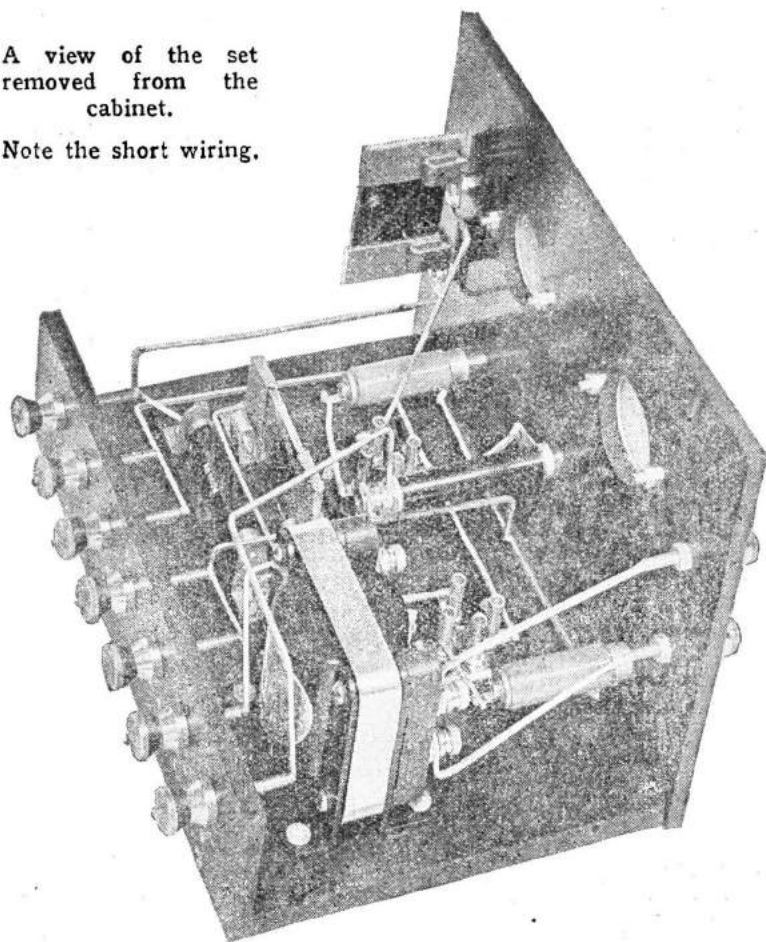

the photographs was made by the Carrington Mfg. Co.

The first step in the construction is to mark out the panel on the

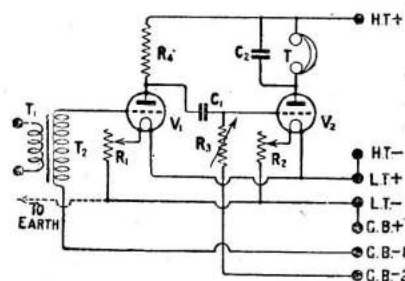

The circuit arrangement.

back and drill the necessary holes according to the drilling diagram. The large holes for the valve windows may be made with the aid of an ordinary fret-saw or an expanding bit, if this is available. Next mark out and drill the terminal strip, and then prepare the smaller ebonite strip for mounting the clips to hold the anode resistance and the coupling condenser; $\frac{1}{2}$ -in. countersunk head 2 B.A. screws are used for this purpose, and the holes are well countersunk on the underneath side. Holes are provided at the ends of this smaller strip for screwing to the baseboard. If desired, the anode resistance and the coupling condenser may be purchased already mounted on ebonite strips, in which case the $\frac{1}{4}$ -in. by $\frac{1}{4}$ -in. strip of ebonite will not be required.

in general it may be omitted with no apparent difference in the results.

Now with regard to the materials required, here is a list of those actually used. If in any case another make of component is selected, the layout may have to be slightly altered, if the size and shape are very different.

- 1 Ebonite panel, 8 in. by 6 in. by $\frac{1}{4}$ in. (Peter Curtis, mahogany finish).
- 1 Strip of ebonite, 8 in. by 2 in. by $\frac{1}{4}$ in.
- 1 Ditto, $4\frac{1}{4}$ in. by $1\frac{1}{4}$ in. by $\frac{1}{4}$ in.
- 2 Valve windows (Aermonic, nickel-plated).
- 1 Variable grid leak (Bretwood).
- 2 Filament resistances (Lissenstat Minor).
- 2 Valve holders (Burne-Jones, for baseboard mounting).
- 1 Low-frequency transformer (Royal, Rothermel, Ltd.).
- 1 Anode resistance, 60,000 ohms, with clips (McMichael).
- 1 $0.01\mu\text{F}$ fixed condenser, with clips and an extra set of clips (McMichael).
- 9 W.O. type terminals and 2 phone-type terminals, nickel-plated.

Square section tinned copper wire, and one packet R.P. panel transfers.

In addition, a suitable cabinet will be required; that shown in

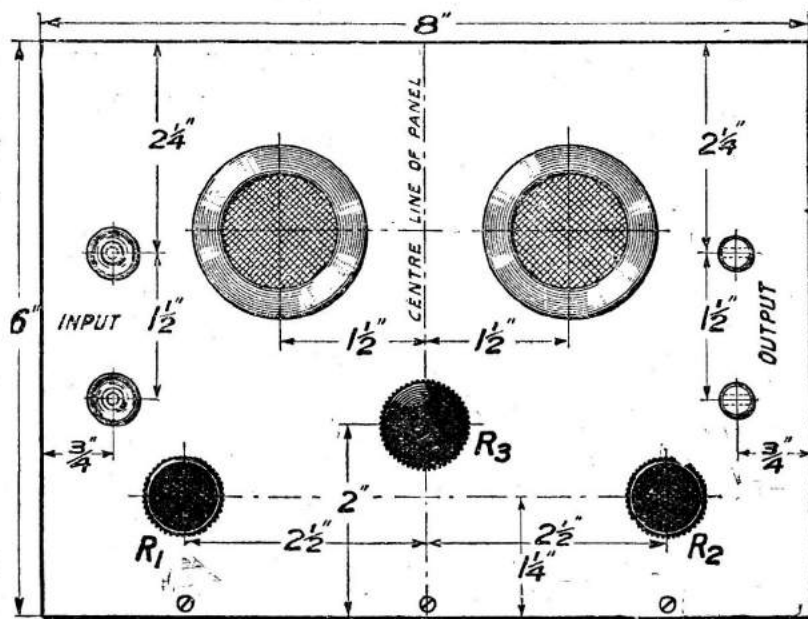

This half-size drawing shows how the panel is to be drilled.

At this stage mount the components on the panel, fix the terminals on the terminal strip, and screw down the transformer, valve holders, and anode resistance and coupling condenser unit to the baseboard. The disposition of these latter components may be gathered from the wiring diagram and the photographs. The clips for the condenser across the output are attached to the shanks of the terminals by a second nut screwed down tightly, the shanks being cut off level with the tops of these nuts.

The wiring is a simple matter if carried out as follows, all connections being carefully soldered:— First, screw the terminal strip to the back of the baseboard; then make the connections IS of transformer to terminal GB-1, filament to H.T. -to I.T.+, OS to grid of first valve, plate of first valve to anode resistance to coupling condenser, other side of coupling condenser to grid of second valve to grid leak. These connections may be followed from the wiring diagram. Next make the connection between those soldering lugs on the filament resistances which are nearest the panel; the

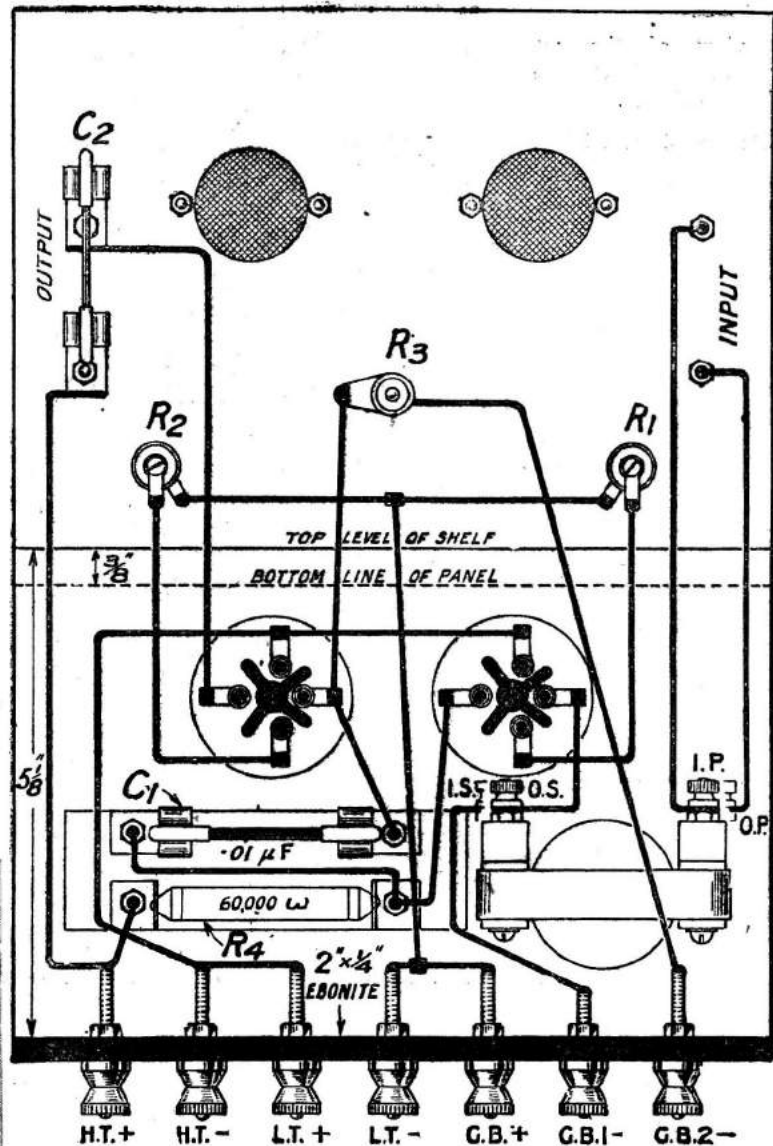

This drawing shows the wiring of the amplifier.

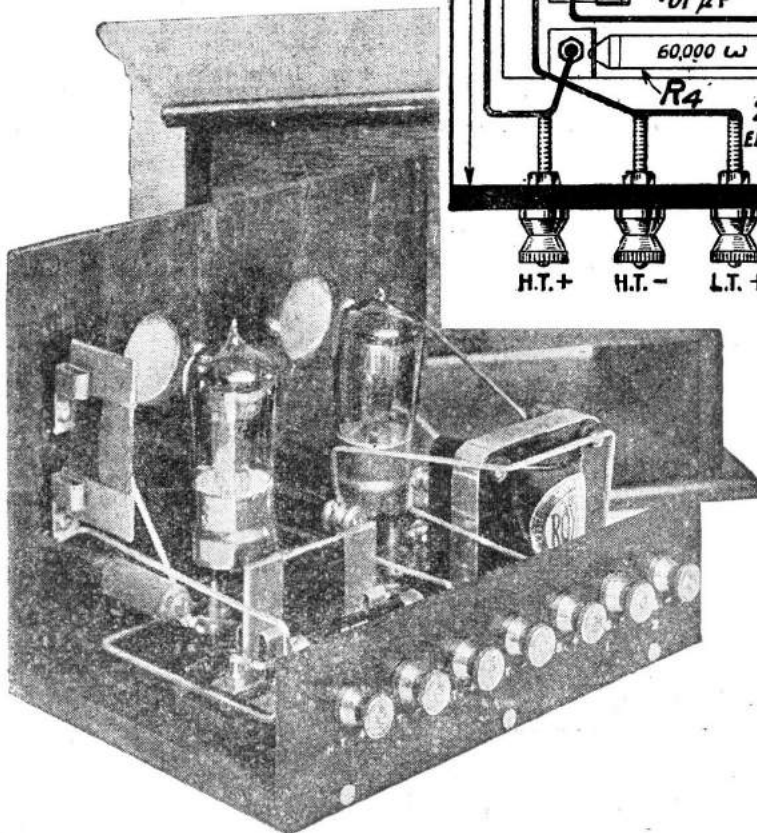

Another view of the set removed from the cabinet, showing how the latter is cut away to receive the terminal strip.

latter is then screwed to the baseboard by three countersunk screws, and the remainder of the connection made, finally checking the whole of the wiring against the diagram.

For a preliminary test on the amplifier join the three grid-bias terminals by a wire and connect up the accumulator. Ascertain that the valves light up correctly, then connect the two terminals on the left of the panel to the telephone terminals of your crystal set, which has previously been adjusted to give the best results on the local station. A wire is then taken from the L.T.- terminal to the earth terminal of the crystal set, and the H.T. battery and loud-speaker connected.

(Continued on page 551).

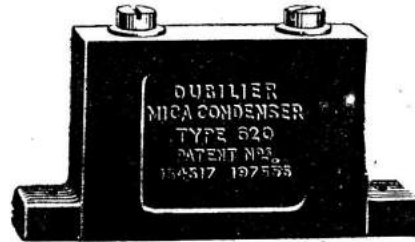

The Question—

There are thousands, of course, but two of them are very common indeed. They are—

- (1) Shall I pay a higher price and make sure of getting good components in my set, or shall I economise and take a chance?
- (2) My set is not giving very good results. Of course I have not got quite the best condensers. Is it worth while changing them?

There is a common-sense answer—that if a slightly higher price will secure a better article, it is nearly always worth while paying it. Obviously that remark applies most particularly to a wireless set.

The answer to the above question is, therefore, contained in two words—

Specify Dubilier.

TYPE 620.

This is an entirely new Mica Condenser for all purposes in connection with wireless receiving apparatus. It is of improved design and construction, and is arranged with screw-terminals to avoid soldering.

*0001 to *0006 mfd. ...	3/-	*01 mfd. ...	4/-
*001 " *009 mfd. ...	3/6	(about) *011 to *015 mfd. ...	4/6

Ducon Works,
Victoria Road,
North Acton,
London, W.3.

Telephone :
Chiswick 2241-2-3.

Telegrams :
Hivolcon, Phone,
London.

FALLON SQUARE LAW CONDENSER

Features

One hole fixing, tag connections, heavy aluminium top and bottom plates.

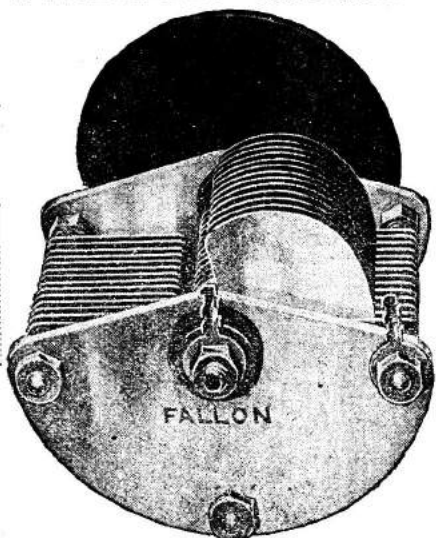

Features

Metal to metal adjustable bearings, stout, well-cut aluminium vanes. Complete as illustrated.

The New Fallon Square Law Condenser is absolutely the last word in perfect condenser construction. Extremely handsome appearance, all parts being heavily plated; .068 spacing (the closest possible). In the new model the overall length of the .001 condenser is only 4 1/2 in. as against 5 1/2 in. in the old model, and by a new idea in spacing washers, rigidity of construction, never before achieved in any make of condenser, has been obtained.

SQUARE LAW TYPE (As illustrated.)	
Price.	Price.
.001 .. 9/6	.00025 .. 6/9
.0005 .. 8/6	.0002 .. 6/-
.0003 .. 7/-	Vernier, 3 or 5/4/6

STANDARD TYPE With Ordinary Vanes.	
Price.	Price.
.001 .. 8/9	.00025 .. 6/-
.0005 .. 7/-	.0002 .. 5/6
.0003 .. 6/6	Vernier, 3 or 5/4/6

FALLON FIXED CONDENSERS



—improve results in all Sets. Made of the highest quality mica and copper foil: each one tested and guaranteed. FALLON Fixed Condensers are right up to FALLON standard. Fitted with soldering tags and nuts for making clean connections. **British Reputation.**—Your condensers are not FALLON'S unless the name FALLON appears on same.

FALLON Fixed Condensers. Capacities up to .001, 1/3 each. Capacities up to .004, 2/- each.

Fixed condenser and Grid Leak COMBINED. (As illustrated) 2 or 3 megohms. 2/6 each.

FALLON'S —The Premier VARIOMETER

Inside winding suitable for broadcast reception on any P.M.G. Aerial, extraordinary close coupling ensuring large tuning range. Inductance, the highest possible—9.5 to 1. Metal feet can be adjusted to four different positions. As used in the Single Valve receiver for all wave-lengths, described and illustrated in *Modern Wireless*, July issue.

PRICE 10/-
Postage 6d.

All Post Orders, Correspondence and Applications for Trade Terms to:

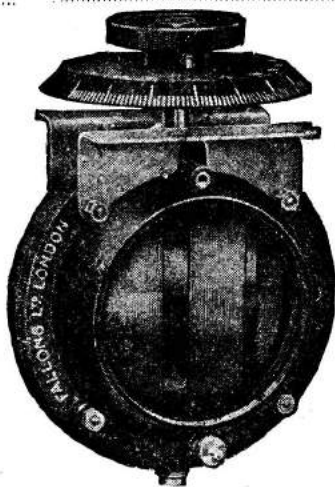

FALLON CONDENSER COMPANY, LTD.

White Ribbon Works, Broad Lane, Tottenham, N.15

BRANCHES: 120, Wellington Street, Glasgow.
3, King's Street West, Deansgate, Manchester.

Barclays 814

“Ah! So that's the secret of your DX results!”

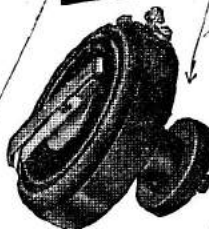
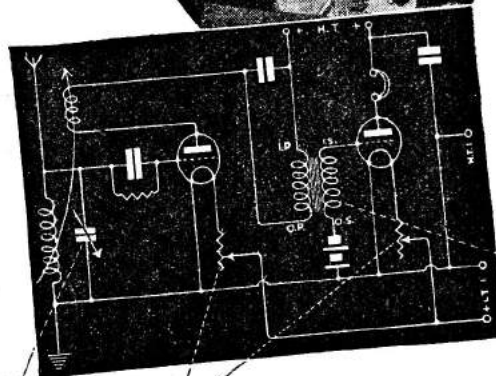

This patent dual rheostat allows the quick change from dull to bright emitters, and vice-versa, desired by experimenters. 6-60 ohms. 8/6



Ericsson intervalve transformers get the last ounce out of your valves without distortion. Ratios 1-2, 1-4, 17/6 each.

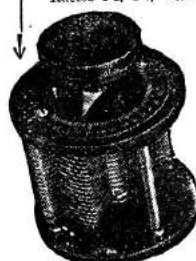

Our tested condensers are wonderfully accurate and low in losses. Stout Vanes, extra narrow spacing. .001 .. 12/6 .0005 .. 10/6

Look behind the DX fan's panels—in seven cases out of ten you'll find Ericsson tested components—transformers, condensers, rheostats, grid leaks, etc., etc.

There's good reason—all our components are made to a definite end with vernier precision. Our condensers are dead accurate, our transformers amplify in perfect purity and strength, our grid leaks regulate grid potential to the correct value every time.

Build that new circuit with Ericsson tested parts—and get that DX feeling.



In the days when faint Morse from big distances was all that was "on the air," the Navy adopted Ericsson (British) Phones as standard. To-day they all resistances are the DX phones—found on every experimenter's bench.

22/6

Write to-day for free lists and further information (or apply nearest high-class dealer).

The British L.M. Ericsson Mfg. Co., Ltd.
67-73, KINGSWAY
LONDON, W.C.2

Ericsson

TESTED PARTS

Buy British Goods Only



How It Works

THE CONDENSER

By R. W. HALLOWS, M.A., Staff Editor

IN the wireless set we use condensers for three main purposes. The variable condenser in conjunction with an inductance coil gives us a circuit which can be tuned to a band of wavelengths depending upon the size of the coil and the capacity of the condenser. A fixed condenser may be employed as a by pass for oscillating currents to whose passage it offers very little hindrance if its capacity is large enough. A condenser of this kind is used across

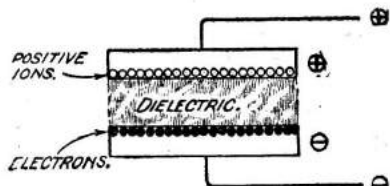

Fig. 1.—What happens in a charged condenser.

the telephones, interval transformer, or in shunt with the high-tension battery. The condenser may also be used as a barrier to direct current. Current of this kind is unable to pass through a condenser. The grid condenser serves both as a barrier to direct current from the high-tension battery in a tuned anode circuit and as a by-pass for oscillating impulses.

Metal Plates

A condenser consists of two metal plates separated by some non-conducting material which is called the dielectric. The best of all dielectrics is air for the capacity obtained when it is used is not

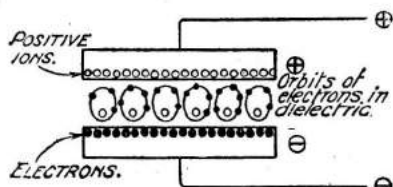

Fig. 2.—The state of strain.

liable to any great variations, losses through leakage are very small indeed, and if by any chance the dielectric is punctured by

sparking between the plates, it repairs itself instantly. Mica has a higher dielectric constant than air. That is to say, if you have two sets of plates of equal size, the first with a mica dielectric and the second with an air dielectric, the distance between the plates being the same in both cases, the first condenser will have a capacity of about eight times that of the other. Other dielectrics sometimes used are ebonite, which gives rather more than twice the capacity of an air dielectric of the same thickness, glass, which averages about six times the capacity of air, and waxed paper, whose dielectric constant is rather more than double that of air. None of these is so constant or so efficient as air. A liquid dielectric in the form of mineral oil is sometimes used. The dielectric coefficient of some oils is a little more than double that of air.

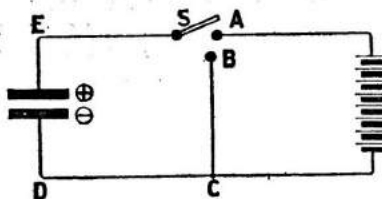

Fig. 3.—Illustrating how a battery can be used to charge a condenser.

Fig. 1 shows what happens in a charged condenser. On the positive plate there is an excess of positive ions, or of atoms which are deficient of one electron. These crowd on to the surface of the plate that is opposite the negative plate. On the negative plate there is an excess of electrons, which again crowd to the surface. Positive ions and electrons attract each other with a force that is many millions of times stronger than gravity. The dielectric is a substance which contains practically no detachable electrons; it is therefore impossible for current to pass through it unless the pressure is so enormous that it breaks down. What happens is that the orbits of the electrons in the dielectric become strained, as shown in

Fig. 2. The positive nucleus of each atom is pulled by the attraction of the atoms towards the negative plate, whilst the electrons of the atom are drawn by the pull of

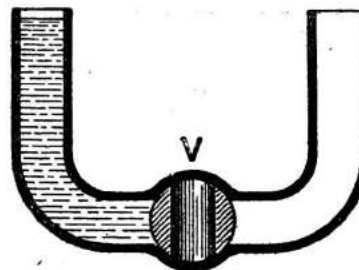

Fig. 4.—A water analogy.

the positive ions towards the positive plate. The more we charge up the condenser, the greater will the strain on the orbits be, and if we go on charging it indefinitely a point will be reached at which the dielectric can no longer stand the strain and breaks down. When this happens electrons in the dielectric are wrenched out of their orbits and make for the positive plate. They are replaced by electrons from the negative plate, and the result is that a current flows through the punctured dielectric. To break down an air dielectric one millimetre in thickness a voltage of 4,300 is required. Mica of the

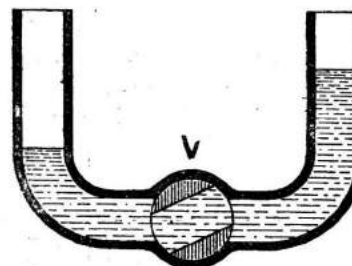

Fig. 5.—Overrunning.

same thickness will stand a pressure of 60,000 volts before giving way.

Holding the Charge

If the charge is not great enough to break down the dielectric the condenser will store up the energy put into it for a long time. A good

condenser will remain charged for many hours, or even days, but the charge will gradually leak away. Suppose now that we wire up a circuit such as that shown in Fig. 3. If we place the switch arm S on the contact point A the battery will charge up the condenser. This having been done, we will throw the switch over until the arm rests upon the contact point B. The condenser can now discharge itself through the circuit B, C, D, E. That is to say, electrons on the negative plate will rush round the circuit to combine with the positive atoms on the upper plate so as to neutralise them. Actually the discharge of a condenser is not quite

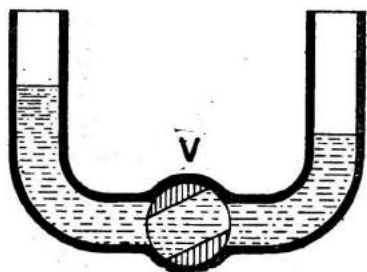

Fig. 6.—A back swing.

so simple as this. To understand it fully we may take an analogy from water. Fig. 4 shows a U-shaped glass tube provided with a valve V between the two arms.

A Hydraulic Analogy

If we fill the left-hand arm nearly to the top with water, leaving the right-hand arm empty, the tube is in precisely the same state as a charged condenser. The pressure of the water is acting upon the valve, which plays just the same part as the dielectric of the condenser. The water tries to pass into the right-hand arm, so that it may adjust itself to an equal height in both arms. Energy is stored up in the arrangement by means of the valve. Suppose now

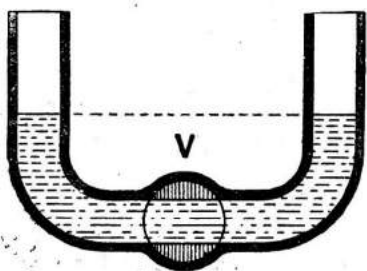

Fig. 7.—Neutralisation.

that we open the valve suddenly, what will happen? The water will rush with such force through it that after a moment the position

will be very much what is shown in Fig. 5. The right-hand arm now has water whose level is higher than that in the left. The strain is now in the opposite direction, and the water swings back again, not going so far this time, until it reaches the position shown in

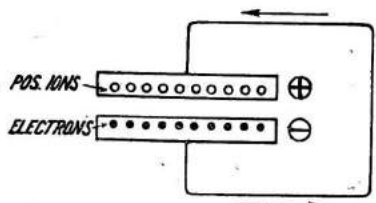

Fig. 8.—A numerical analogy.

Fig. 6. And so it continues to swing to and fro until, finally, it comes to rest in the position shown in Fig. 7, the level in both arms being the same. The condenser during discharge overdoes things in precisely the same way. This is shown diagrammatically in succeeding figures.

Surplus Electrons

Let us imagine that we start with ten surplus positive ions on the upper plate and ten surplus electrons on the lower—actually of course the numbers will be millions of times greater, but smaller figures will serve very well to illustrate what happens. Directly the switch in Fig. 3 is thrown over to contact B, the state of affairs is as shown in Fig. 8. Electrons rush round the circuit to neutralise

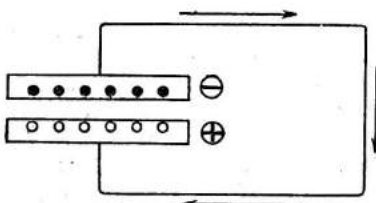

Fig. 9.—The second stage.

the positive ions. So great is the rush that far more than ten leave the plate, and at the end of a brief instant the position is that there are, let us say, five surplus positive atoms on the lower. There is now another dash of electrons in the opposite direction, as shown in Fig. 9. During this things are again slightly overdone, and the result is to leave, say, three surplus positive ions on the top plate and three extra electrons on the lower, as in Fig. 10. And so the discharge goes on by swings in alternate directions until, finally, the electrons have just balanced the

positive ions and there is now no pressure at all between the plates.

The Spring

It may occur to you that you have seen a very similar phenomenon in mechanical things. You have noticed, for example, how a spring comes to rest when it has been extended and released. Fig. 11 shows what happens in such a case. At A we have a coil spring fixed at its upper end and under no strain. At B the spring has been pulled down until it is about double its original length. At C the spring has been released, and has shot back to something much shorter than it was originally. At D it has recoiled, and is now rather longer than it was at first, though not so long as it was at B. The spring continues to extend and

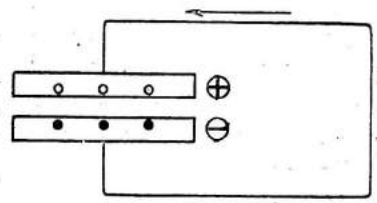

Fig. 10.—A further swing.

contract for some time before it finally comes to rest.

A Good Comparison

This analogy is a very good one, for a condenser is electrically just what a spring is mechanically. A spring either compressed or extended is storing up energy which will be given back when it is released. In the same way a charged condenser stores up energy, giving it back when a path is

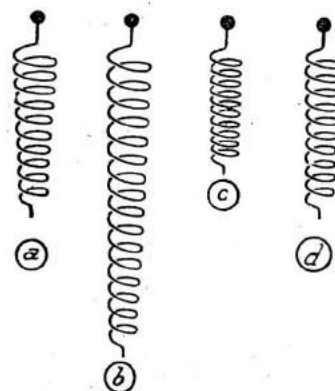

Fig. 11.—The spring analogy.

provided for it to discharge through.

Inductance

And we can carry the analogy much further if we fix in our

Be Certain
of
Good Results



M.H. Components of proved design, are those I purchase every time.



M.H. DOUBLE FILAMENT RHEOSTAT.

For use with either Dull Emitter or Bright Emitter valves alternatively. Similar to the ordinary M.H. type Filament Rheostat and provided with an off position. The dial is engraved RED on the Bright Emitter segment and WHITE on the Dull Emitter segment 7/8.



M.H. FIXED CONDENSER.

Standard M.H. interchangeable fixed condenser unit. 0.0001 μ F to 0.001 μ F, 1/9 each. 0.002 μ F to 0.01 μ F 2/3 each.

Each supplied with two clips.



M.H. H.F. PLUG-IN TRANSFORMERS

A series of H.F. Plug-in Transformers in six ranges of wavelength. They are made of highly polished non-loss ebonite. The windings are carried in staggered slots, well protected, ensuring low self-capacity and high efficiency. Each and every transformer is tested to a standard oscillator, and any not coming within very narrow limits are rejected. Perfect matching is thus ensured.

No. 00	80 to 150 metres	10/-
No. 0	150 to 300 metres	10/-
No. 1	300 to 600 metres	10/-
No. 2	550 to 1,200 metres	10/-
No. 3	1,100 to 3,000 metres	10/-
No. 4	2,500 to 7,000 metres	10/-

The Complete Set in case, Nos. 00-4 55/-

A.G. Neutrodyne Unit (Broadcast Wavelength) ... each 10/-

Any number of each Transformer can be supplied matched at NO extra charge if requested at the time of ordering.

L.M. MICHAEL LTD

Manufacturers of Wireless and Scientific Apparatus
179, STRAND, LONDON, W.C.2

Barclays 820

BUILDING A STAGE OF H.F.

Builders of receivers utilising one or more H.F. Stages should not lose sight of the rule governing the function of the rectifier. Simply, half the power at the detector and its output is reduced four times; twice the power at the detector gives an output four times greater. Your H.F. Stages should hand on maximum energy. If you employ H.T.C. Low Capacity Valve Holders the maximum energy will reach the rectifier.

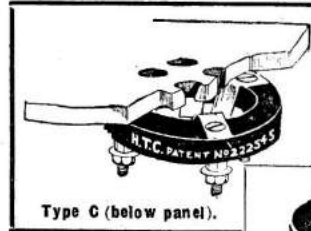

Type C (below panel).

The old type valve holder with sockets embedded in a moulding of doubtful insulating properties is the cause of poor H.F. Amplification. Capacity effects at the valve rob your receiver of range, power and quality.

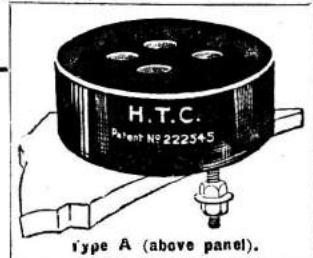

Type A (above panel).

Throw away the ordinary type of valve holder and try the difference the H.T.C. Low Capacity Valve Holder makes. It will take you one evening to observe the difference. Those hitherto elusive stations will come in. On the local station, maybe, less reaction will be required. Such a demonstration of efficiency conveys its own conviction.

In multi-stage H.F. work high capacity at the valve may completely nullify H.F. amplification.

If your receivers employ the Plug-in H.F. Transformer you can only expect efficient H.F. Amplification by mounting them in the H.T.C. Valve Holder.

Your dealer may try to persuade you that some thing in stock is as good. H.T.C. Products are unrivalled for their electrical performance. If your dealer cannot supply, send direct to:-

H.T.C. ELECTRICAL CO. LTD.
2 & 2a, Boundaries Rd., Balham, S.W.12
Trade Enquiries Inv't d. Phone: Battersea 374

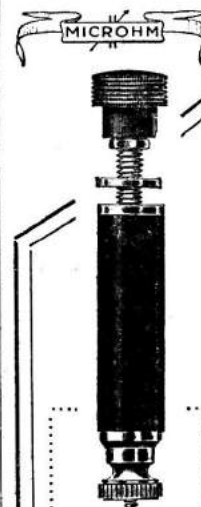

PRICE 2/6

Inv Pat No. 19426/24.

The Value of Fine Tuning

is being more and more appreciated particularly when one buys the Microhm

Vernier Type Variable Condenser

There are no less than 24 turns to give the "MICROHM" fine tuning adjustment.

Suitable for use as stabiliser in "NEUTRODYNE" circuits.

May be used in parallel with an ordinary condenser, giving exceptionally fine tuning adjustment.

Maximum capacity .0001 mfd.
Minimum negligible.
One 1/8" hole fixing.

A Precision instrument designed on scientific lines.



MICROHM ENGINEERING CO.,
Varsity Works, College St., London, E.9. Phone: Clissold 2887

Barclays 827

Want to build a better set ? Use components marked "Burndept"

WHEN you use Burndept components in the instruments you build, you will notice a distinct improvement in the tone and volume of the signals received. This is because Burndept components are designed with that care which is the outcome of long experience, and are manufactured skilfully from good materials. Moreover, the efficiency of our apparatus is covered by a twelve-month guarantee. The satisfaction of every purchaser is definitely assured.



COILS

Set of 4 Extra Short Wave Coils, One A, Two B, One C (80-1 0 metres) 16s.

Set of 4 Concert Coils, S1, S2, S3, S4 (150-800 metres) 16s.

Set of 9 Coils, S5 to 1,000 (750-20,000 metres) £3 16s. 6d.

Write for Publication No 44, which gives details of the wave-length range of Burndept Coils and prices of single Coils

CONDENSERS

For Panel Mounting, complete with Dial, Knob, Screws and Drilling Template.

No. 416. Capacity .0005 mfd., £1 10s.

No. 417. Capacity .001 mfd., £1 15s.

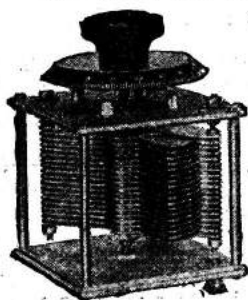

Burndept Coils cover all wave-lengths from 80 to 25,000 metres. They have extremely low self-capacity and high-frequency resistance, and therefore are particularly suitable for short-wave reception. The spring socket fittings are non-reversible.

Burndept Standard Condensers are a remarkable approach to the theoretically perfect—they absorb only 0.05 per cent. of the power applied. The patented bearings ensure perfect contact and give a very smooth movement. Metal covers (not shown in the illustration), which eliminate hand-capacity effects and keep out dust, are fitted.

Burndept Transformers are completely enclosed in a neat steel casing which protects the coil from damage and, by reducing the external magnetic field, enables them to be placed quite close together without causing "howling." They have no "resonance peaks" and give even amplification of the notes of the whole musical scale.

Write for a free copy of the Burndept Catalogue, an 84-page illustrated publication, which gives full particulars and prices of the entire Burndept range



BURNDDEPT LTD., Aldine House, Bedford Street, Strand, London, W.C.2

Telephone: Gerrard 9072. Telegrams: "Burndept, Westrand, London."
NEW BRANCH: Winchester House, Victoria Square, BIRMINGHAM.

LEEDS: 12 Basinghall Street (near City Square).

CARDIFF: 67 Queen St.; NORTHAMPTON: 10, The Drapery

Burndept Components are guaranteed for 12 months; any that have defects in material or workmanship will be replaced or repaired free.



TRANSFORMERS

No. 226. High Ratio Intervalve Transformer (4-1). Primarily intended for use after the Detector for the first stage of amplification. The best general purpose transformer, £1 4s.

No. 333. Low Ratio Intervalve Transformer (2-6-1). For second and subsequent stages of amplification, and for all stages of power amplification. Specially suited to DE5 and LS5 valves, £1 4s.

No. 207. Loud Speaker Output Transformer For insertion in the plate circuit of the last valve for the operation of 120ohm loud speakers, £1 4s.

Purchase "BURNDDEPT" by its name — substitutes are not the same

minds that inductance is the electrical equivalent of weight. This we will explain more fully in a future issue; it will suffice now just to bear the fact in mind.

Now let us take a very homely illustration. In your young days you enjoyed, no doubt, the fascinating though forbidden pastime of bouncing upon a spring mattress, or, if you have never done that, you have seen at a music-hall the comic antics of a clown who leaps on to what looks like an enormous bed and bounces until he is almost out of sight. Now, the more stiff the mattress the more rapid are the bounds. That is to say, the more you increase the tension the greater is the frequency. In a condenser this is increased by reducing the capacity. Hence when we turn a variable condenser, say, from 25 degrees to 50, we lessen the springiness and so effect a decrease in the frequency, or an increase in the wavelength. This is how tuning is done in the wireless set. Fig. 12 shows diagrammatically the way in which the variable condenser works. At A we have two plates directly opposite one another so that each presents the largest possible amount of surface area to the other. In this case the capacity

is at its maximum. At B the plates have been moved so that each now presents to the other only one-half of its total area. The capacity between the two plates is now halved. At C the two plates are entirely out of mesh, no portion of one being opposite any portion of the other.

No Real Zero

The capacity is now theoretically zero, though actually in a

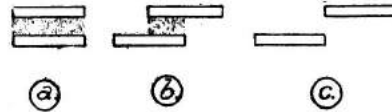

Fig. 12.—Effect of overlapping plates.

variable condenser it is impossible to reach anything like this value at the minimum setting. In a badly designed condenser the minimum capacity when the moving plates are completely out of mesh with the fixed may be as high as 10 per cent. of the maximum. Well-designed instruments may have a minimum capacity less than 1 per cent. of that obtained when the two sets of plates are fully meshed.

An Amplifier for the "Stay-Set" Crystal Receiver

(Concluded from page 544)

Adjust the rheostats to give the best results, then remove the wire connecting the grid-bias terminals and connect up a small grid battery tapped in 1½-volt steps. Keep the positive wander-plug fixed, and determine the best positions for each of the others. The variable grid leak should be adjusted near its minimum setting, that is, screwed fairly well in.

With regard to the valves used, quite good results may be obtained with ordinary general-purpose bright or dull emitter valves and about 100 volts H.T., but a better arrangement is to use for the first valve one of the D.E.5B type and a small power valve as the last, with an H.T. voltage within the limits given by the makers.

When this amplifier is connected to the crystal set referred to previously, a loud-speaker is worked with good volume and pleasing quality, the distance from 21.0 being about 8 miles, and a good outdoor aerial being used.

forget the extra H.F. Stage

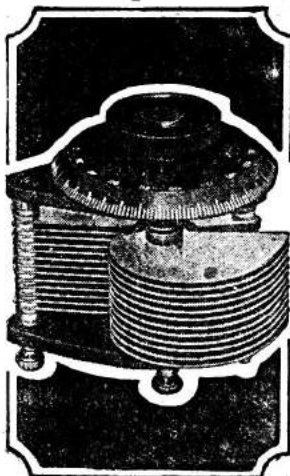

by a very simple expedient—incorporate J.B. Condensers. It takes but half an eye to observe that there is a distinct supremacy of the J.B. over any other make similarly priced. Dissect one at your dealers; examine it in minute detail and we know that you will choose the J.B. These are the expert's choice, and yours too if your judgment is good.

By fitting J.B. Instruments you can forget that extra stage of H.F.—for J.B. Condensers are low-loss. They pass on maximum energy and give you the utmost tuning efficiency. Remember, your dealer sells the J.B.—a guaranteed condenser.

SQUARE LAW.			
001	9.6	00025	6.9
00075	9-	0002	5.6
0005	8-	0001	5.3
0003	6.9	Vernier	4.6
STANDARD.			
001	8.6	00025	5.9
00075	8-	0002	5-
0005	7-	0001	4.9
0003	5.9	Vernier	4.6

J.B. Instruments are obtainable throughout the world. If you have any difficulty to obtain them, send direct to the Manufacturers. Post, one, 6d.; Two, 9d.; Three, 1/-.

JACKSON BROS.
 18, POLAND ST - OXFORD ST
 LONDON - W.1
 (First Floor)
 Telephone: GERRARD 7414

Barclays 808

FOR EVERY WIRELESS FIXTURE

RAWLPLUG WIRELESS OUTFIT

To fix cleats and stays for your aerial into any kind of wall, to fix brackets for your set or loud speaker, to carry wires or phone extension leads round walls, to make every fixture indoors or outdoors, you need the Rawlplug

Wireless Outfit. With its aid you can easily and permanently fix aerials, earth wires, battery shelves, switches, etc., to stone, brick, concrete, or plaster. Although designed for radio work, this Wireless Outfit has a hundred other uses about the house.

CONTENTS:

- 25 No. 14 Rawlplugs, 1½" & 1" 16ths.
- 25 No. 8 " 1" & ¾"
- Rawlplug Toolholder. Rawlplug Jumping Bit No. 14. Rawlplug Jumping Bit No. 8 adapted to fit No. 14 holder. Ejector. A supply of Porcelain Screw Hooks, Screw Eyes, Countersunk Screws, Screw Eye for fixing Aerial, and full 6/- instructions

The RAWLPLUG Co., Ltd., London, S.W.7

From Ironmongers, Electricians & Wireless Dealers Everywhere

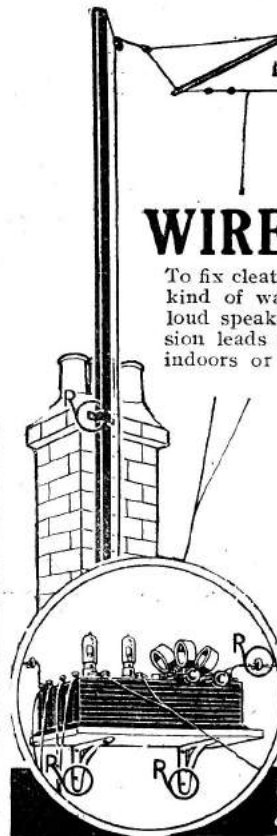

Full Power from Three Valves

(Concluded from page 498)

or 4,000 ohms and should be connected to the terminals marked "Tel." If the aerial is connected to the C.A.T. terminal a No. 50 coil or a 75 will be found to cover the whole broadcast band easily. If the aerial is connected to A, thus cutting out the constant aerial tuning condenser, a 25 or 35 will be needed for the lower band of wavelength, and a 35 or 50 for the upper. For Chelmsford and Radiola a No. 150 should be used. The reaction coil can generally be made one size larger than the particular aerial tuning coil used at the moment, save when constant aerial tuning is used, when, as the set oscillates much more freely, a smaller reaction coil will be required.

Keep the Reaction Coil Away

A few minutes' manipulation of the variable condenser will show

you how this part of the apparatus works. It should be mentioned that preliminary tuning should be carried out with the reaction coil placed as nearly as possible at right angles to the aerial tuning coil. When satisfactory results are obtained, the reaction coil can be gradually brought towards the fixed aerial coil, to see whether an increase of signal strength is effected in this way. If so, well and good; if not, reverse the connections to this coil.

Control of Reaction

On another page you will find an article by Mr. C. P. Kendall on "Reaction—Its Use and Abuse," which will show you how to get the best from reaction control, and on other pages you will find some hints on tuning in a set. Both of these articles should be perused by the beginner before beginning work on this powerful set.

Results

As stated in the beginning of this article, excellent results have been obtained from the local station and from others in the British Isles. Birmingham and London were full loud-speaker strength at Wimbledon using an average aerial, and with careful adjustment American telephony has been brought in on favourable nights. Reports on results with this set will be particularly welcomed, as it is believed to be one which will suit a wide range of readers.

Wireless Weekly !

Commencing with the March 4 issue, full details of the programmes from Continental and American broadcasting stations for the ensuing week are appearing as a regular feature. Names of artistes, songs and music will be given

ORDER NOW !

END YOUR DETECTION TROUBLES WITH THE 'HOVIMO' CRYSTAL VALVE

Replaces old-fashioned fiddle-fumble cats-whiskers and permanent 'permanent' detectors

The "Hovimo" Crystal Valve is an entirely new invention. It replaces catswhiskers and ordinary "permanent" detectors, which are often as difficult to fit into the individual set as they are to release once adjusted—in short, *too* permanent detectors.

The "Hovimo" Crystal Valve is easily fitted into *any* set, and is equally excellent for crystal sets and for circuits employing crystal rectification, as well as for crystal loud speaker systems. No batteries are required.

The "Hovimo" Crystal Valve makes the frequently trying work of detection perfectly simple. Just a turn of a milled screw and in an instant you have the finest reception a crystal can give—uninterruptedly pure and bell-like tone, which continues even if you move the set.

EVERY ONE GUARANTEED.



HOVIMO CRYSTAL VALVE

BRITISH MAKE

3/6
From dealers or post free direct

The "Hovimo" Crystal Valve is an entirely new invention, and must not be confused with the Silicon-bornite or similar combinations.

C. MOLBACK, 27, High Holborn, London, W.C.1

Phone : Chancery 8391

YOUR H.T. IS O.K.



when you install
HOVIMO CONNECTORS

1/6 PER DOZ
From dealers or post free direct

Avoid soldering and cheapen cost of complete battery by from 25 per cent. to 50 per cent.; ensure perfect "silent" working; are everlasting, allow easy replacement of units, will take ordinary wander-plug, and make it possible to keep H.T. at equal voltage. British made.



C. MOLBACK,
27, High Holborn
London, W.C.1
Phone : Chancery
8391

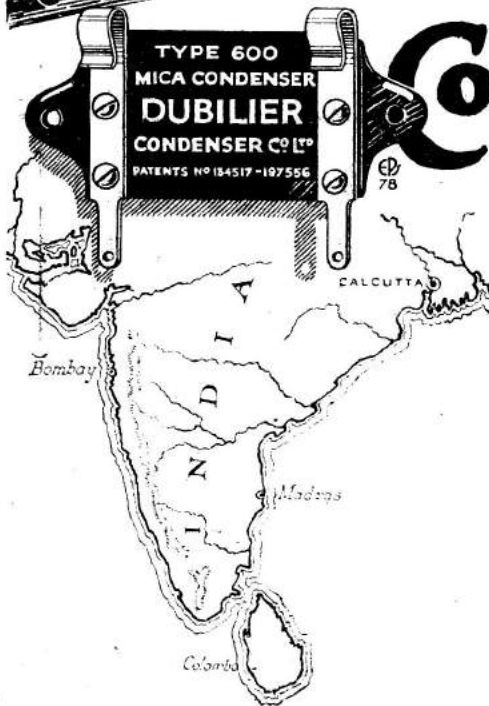

Concerning Mica

The "Dielectric" in all Dubilier fixed Condensers is of the best Ruby Mica, specially imported from the quarries of India. It has long been recognised that there are numerous reasons both mechanical and electrical, which account for the superiority of Mica over other dielectric materials employed in Fixed Condensers of small capacity.

Perhaps the best known of these are high insulation resistance and high dielectric strength which enable an exceedingly thin sheet of Mica to withstand very high voltages.

The Mica sheets in Dubilier Condensers measure only a few thousandths of an inch in thickness, yet each one of them before it can qualify for a place in a condenser has to withstand an alternating current pressure test of 5,000 Volts.

A Condenser made up of such sheets will resist, for example, the continued application of the full voltage from a High Tension Battery, whereas a condenser with an inferior dielectric may develop a short circuit—a fault which may possibly ruin a succession of H.T. Batteries before it is located.

Apart from insulation resistance, however, there are still very powerful arguments in favour of the Mica Condenser. The use of Mica enables Condensers losses (due to hysteresis, leakage, etc.), to be reduced to a minimum, especially as mica has a high "specific inductive capacity" so that the volume of the dielectric in a condenser in which losses can occur is reduced to a minimum.

From the above it will be seen that for every receiving circuit the best condenser is a Mica Condenser; and you will be assured of obtaining the best Mica Condenser if you

Specify Dubilier.



Advt. of the Dubilier Condenser Co., Ltd., Ducon Works, Victoria Road, North Acton, London, W.3. Telephone: Chiswick 2241-2-3.

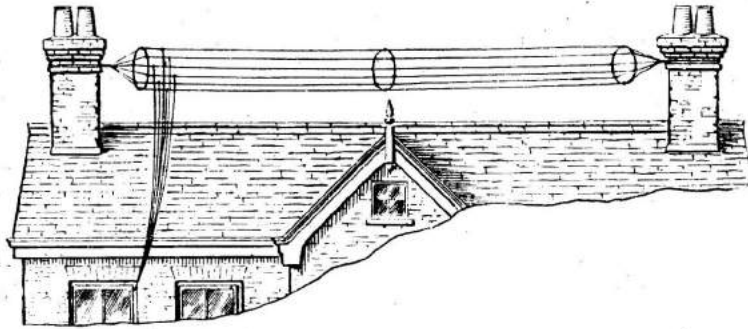

Fig. 1.—Showing how an outside aerial may be erected on the roof where space is limited.

AERIALS FOR AWKWARD PLACES

(2) Where the Garden is Small or Absent

By REDAX

MANY a man would like to fit a wireless receiving set in his house, but is deterred from so doing by the imagined impossibility of erecting a satisfactory aerial. Actually, there

garden. Take, for example, the case of a man who lives in a house in a crowded district where gardens are the exception rather than the rule. If he has access to the roof, then an aerial similar to that shown in Fig. 1 can be erected, the lead-in being taken to the room where the apparatus is in use in the manner indicated.

If it is not possible to erect an aerial on the roof between chimneys, then frequently, particularly if the broadcasting station is not far away, a good aerial can be obtained as shown in Fig. 3, where an insulated wire is taken on hooks from the window of the room in which the apparatus is situated as far along the house front, or back, as is practicable.

In very short gardens where expense is not the first consideration, a mast of more than the usual height can be erected with excellent results. Masts up to 50 ft. in height can be obtained at reasonable prices, and a number of firms will undertake to erect the mast and aerial complete for a small additional sum.

Fig. 2 shows a scheme which has

been proposed, but is not recommended, as it proves, on test, to be very inefficient. It consists in taking a wire from the room to the lower portion of a mast, from that to the top, and back to a hook on the house. Probably very much better results would be obtained by taking the aerial lead from the window to the insulator on a hook

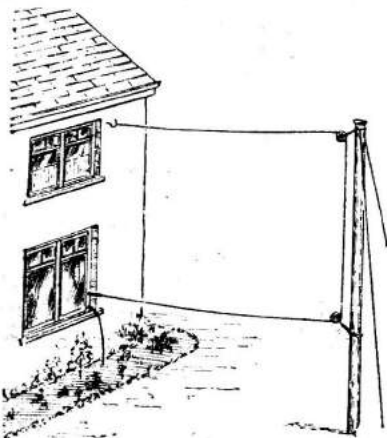

Fig. 2.—A poor arrangement.

are very few cases where an aerial cannot be erected, even when the would-be wireless enthusiast lives in a flat or a house without a

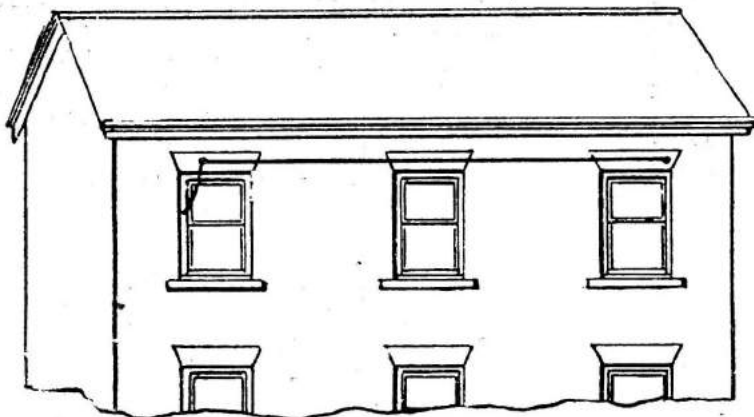

Fig. 3.—An insulated wire may be taken along the side of the house with good effect.

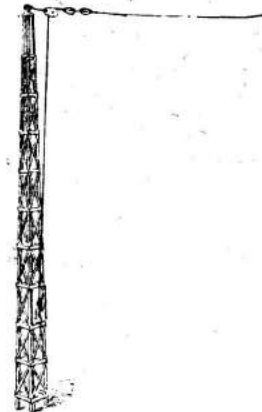

Fig. 4.—For the short garden a tall mast will help to compensate for lack of length.

above, and then to the top of a mast, in the more conventional manner.

Fig. 6 shows another arrangement, equally inefficient, and probably originating in the idea that so long as one erects a long wire its actual disposition does not much matter. Actually, in the illustration of Fig. 6, better results would be obtained with only half the amount of wire used. The remedy, of course, is to take the down lead from the upper portion, and cut out the wire running from the mast to the lower hook on the house.

Excellent results are obtainable from indoor aerials, particularly when the receiving set is fitted with one or more stages of high-

"UTILITY" VARIABLE SQUARE LAW CONDENSERS

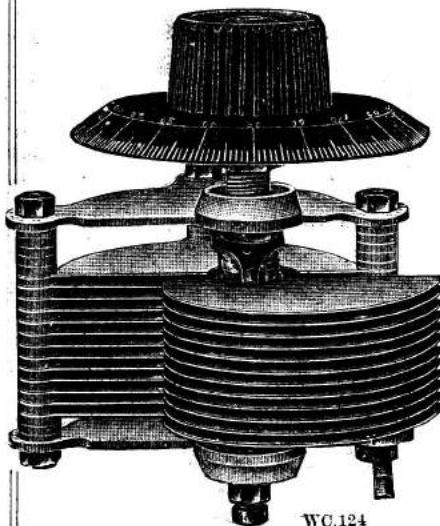

WC.124

at
same price
as our
ORDINARY

PRICES.

Ref. No.	Cap.	Price
WC.123	.001	12/6
WC.144	.00075	11/9
WC.124	.0005	10/6
WC.125	.0003	8/9
WC.145	.0002	7/9
WC.146	.0001	7/6
Vernier		2/6 extra

NO-CAPACITY

The "UTILITY" NO-CAPACITY SWITCH, as used in the constructional articles appearing in this journal.

Specially designed by electrical engineers to reduce the electrostatic capacity, this switch has proved to be exceptionally reliable in action and has self-cleaning contacts.

Size	Knob Type	Price
1 Pole Change over.	WC130	13/6
2 " " "	WC130	24/-
3 " " "	WC130	35/-
4 " " "	WC130	46/-
5 " " "	WC130	57/-
6 " " "	WC130	68/-

Size	Lever Type	Price
1 Pole Change over.	WC147	14/6
2 " " "	WC147	25/-
3 " " "	WC147	36/-
4 " " "	WC147	47/6
5 " " "	WC147	510/-
6 " " "	WC147	610/-

Nickel-plated, sixpence each extra.



WC. 147/6

SWITCHES

Manufactured by
WILKINS & WRIGHT LIMITED
UTILITY Works, Kenyon Street, Birmingham
Established 1867.

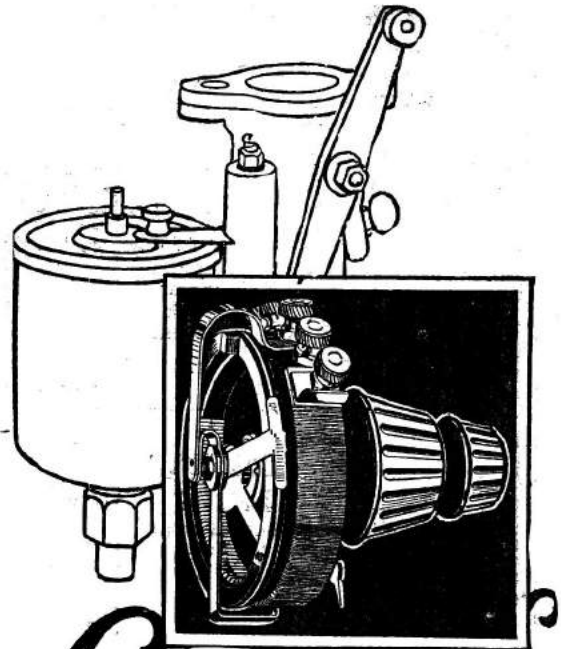

Control

FEW have not sat at the wheel and listened joyously to the soft purring of a perfect running engine susceptible to the slightest touch of the throttle. That ingenious piece of mechanism, the carburettor, plays its vital part, controlling the quantity of combustible mixture being sucked into the engine. Truly the essence of control.

So, you, at home in the evening, when lighting up the filament of the valve are also handling a piece of delicate controlling apparatus—the Rheostat. Bad filament control will bring you poor results. Good filament control gives you perfect reception.

Perfect control of the filament can only be obtained when you fit Royal Rheostats; these are alone worthy to give life to the delicate filament of a Radio Valve.

THE ROYAL CONTROL UNIT is a combined Vernier Rheostat and Potentiometer with independent action.
No. 607. 6 ohm Vernier Rheostat and 400 ohm potentiometer. Last Price 8/9
No. 610. 35 ohm Vernier Rheostat and 400 ohm potentiometer. Last Price 8/9

The Royal Control saves panel space.
Royal Rheostats Each
Royal Bakelite Rheostat 6 ohms 5/6
Royal " " 35 ohms 5/6
Royal " Vernier Rheostat 6 ohms 5/9
Royal " " 35 ohms 6/9
Royal " Potentiometer 400 ohms 6/9

ROYAL SUPER L.F. TRANSFORMER
The famous Royal Transformer as standardised by many set manufacturers and as incorporated in the Single Valve Reflex Receiver as described by Mr. Percy W. Harris in February issue of THE WIRELESS CONSTRUCTOR
Price £1 0 0.

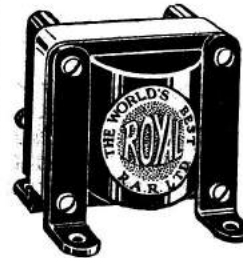

ROYAL

The Mark of Sovereign Quality

R. A. ROTHERMEL, LTD.

Manufacturers and Suppliers of
all kinds of Radio Apparatus

24 & 26, MADDOX STREET, LONDON, W.1

Telephones: Mayfair 578 and 579.

"COSMOS" Radio Specialities

The "Cosmos" Valves and Components displayed here are typical of the comprehensive range of efficient Radio parts sold under the name "Cosmos." Behind their manufacture and production stand the immense manufacturing facilities and long experience of the Metropolitan-Vickers Electrical Co., Ltd. This is the User's guarantee against dissatisfaction.



**"COSMOS"
D.E. 11
DULL EMITTER
VALVE
21/-**

THIS valve is designed for working off Dry Cells. It takes 0.25 amps. at 1.1 volt, and is a splendid Dull Emitter Valve for Loud Speaker Work. It will run off one Dry Cell, but we advise the use of TWO CELLS connected first in parallel and afterwards in series.

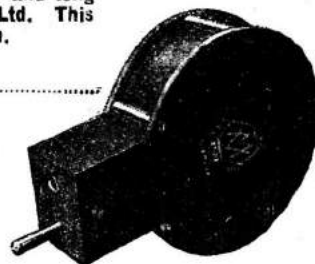

4/6 to 9/9

"COSMOS" STRIP INDUCTANCE COILS

(Patents applied for)

THESE coils are wound with "Cosmos" multi-wire strip, which consists of a number of Copper Wires embedded in prepared paper. The virtues of this unique construction include—Low Self Capacity—Minimum Resistance and Low H.F. Resistance resulting in exceptionally strong signals and sharp tuning. Supplied in 12 sizes for wave lengths from 52 metres to 5,700 metres. The strip can be supplied separately for constructors who wind their own coils.



12/6

"POLAR" PRECISION Variable Condensers

THESE Condensers are made in three capacities all having the same outside dimensions. Their construction provides at moderate cost large capacity in very small bulk with the advantages of perfectly smooth motion allowing delicate adjustment and fine tuning, constancy of calibration and accuracy of operation. They will stand rough usage and are extremely efficient and reliable.

.001 mfd., .0005 mfd. or .0003 mfd.

Obtainable from all Wireless
Retailers, etc.



Wholesale:—

METRO-VICK SUPPLIES LTD.,
4, CENTRAL BUILDINGS, WESTMINSTER, LONDON, S.W.1.

NEW "COSMOS" VALVES which will shortly be available.



Will be sold at
11/-

"COSMOS" A.45 BRIGHT FILAMENT VALVE.

This is a highly efficient valve for all reception purposes, being equally suitable for H.F. and L.F. amplification. It takes 0.65 amps. at 4.5 volts.

"COSMOS" S.P. 18 Shortpath DULL EMITTER.

This is an entirely new departure in valve design. The distances between the electrodes are so reduced that the electron stream has only to traverse a very short path, giving—greater Amplification, exceptionally good Rectification and Greater Output without Distortion. It takes 0.3 amp. at 1.8 volts and is EXCELLENT FOR "LAST STAGE" AMPLIFICATION.

Will be sold at
18/-



R
Q01

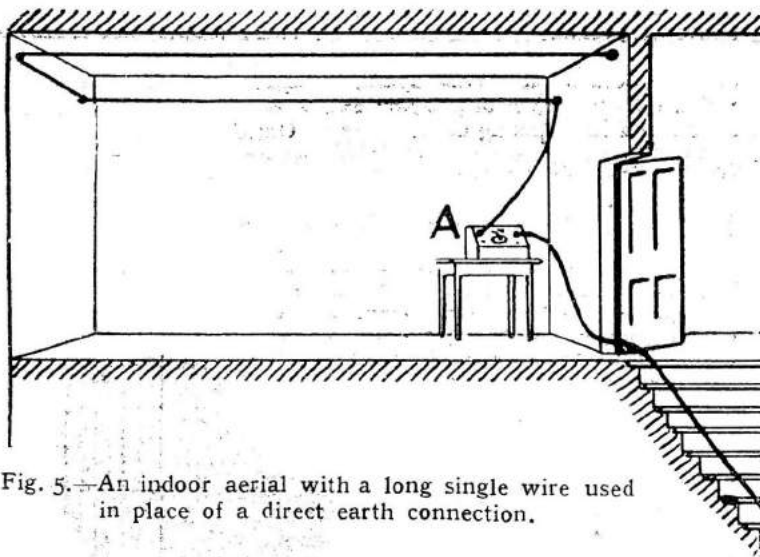

Fig. 5.—An indoor aerial with a long single wire used in place of a direct earth connection.

frequency amplification preceding the detector.

Fig. 5 shows a popular arrangement, the aerial being taken round three sides of a room, the earth wire being merely a single piece of insulated wire taken from the earth terminal down the side of the stairs for 20 or 30 ft. This arrangement often works just as well as if a direct earth were made upon a waterpipe or to a buried

plate in the garden, and should be tried when it is difficult to obtain access to a waterpipe or other suitable grounded object.

Within three or four miles of a broadcasting station (and thousands of potential listeners are so situated), good results on three or four pairs of telephones are obtainable even with a crystal set with such an indoor aerial. In those cases where it is possible, an improvement can

be effected by taking the aerial lead, not to a wire round the room, but to a similarly arranged wire round the loft, or along a landing above. In this case the aim should be to have the horizontal portion of the aerial as high as possible above the instruments. If you have time, you are advised to try experiments with the indoor aerial and to see which position in the house gives the best results, as it has been found that the electric-light wiring in the house, and also the disposition of gas piping and other metal work sometimes aids and sometimes hinders the reception with indoor aerials. In a few exceptional cases

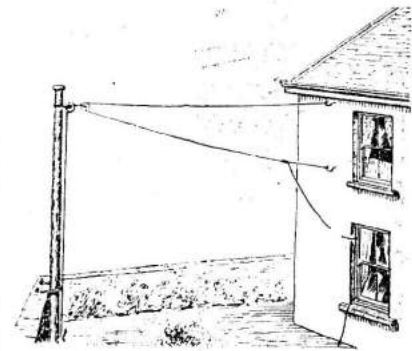
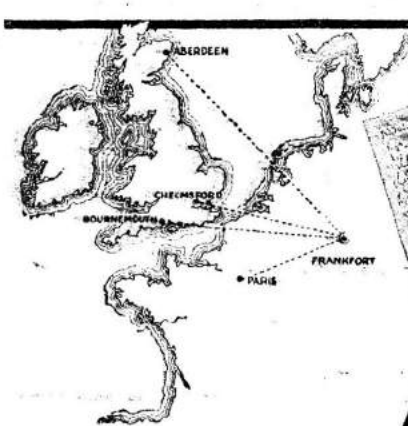

Fig. 6.—Another inefficient arrangement.



The postcard, reproduced here, reads as follows:—

"I bought one of your crystals here on Saturday last, and would like to tell you of my results. Frankfort of M., one-and-a-half miles off, on the L. Speaker, Radio-Paris and 5XX loud on one pair of phones, and still easily readable on five pairs. Sunday morning I got the concert from Koenigsrueterhausen on 2,800m., and after dinner 2-3 W.E. time, Radio-Paris. Monday evening I tuned in Bournemouth, 5XX, R-Paris, some other stations, which I did not wait to identify, and finally I got Aberdeen perfectly clear. I think for pure Crystal reception, without any amplification, this is nearly a record, the distance being over 1,200 Km. 5XX and R-Paris I can tune in while Frankfort is transmitting with a wave-catcher. My aerial is non plus ultra. With hearty congratulations on the excellence of your fabric. I am,
(Signed) HENRY HERZ-MILLS.
Wilhelmstrasse, 20, Frankfort of M.

Aberdeen, Chelmsford, Radio-Paris, Bournemouth and Aberdeen—received at Frankfort, Germany, on a Neutron Crystal, without amplifiers.

Sold by the best Radio Dealers. Packed in tin, with silver cat-whisker. Insist on Neutron, in the Black and Yellow tin. If unable to obtain, send 1/6 with dealer's name, and this wonderful crystal will be mailed by return.

1/6

An endorsement from Germany

Not only in this country, but also abroad, the fame of Neutron Crystal is spreading. Already widely known here as the crystal that breaks records for "distance," Neutron is being widely used by the amateurs of Germany, France, Spain and the British Colonies, who find it the most reliable, the most sensitive, and the Crystal that gives greatest volume—and distance.

NEUTRON

TRADE MARK

Concert Tested & Guaranteed Radio Crystals

Produced by NEUTRON, LTD.,
Sicilian House, London, W.C.1.
Phone: Museum 2677.

Sole distributors: V. ZEITLIN
& SONS, 144, Theobald's Road,
London, W.C.1. Phones: Museum 3705
& 6841

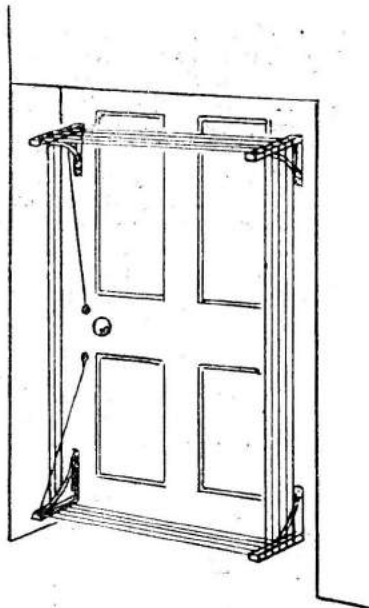

Fig 7.—This frame aerial is directional in its effect. The direction of best reception is found by swinging the door on its hinges.

results on indoor aerials have proved to be as good as on a fair-sized outdoor aerial, but as a rule we can say that indoor aerials are not so effective as those erected outside the house, provided these

latter are supported 20 or 30 ft. above the ground.

In this article we have purposely omitted details of frame aerials, which will be subject of a separate article in a forthcoming issue.

The "Short Wire" Valve Panel

SIR,—As a reader of THE WIRELESS CONSTRUCTOR, I feel I must write and thank you for the publication of the Short Wire Valve Panel which appeared in the Christmas number.

I have made this panel, and am really surprised at the results I get with it, using a Wecovalve and tuning with two coils, and a .0005 variable condenser in parallel.

The volume is indeed excellent, and quality exceptionally good. In addition, I have found tuning distant stations ridiculously easy, and I can get any night several other stations in this country beyond 2I.O, also I can get Madrid easily and French and German stations, and all with good volume.

I have tried quite a number of one and two-valve sets, but I am retaining this one permanently.

I am adding a I.F. valve on to

this set, and anticipate good loud-speaker results.

Once again thanking you,
Yours faithfully,
WM. C. CASSE.

Oxted, Surrey.

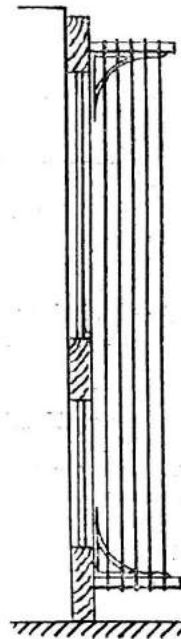
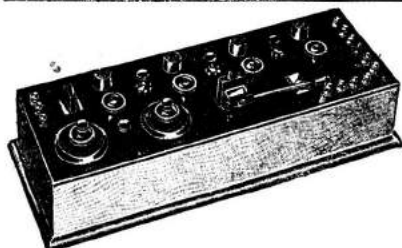

Fig. 8.—An edgewise view of the frame aerial.



CONSTRUCT THE 4-VALVE FAMILY for £9 0 0 (Envelope No. 2.)



MAGNUM H.F. TRANSFORMERS.

With Protected Windings. The most efficient H.F. Transformer obtainable. (See report in "Wireless Weekly.") 7/- each. Postage 3d. Guaranteed correctly matched 14/- per pair. (Postage 3d.)

No. 0	150-300
0A	250-525
1	300-600
2	550-1200
3	1100-3000

Special winding for Anglo-American Six referred to as Neutrodyne Units. Per set of 3 21/- (post free).



MAGNUM NEUTRODYNE CONDENSER. Specially designed and recommended for the Anglo-American Six and all Neutrodyne circuits described in Radio Press Publications 4/6 (postage 6d.). Carriage and Packing free on Retail orders value £2 and over.

THE POWERFUL 3-VALVE.

As described in this issue by Mr. PERCY W. HARRIS.

1 Polished Cabinet as described	12 6
1 Ebonite Panel Sq. matt & drilled 12"x10"x1"	12 7
1 Magnum 2 Coil Holder, type T.H.	9 6
13 Magnum Terminals, lacquered & complete	2 2
3 Sets Valve Sockets	1
3 Burnt Dual Rheostats for D.E. or Bright Valves	£1 2 6
1 Utility Sq. Law Var. Condenser .0005 complete	10 6
1 Gambrell Intervalve Transformer	£1 7 6
1 Igranite	£1 1 -
1 McMichael Fixed Condenser .0001	1 9
1 " " .002	2 3
1 Dubilier " " .0003 and Grid	5 -
Leak 2 meg.	9
1 pair Deco Indicators	7
5 yds. No. 16 sq. sec. T.C. Wire	6
1 Set Radio Press Transfers	£6 9 6

TAPPED REACTANCE UNITS.

As illustrated in "Modern Wireless" (February issue) page 3 and described by Mr. G. P. Kendall.

1st stage	Post free 15/-
Subsequent Stages	Post free 21/-

Anode Coils tapped and complete, as used in the Simplicity 3 and T.A.T. 8. - post free.

RADIO PRESS ENVELOPES. Post free.

No. 1. S.T. 100	1 9
No. 2. 4 Valve Family	2 9
No. 3. Simplicity 3	2 9
No. 4. All Concert de-Luxe	2 9
No. 5. Omni	2 9
No. 6. A.B.C. Wave Trap	1 9
No. 7. 2-Valve Amplifier-de Luxe	1 9
No. 8. 1-Valve Reflex	1 9
No. 9. Efficient Single Valve Radio Press Transfers	8

Note.—Leaflets dealing with the above Envelopes now ready.

BURNE-JONES & Co., Ltd.
296, BOROUGH HIGH STREET, LONDON, S.E.1
Telephone: Hop 6257. Telegrams: BURJOMAG
Sedist, London. Cables: BURJOMAG, LONDON
Mail order dept.: 288, Borough High Street,
London, S.E.1. All correspondence to 296,
Borough High Street, please.

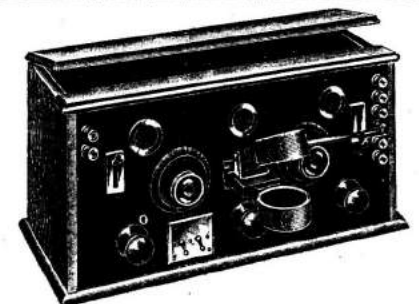

CONSTRUCT THE ALL-CONCERT-DE-LUXE for £9 9 0. (Envelope No. 4.)

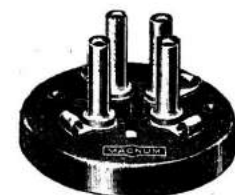

MAGNUM ANTI-CAPACITY VALVE HOLDER. An entirely new design made from best quality SOLID EBONITE specially channelled. As used on Radio Press Sets. 2 6 each (post free)

CONSTRUCT THE A.B.C. WAVE TRAP for £2 (Envelope No. 5).

Assembled and Wired complete £2 17 6

SPECIAL FORMER FOR A.B.C. WAVE TRAP 5 6

Send stamp for illustrated list and set of leaflets dealing with Radio Press Circuits.

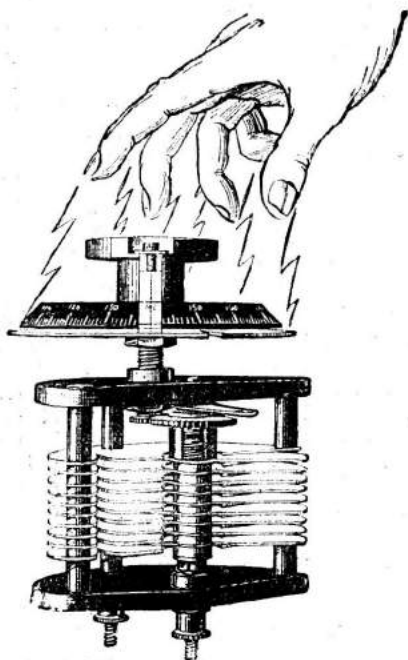

Makes Tuning twice as Accurate

The "Fulstop" Variable Condenser possesses many valuable improvements in condenser construction. It enables tuning operations to be carried out with a hitherto unobtainable accuracy and completely abolishes all hand capacity effects. In addition to being a square law condenser which prevents the overcrowding of stations, the "Fulstop" condenser is so made that the whole of the circumference of the dial is graduated, and being geared at two to one in relation to the moving plates, it allows twice the range of accuracy to be found in ordinary condenser design. This allows for very fine tuning and increased audibility. This condenser has been strongly recommended by the wireless press for use in situations where great accuracy is desired.

The only condenser which guarantees the elimination of hand capacity effects.

PRICES:

•001.....13s. 6d. •0003.....19s. 3d.
 •0005.....11s. 3d. •0002..... 9s. 6d.

Stocked by most Wireless Dealers, but if you have any difficulty write to—

J. H. NAYLOR, Ltd., WIGAN

Fulstop

VARIABLE CONDENSER

The WADE WIRELESS TOOL-SET



Here, at last, is the real Wireless Tool Set that every Wireless Constructor has been waiting for. No more spoiling a good panel by using the family screwdriver, hammer, and gimlet; no more trying to tighten nuts with an adjustable car spanner or a pair of pliers.

The Wade Wireless Tool Set includes:—

- 1 Extra Length Screwdriver, which enables you to get at screws inside your Set without fouling the wiring system.
 - 1 Broad Screwdriver for turning all ordinary screws.
 - 1 Wire Bender; invaluable for bending wire to any shape.
 - 1 Hammer, for cabinet construction, straightening wire and for use generally where household hammer is far too clumsy.
 - 2 Box Spanners, 4 B.A. and 6 B.A., absolutely essential for turning nuts in awkward places. They replace pliers, which always burr up the nuts.
 - 1 Counter Sink, to enable screw-heads to be sunk to the panel level.
 - 1 Reamer, for enlarging holes to any diameter. Replaces numerous and costly drills.
 - 1 Bradawl for starting screw-holes.
 - 1 Double-sided File for smoothing-off soldered joints, etc.
- All these tools fit into the Universal Holder provided.

If you cannot get the tool-set from your local dealer, send direct to us, kindly mentioning the dealer's name.



C.A.V. SMALL TOOLS LTD., 181, Queen Victoria St., E.C.4
 E.P.S. 26



Correspondence

THE ANGLO-AMERICAN SIX.

SIR,—I am writing to give you a report on the "Anglo-American" six-valve set which I have constructed according to your description in *THE WIRELESS CONSTRUCTOR*. It is by far the best of several sets made in the past from Radio Press circuits.

I am using McMichael square-law condensers; "Polar" verniers as stabilising condensers; "Burndept" dual rheostats; Marconi-phone "Ideal" 4-1 transformer, &c.

The set is extraordinarily simple to handle for a long-range set, and the purity of reproduction on distant stations is superior to any other I have heard. All B.B.C. main stations, of course, come in at great volume on two Amplion loud-speakers, and Continental stations seem to roar in "all over the dials." As the set has only been in operation a few evenings yet, I have still to get into touch with the U.S.A.

It seems highly desirable to use only parts of the highest quality in this set. I have replaced several components by others of better quality, with marked improvement. The valves used are B.T.H. B.5's for H.F. and Det., with another B.5 as first L.F. and a B.6 last. This combination certainly works excellently, and uses a negligible amount of filament current. Perhaps the best results as regards purity are obtained by using a valve of low impedance before the Marconi-phone L.F. transformer as Det., and followed by a D.E.5.B. for the resistance-capacity coupled stage, with an L.S.5 last of all. H.T. used is 30 volts for the H.F., 15-18 volts Det.; and I.F. according to the particular valves in use at the time. The correct H.T. voltage and grid bias is important if undistorted reproduction is desired, using the valves and transformer named. I could not get the last stage to work well with 100,000 ohms resistance, but the substituting of a Dubilier 80,000 ohms made all the difference.

One of the most attractive things about the "Anglo-American Six" is its appearance. The polished mahogany cabinet, lustrous black dials, knobs and panel, coupled with the nickelled fittings, make it an ornament for any home.

I am looking forward to spending many pleasant evenings, thanks to you and the Radio Press, with the finest straight six-valve yet designed.

Yours faithfully,

R. H. MILLINGTON,
Manchester.

I also get a host of Continental stations, Breslau, Rome, and Madrid. Chelmsford comes in on the loud speaker, loud enough to hear every word comfortably at the far end of the room, 17 ft. away. London also I have had on the loud speaker. Almost as loud as Chelmsford. The only difference I made to the set was to fit two Sterling condensers, with verniers, and I used an R.I. transformer. I am not carried away by enthusiasm, as I am the possessor of one of the latest model

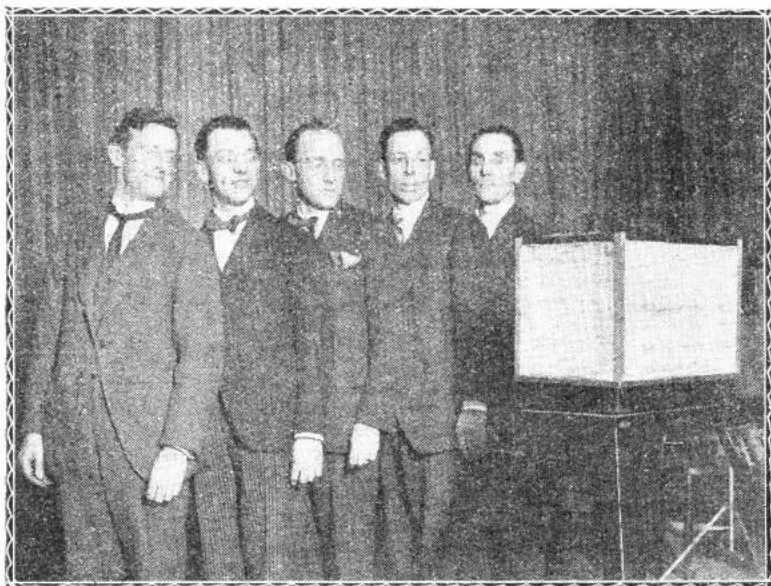

The well-known "Roosters" Concert Party at 2L.O.

THE SINGLE-VALVE REFLEX RECEIVER.

SIR,—I have made up the one-valve reflex as described in the February issue of *THE WIRELESS CONSTRUCTOR*. I am astounded at the results. I can get almost any main B.B.C. Station any night at good phone strength. London, Birmingham, Newcastle, Glasgow, Belfast, and Bournemouth come in very strongly. Aberdeen I can always get with careful tuning, but never very loud, although loud enough to follow the pro-

4-valve receivers. I merely make these little sets for amusement. I have made several, but this one easily surpasses the others as far as receiving distant stations goes.

Yours faithfully,
ROBT. HAMILTON,

Ashford, Kent.

I forgot to mention my aerial is I shape, 100 ft. long, 45 ft. high, unscreened. Earth, three bare copper wires, 6 gauge, 6 ft. apart, exactly under aerial, and extending its full length. Buried in ground 6 in. deep.

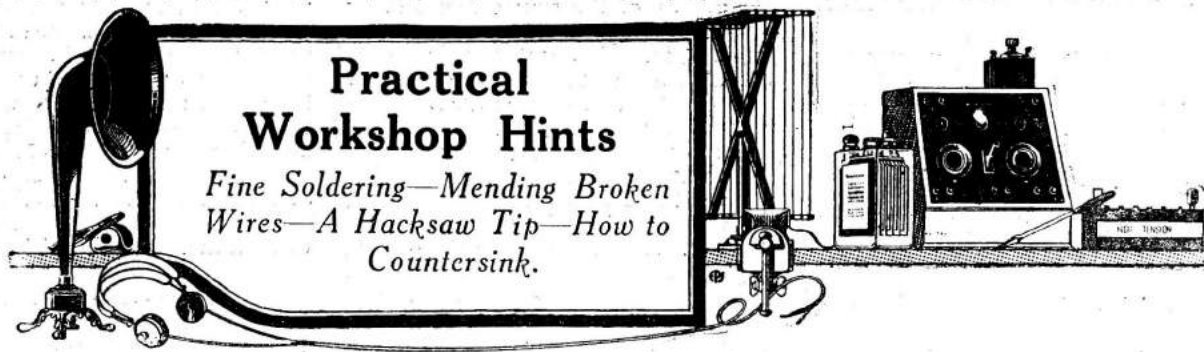

Practical Workshop Hints

Fine Soldering—Mending Broken Wires—A Hacksaw Tip—How to Countersink.

Fine Soldering
THOUGH the majority of wireless soldering jobs are pretty straightforward, one occasionally comes across a rather finicky piece of work which is not easy to deal with. The kind of job I mean is that which has to be undertaken when a break occurs at one end of the fine windings of a potentiometer or of a dull emitter rheostat. Another piece of soldering which calls for a little skill and patience is the refixing of a low-frequency transformer lead which has come adrift from its terminal or tag. For this kind of work the small iron which can be purchased for a shilling or so at most tool shops is

very handy, provided that it is made of pure copper. Beware always of buying cheap soldering irons, for if you get hold of one

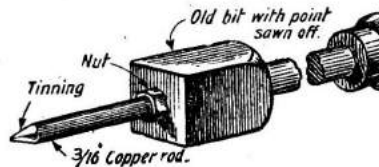

Fig. 1.—A soldering iron for fine work.

with a bit made of copper containing impurities, you will find it very difficult to make solder take properly. The small iron has, however,

one great disadvantage, which is that it grows cool so rapidly. If I am using these irons for fine work I arrange a little stand made of bent wire which will support the soldering iron, so that its bit is in the flame of a spirit lamp placed on the table. It is quite a good idea to use a pair of irons, for then a hot iron is always available, since while one is in use the other is being heated by the lamp. Really, though, it is more satisfactory to use something with more "body" for heat retaining purposes, and here is a tip which will be found very useful. With a hacksaw cut off the point of an old bit of respectable size. Then in the

STOCKISTS

- BIRMINGHAM:** S. M. Spain, 1029, Rushmore Road, Stirchley.
BISHOP'S STORTFORD: E. W. Little, Ugley.
BRISTOL: Bristol Wireless Co., Radio House, Queen's Road; Colston Elec. Co., 9, Denmark Street; Central Wireless Depot, 24, North Street, Stokes Croft; H. Salansan & Co., High Street.
BURTON-ON-TRENT: E. Mellor, Borough Road.
CAMBS: Setchfield Bros., High Street, Maney.
CHESTERFIELD: H. E. Drabble, 25, Market Street, Staveley.
COVENTRY: Coventry Wireless Supplies, Ltd., Far Gosford Street.
DEVIZES: J. S. James, 13, Maryfort Street.
DONCASTER: W. H. Henderson, The Garage, Rossington.
DUBLIN: Pitman, Son, & Cooper, 16, Crow Street.
DUNGANNON: Elliot Bros., 2, Park Road.
EXETER: City Vulcanizing Works, 22, Paris Street.
FELPHAM: Felpham Motor Works, Ltd.
FROME: G. F. Thick, Church Steps.
GLOUCESTER: Edwinton Green & Sons.
GUERNSEY: A. H. Laine, St. Sampsons.
LEICESTER: Sports, Ltd., 7, Belvoir Street.
LONDON: A. J. Dew & Co., 24, Rathbone Place, W.; Houghtons, Ltd., 88, High Holborn, W.C.; Murbach Trading Co., 59, Clerkenwell Road.
SAISBURY: Western Wireless & Electrical Co., Fisherton Street.
SKEGNESS: Skegness Radio Supply Co., 28a, Lumley Road.
WALSALL: Holdsworth & Co., 75, Upper Bridge Street.
WEST B. O'AWICH: Radio Stores, 309 High Street.

Notice to the Trade

There are many districts still open. Write for details of our plan which will enable your name to be added to this list.

Bar. Lays 824.

RADIAX REACTANCE UNIT.



Instantly fixed to any panel—5 coils cover the range from 100 to 4,000 metres. No. 736 with coil 309/1,600 metres. **6/9**

Ex. coil for 100/300 **3/3**
 Ex. coil for 1,000/4,000 **3/9**

HERALD L.F. TRANSFORMER

Built to the proved most efficient design. Gives high amplification without distortion, and if in these respects it does not equal any first-class transformer against which it is compared, we will accept return within 10 days. Price **12/6**



RADIAX H.E. LOW LOSS COILS

The waxless inductances which increase volume, sharpen tuning and improve reaction. Guaranteed unsurpassed by any other make or type. Their unique construction makes them rigid and strong to handle. Set of 6, including Chelmsford, with strong adjustable ebonite mount. Standard fitting, 25, 35, 50, 75, 100, 150 **7/9**



Postage at Set of 9, up to No. 300 **16/9**
 Mounted on Standard Plugs—Set of 6 **12/6** (postage 4d.) Set of 9, **25/6** (postage 6d.)

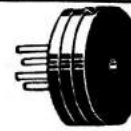

Transformers H.F. (or tuned Anode Coils)

We specialise in H.F. Couplings and Reaction Units of all kinds. Complete Catalogue of Radiax Sets, Components and Accessories. Post Free 3d.
Wavelength Price.
 300-500 .. **3/6**
 500-900 .. **4/3**
 900-1600 .. **4/9**
 1500-2600 .. **5/6**
 2600-4000 .. **6/6**

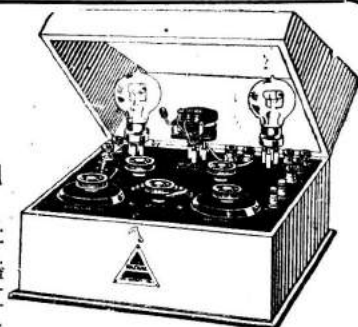

RADIAX UNIVERSAL RECEIVERS

are powerful regenerative sets which will deal efficiently with all wavelengths and embody detail refinements which few othersets, however expensive, can boast. They are wonderful for distant reception. Supplied complete with plan, diagram, fully drilled and engraved panel, and every detail required.

The following is a small selection: Constructor's Sets. Valve Units from **17/6**.

No. 31 P 1 Valve Reflex	£4 15 0
No. 24 P 2 Valve Set	£4 15 0
No. 26 P 3 Valve Set	£7 5 0
No. 28 P 4 Valve Set	£9 15 0
No. 30 P 4 Valve Set	£9 7 6

Completed and Tested Sets. Valve Units from **27/6**.

No. 31 P 1 Valve Reflex	£6 12 6
No. 24 P 2 Valve Set	£9 12 6
No. 26 P 3 Valve Set	£10 17 6
No. 28 P 4 Valve Set	£15 0 0
No. 30 P 4 Valve Set	£15 0 0

(Plus Marconi Royalty, 12/6 per valve.)



RADIAX Ltd., 44, RADIO HOUSE, PERCY ST., TOTTENHAM CT. RD., LONDON, W.1
 3 minutes from Tottenham Court Rd. and Goadge St. Tube Stations. Phone: Museum 490.

Ancient and Modern

Terminal connections for 'phones and loud speakers are a thing of the past. The up-to-date method is plugs and jacks.

Simple—Safe—
Convenient—
R A P I D

connection is provided by use of

**G.R.C. 112
RADIO PLUG 4/-**



and

**G.R.C. 118
Solderless
RADIO JACK 2/6**

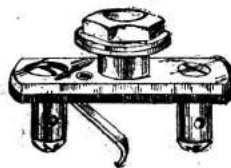

General Radio *

products with the "General Radio" guarantee.

*"General Radio" on a broadcast Receiver or Component means that it is definitely guaranteed to give complete satisfaction.

Issued by the Publicity Department of the General Radio Company Ltd., Radio House, 235, Regent Street, W.1.

middle of the square face left by the removal of the tip drill and tap a $\frac{3}{16}$ in. hole about $\frac{1}{2}$ in. in depth. Obtain a 3 in. length of pure copper rod $\frac{3}{16}$ in. in diameter, screw one end for about $\frac{1}{2}$ in., and file the other to a point. Run a nut on to the threaded end. Screw the rod home into the face of the bit, and then lock in place with the nut. If you cannot do the drilling and the tapping jobs in your own workshop you can get them done very cheaply at any cycle shop or garage. When the pointed end of the rod has been properly tinned you have a soldering iron which will enable you to do very fine jobs, but which at the same time will retain its heat well, owing to the fact that the point is set in a comparatively large mass of copper. The iron is made still handier if the large bit is filed down into a kind of pear-shape with the small end towards the pointed rod.

Resoldering Broken Wires

The actual business of resoldering a fine wire which has come adrift, or of repairing a break in, for example, the windings of a potentiometer is less difficult than it looks. If the end has simply come adrift from its tag you will probably find that you have to sacrifice one or two turns in order to give you sufficient length of wire to get hold of. This will not make the least difference to the performance of the potentiometer, for it will only reduce its resistance by a very small amount indeed. Get the wire

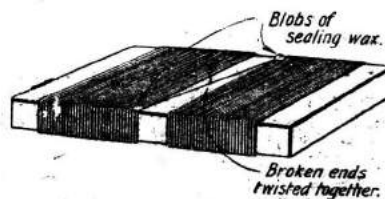

Fig. 2.—Showing how broken wires may be joined.

as tight as you can on the former, and hold the windings in place with the thumb and forefinger of the left hand. Get rid of the insulation at the end of the wire by holding a match flame an inch or so below it, and scraping it away when charred. Do not bring the wire actually into the flame, or it will become very brittle if it does not actually burn up. Now wind the bared end two or three times round the tag, apply a little flux, and solder quickly with a very hot iron. If the iron is hot enough the solder will run on instantly, but should it be on the cool side it may take you some time to make it stick properly, and the job

when finished will be neither neat nor secure. When a break occurs in the middle of the windings, as it sometimes does, a few turns will have to be removed. Care must be taken to see that the joint is not made in the path of the sliding contact, or there will be a jump whenever the potentiometer is adjusted, and another break is almost certain to occur in a short time. Tighten up

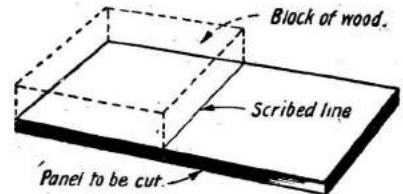

Fig. 3.—How to use a guide block for cutting ebonite.

the windings, and secure both ends with a little blob of sealing wax, which again must not be placed on the path of the slider. Twist the broken ends together as shown in Fig. 2, apply a little flux, and solder quickly as before. In the drawing the gap left in the windings as the result of the repair is very much exaggerated. Actually, with a little care one can mend broken windings, so that there is practically no gap at all in the path of the slider. When soldering has been done the twisted ends of the wires should be snipped off quite short.

A Hacksaw Tip

For cutting up ebonite there is nothing to beat the jeweller's or dentist's hacksaw, or a fretsaw fitted with blades specially made for dealing with tough work. It may, however, be found that if blades are fixed in the frame in the ordinary way, that is, so that they cut during the thrust part of the stroke, they have a tendency to buckle and break owing to the toughness of ebonite. When using these fine blades I find it better to adopt the Chinaman's method of sawing and to insert them in the holder so that they cut not on the thrust, but on the draw. Somehow it seems much easier to work with a fine blade set in this way, and, if you try it out, you will find that you do not have breakages nearly so often as when the blades are inserted in the normal manner.

Cutting a Straight Edge

Some people maintain that it is very difficult to go straight when cutting a longish edge with a small blade such as the fretsaw. Personally, I think that it is much easier to do so with this kind of

tool than with the ordinary hacksaw. The way in which I generally cut out panels is as follows. The line of the cut is, first of all, deeply marked with the point of a scriber. It is of no use to use a pencil for the purpose or to make the merest scratch with a scriber, for, if you do so, you will find that your line is constantly being obscured by ebonite dust as you work. The panel is then placed in the vice, between whose jaws and its surfaces pieces of wood are inserted to prevent disfigurement of the ebonite. The panel must be so placed that the scribed line is quite vertical. The saw is then started very carefully and cutting proceeds quite quickly. If one stands close to the work, with one's right eye directly over the scribed line, it is surprisingly easy to cut the edge so true that it requires very little trimming subsequently.

Displacement Effects

I find it best to close the left eye, for then there is no possibility that any displacement effect will occur, and hand and eye work so well together that the blade shows no tendency to leave the line. Those who find that in spite of all their endeavours they cannot keep straight with either hacksaw or fretsaw will do well to use another method of cutting out panels. This is to employ a stiff-backed or tenon saw. When this is done it is best to make use of a guide block, as shown in Fig. 3. This is a piece of wood which is

laid upon the panel so that one of its edges, which must, of course, be perfectly straight, lies along the scribed line. The block is either clamped or held in place with the left hand and it prevents the saw from getting out of alignment. With a tenon saw edges can be made dead straight, but this method of cutting out ebonite is rather tedious, for it takes much longer than when a hacksaw or fretsaw is used.

Countersinking Made Easy

A job which many amateur constructors find difficult is to countersink neatly the heads of those screws which appear on the surfaces of their panels. Nothing looks neater than a panel with screw heads quite flush with the surface, and few things look worse than one in which some screws project a little, whilst others are too low. If you are the fortunate possessor of a bench drill, accurate countersinking is not very difficult with either hand or automatic feed. With the former experiment first of all on a piece of scrap ebonite, and discover the exact number of turns of both crank and feed wheel which are needed to produce a hollow of the correct depth. Make the same number of turns at each hole dealt with on the panel, and the results will be all that they should be. With the automatic feed it is necessary only to count the number of turns made with the crank, for the machine does the rest by itself. With the hand or breast drill, however, matters are rather more

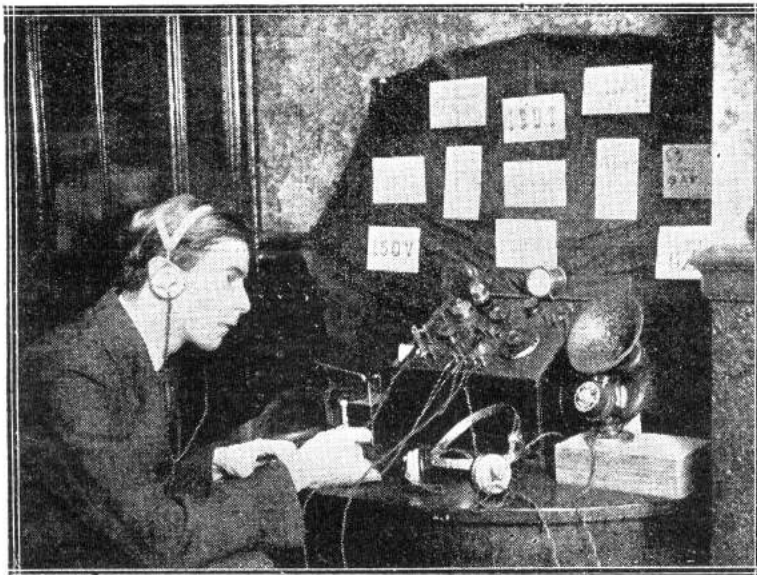

Mr. T. A. Studley, of Harrow, who has received many American amateur stations on a single valve set.

Quality RADIO

COMPONENTS

Profusely illustrated twelve page CATALOGUE just out. If your dealer cannot give you one send us a card with his name and address to receive it direct FREE and POST FREE.

EFFICIENCY AT A MODERATE PRICE WITH

Quality RADIO DUPLEX COILS

Compare our Prices, and ask your Dealer to show you samples.

25, 1/6; 50, 2/0; 100, 2/9; 175, 3/6; 35, 1/9; 75, 2/3; 150, 3/0; 200, 3/9.
Postage 3d. each. Set post free.

LEGLESS VALVE HOLDERS 1/6 post 2d. Acts as own drilling jig.

BOX SPANNERS for B.A. NUTS.
2, 4, 5 and 6 B.A. Price 1/0 each.
Postage 3d.

If your dealer has not got them we send post free if you mention his name and address.

GOSWELL ENGINEERING CO., LTD.,

12a, Pentonville Rd., London, N.1.
Liberal Trade Terms. Phone: North 3051.



The Service
of the
HOUSE of GRAHAM
A statement of interest
to All Radio users

DO YOU already possess a Loud Speaker? Have you only tried one tentatively—and been disappointed? Would you like to obtain more sensitivity or volume from your receiving set, and get distinctly better Loud Speaking results?

If there are any such problems requiring a solution, do not hesitate to take advantage of our Service. It is at your disposal in words, when you want advice—and in deeds, when you want results. It is offered entirely free of charge.

Every AMPLION is guaranteed to afford satisfactory results whenever it is associated with a reasonably well-designed and properly tuned receiving set, and this guarantee is unconditional.

The Service Section of the house of Graham is, moreover, in a position to offer positively unbiassed advice and information to users of AMPLION Loud Speakers, whether the set used is of any particular make or simply an assembly of components.

This work is regarded as a "mission" towards the universal aim of:

BETTER RADIO REPRODUCTION
which becomes in every case a practical certainty for those who use the

The
World's
Standard

AMPLION

Wireless
Loud
Speaker

A PRODUCT OF THE
HOUSE OF GRAHAM.
Obtainable from **AMPLION STOCKISTS** and
Wireless Dealers everywhere.
ALFRED GRAHAM & COMPANY
(E. A. GRAHAM)
St. Andrew's Works, Crofton Park, London, S.E.4



EXCEL
TERMINAL TAGS

PERFECT RECEPTION requires perfect electrical contact throughout your receiver.

USE EXCEL TERMINAL TAGS for every radio job and make certain of best results. Quick and easy to fix. Your dealer will supply all types.

See the name "COLLETT" on every tag

Barclays 834.

IMP BATTERY SWITCH

Here is the switch you have been waiting for. "On" and "Off" position clearly indicated at all times. Will carry 10 amps. Ask your dealer to show you. Insist on the original. Price **2.9**

Gaston E. Marbaix,
27-28 Anning Street, E.C.2
Phone: Bgate 1294.

PICKETT'S CABINETS
De Luxe Model Polished
Takes Mahog.

Panel any	Oak
12 x 9	27s. 6d. 22s. 6d.
12 x 12	30s. 0d. 30s. 0d.
12 x 15	40s. 0d. 34s. 6d.
12 x 18	45s. 0d. 38s. 6d.

Carv. extra. Estimator
—Per Return Post.
Send for cabinet Designs and Lists Free
Cabinet (W.C.) Works,
Bexley Heath, S.E.

EBONITE BUSHES

For mounting on Wood Panel. Perfect insulation. Price 1/- for 12 (post free). Easily fixed by drilling a 1/4" hole.

DAREX RADIO Co.,
STANDARD WORKS
Waldram Rd., Forest Hill, Trade Supplied.
London, S.E.23.

COMPONENTS

for any set described in this issue of the WIRELESS CONSTRUCTOR can be obtained from:

THOMAS BROS., Radio Specialists,
TREETON, Near ROFFENHAM.
Enquiries invited. Lowest Quotations.

ELECTRADIX RADIOS

6" Valves, Air Force, low loss, 6/6 (post ab buyer's risk). Wavemeters, 30/-, 24, 25 and 26. Morse Recorders, 20 20s.; Wheatstone, 25. Alternators, 23 10s. Valve Transmitters, 23. Spark Sets, 25/6. R.A.F. Steel Masts, 2/6 per 5 ft. run. Receivers: 2-valve, 2B, 22; 3-valve, Mk. 4, 22; 5-valve, 25 10s.; 7-valve Marconi, 28. All prices less valves. Bridges, 23 and 25 10s. Res. Boxes, multi-range standards, 1 to 2,000 ohms, 17/6 to 50/-. Loud Speakers, 20/-. Ebonite forms, 5/-. A.C. Chargers, 24 20s. Charging Dynamos, 23. Marconi Round Valves, 3/6. Milliammeters, 27/6. Micro Ammeters, 65/-. Amp. and Voltmeters, all ranges. Ohmmeters, 210. Testing Sets, 24 to 214. Condensers, L.T. to 10,000 v., 2/6 to 22. Call or write for new and enlarged catalogue. Post free, 4d.

LESLIE DIXON & CO., LTD.,
9, Colonial Avenue, Minories, E.1.
Buses pass the door. Telephone—Avenue 4166

A.W.U.

complicated, for even if you count the turns given to the crank most carefully it is not easy to make sure that you are always applying exactly the same pressure. Six turns may therefore produce a hollow which is slightly shallower or deeper in one case than it is in another. Fig. 4 shows a very useful little fitting for the countersink which when used in one of these drills enables you to turn out first-class work with absolute certainty. It consists of a collar made of hard wood, through which is drilled a hole, into which the body of the countersink fits tightly. If the countersink is of the standard pattern with a $\frac{1}{4}$ in. shank, the diameter of its body will be $\frac{3}{8}$ in. As most amateurs use only one size of screw, No. 4 B.A., for mounting components on their panels, a single guide collar will suffice for all jobs. The depth of the collar will depend upon the exact length of the body of the countersink, and must be found by experiment. To do this proceed as follows:—In a piece of scrap ebonite drill a $\frac{1}{4}$ B.A. clearance hole and countersink it to exactly the right depth, so that the screw lies perfectly flush. Remove the countersink from the chuck of the drill, place its point in the hollow made and

measure the distance from the surface of the ebonite to the shoulder of the countersink. Make the guide block just a little longer than the distance measured. Next drill several $\frac{1}{4}$ B.A. clearance holes in an odd piece of ebonite. Replace the countersink in the drill, put the collar on to it, and run it in

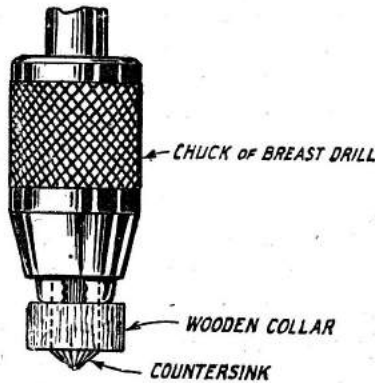

Fig. 4.—A countersink guide.

the first of the clearance holes until it is brought up by the collar. Try a screw in this hole and notice how much too high it is. Then place the lower end of the collar on a sheet of glass paper and rub it down a little. Test again

by countersinking a hole and continue the rubbing down process until you obtain the exact length required. Though it takes some time to describe the process is not really a very long one, and the collar, once made, besides lasting indefinitely, will be found a valuable saver of time and trouble. When using a guide collar, do your countersinking *before* you give the panel its final surface. By doing this you ensure that any marks made by the collar on the ebonite are removed during the finishing process.

Have you bought your copy of the Spring Double Number of "MODERN WIRELESS" ?

The following valuable articles are among the host of interesting matter:—

- The Neutrodyne Junior Cabinet set. By Percy W. Harris. (With free blue print.)
- A Simplified 3-valve Dual. By John Scott Taggart, F.Inst.P., A.M.I.E.E.
- Post-Bag Puzzles. By A. R. Burrows (Uncle Arthur).
- FREE BLUE PRINT.
- On Sale Everywhere.
- Price 1/6.

An Enormous US

—improvement in reception.

MAGNIFICATION WITHOUT DISTORTION

THE U.S. Super Transformer has been proved the equal of any transformer on the market, irrespective of price. It is Good and Guaranteed! Ratio 5:1. Price 13/6 from all dealers, or direct from

THE U.S. RADIO Co., Ltd.
(Transformer Dept.)
155, High St., Lewisham, S.E. 13.
Phone: Lee Green 2404.
Wires: Supertran, Lewis, London.

All British

Super Transformer

Note the New Earthing Terminal

WHICH ?

Brown lived next door to Jones. They both made their sets. Same sort of components—same valves—same condensers—in fact same everything, except one small thing—and that was all the difference. Jones fretted, whilst Brown sat continually "listening in." In no way was Jones' reception to be compared with Brown's. And that provoked Jones sadly. You see, Brown methodically soldered the wiring of his circuit. Jones despised that as unnecessary—and called soldering a finicky and difficult job. Soldering is made simple by using the wonderful FLUXITE, so follow Brown's example and solder your connections right away and so avoid imperfect reception.

Ask your Ironmonger or Hardware Dealer to show you the neat little

FLUXITE SOLDERING SET

Price 7/6

It is perfectly simple to use, and will last for years in constant use. It contains a special "small space" Soldering Iron with non-heating metal handle, a Pocket Blow-lamp, FLUXITE, solder, etc., and full instructions. Price 7/6. Write to us should you be unable to obtain it.

FLUXITE SIMPLIFIES SOLDERING

All Hardware and Ironmongery Stores sell FLUXITE in tins, price 8s., 1/4 & 2s.

Buy a Tin To-day!

FLUXITE, LTD., 230, Bevington St., London, S.E.16.

ANOTHER USE FOR FLUXITE
Hardening Tools & Case Hardening
ASK FOR LEAFLET on improved methods

Steady as
a Rock



MULLARD EVER-REST GRID LEAKS

are silent in use and constant in value. Absolutely unaffected by climatic conditions. Made in two types:

- (1) For grid leaks with suitable condensers and
- (2) For Anode circuits of resistance amplifiers.

EVER-REST Grid B
3 to 5 megohms, 2/6 each.

EVER-REST Anode B
20 to 0.1 megohms, 2/6 each.

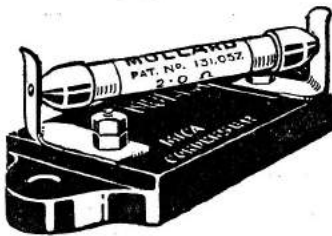

Complete with high standard and guaranteed exact capacity fixed condenser.

Grid B with .0003 mfd. Condenser Type M.A., 5/-

Mullard Condensers only

Type M.A.
.0002—.004 mfd., 2/6 each.

Type M.B.
.005—.01 mfd., 3/- each.

**MULLARD
EVER-REST
GRID LEAKS**

Advt. (Mullard), Nightingale Lane, Balham, S.W.12.

The Editor at 2LO

A short "wireless" talk broadcast from the London station on Thursday, February 12th

WE are all so used to talking about the art of radio as "wireless" that we are apt to forget the importance of the wire we have to use, and, as many of the troubles which face the wireless enthusiast are connected with wire, it occurred to me that a short chat on some difficulties with "wireless wires"—if I may use the term—would be helpful to listeners.

The other day I was asked by a friend why it was that whenever the wind was blowing he heard all kinds of strange crackles in his telephones, while signals went up and down in strength and sometimes failed completely. A brief examination showed that in erecting his aerial he had not used one continuous piece of wire, but two or three odd pieces joined together. Instead of making firm, sound, soldered joints, he had simply twisted the bare strands together, and, while this served excellently when the wire was new, dirt and corrosion had worked their way into the joints, so that whenever the wire was bent by the wind there were imperfect contacts between the parts. Both the fading and the crackling noises were due simply to inefficient joints, and I would advise you all to make quite sure that you have good, sound aerial joints before blaming the B.B.C. or the weather.

Don't Blame the 'Phones

Another friend grumbled to me that the telephones now sold were of very poor quality, and, although he had invested in at least half a dozen pairs of leading makes, they had all broken down in a few weeks. Wireless material is turned out in such quantities to-day that occasionally, even with the best makes, a faulty pair of 'phones may get through, although in my own experience this is an extremely rare occurrence. I knew that the chances of faulty pairs of each of the makes he mentioned getting into his hands was so remote as to be negligible, and there must be some other cause. I found when I went home with him that he was in the habit of laying his 'phones down anywhere, and while I was in the house they were twice knocked

on to the floor. Now, the wire used to wind telephones is extremely fine—one might say the human hair is coarse compared with it. In spite of its fineness it is quite strong enough to carry the current normally passed through it, but it will not stand the strain imposed upon it by a sudden jar such as might be caused by dropping from the table to the floor. If the truth were told, it would probably be found that my friend's telephones were all spoiled by being dropped on the floor, and he seemed quite surprised when I pointed out to him that care was necessary in this way.

Transformer Breakdowns

We often hear of low-frequency transformers burning out. Actually a burn-out in the sense of the wire fusing through too heavy a current is an extremely rare occurrence, and in most cases where we are told a burn-out has occurred it would be much better to refer to it as a breakdown. When we suddenly start or break a current in the windings of an inter-valve transformer, quite an appreciable strain is set up by the magnetism in the core, and if the thin iron laminations are at all loose, the change in magnetism may cause contraction and expansion of the core. I have heard of a number of transformers breaking down through the user making far too many changes of high-tension voltage. When you are deciding the high-tension voltage to use with your receiver, make the adjustments very carefully and avoid at all costs taking your wander-plug and plugging it indiscriminately in all kinds of voltages. Constantly stopping and starting the current in this way sets up quite unnecessary strains and should be avoided where possible.

Other wires which will give trouble if they are not properly used are the flexible wires in the telephone cords. Do not allow these to get twisted into knots. A little care will prevent this and your telephone cords will last much longer.

Another wire of vital importance to your crystal set is the cat-whisker. Some of the very first crystal receivers had, not a single

wire for contact, but a small bunch of wires, and in these small bunches of wire some acute observer noticed the resemblance to a cat's whiskers. Although a small bunch of wires is still sometimes used, the general form of contact is a small springy wire which has not the remotest resemblance to a whisker of a cat or any other animal. The name still persists, however, and will be a long time in dying.

Perhaps you have not thought of wires in connection with your valves, but the most delicate wire of all is the slender filament from which the electrons are shot off when the valve is heated. Some people seem very unfortunate with their valves and wonder why they burn out so quickly. Of course, I trust you all know that you must not connect the high-tension battery to the low-tension terminals, even for the fun of seeing what happens, although a surprising number of people manage to do this in some way or another. It is less generally known that the life of a valve is very considerably shortened if the filaments are burnt too brightly. If you are using a bright-emitter valve rated by the manufacturers at 4 volts on the filament, and you are using a 6 volt accumulator, you will need

to turn the knob of the average filament resistance only just "on" to get the best adjustment. If you turn the knob full on, you will be placing a full 6 volts on the filament and the life of the valve will be much shortened. Not only will you shorten the life of the valve, but you will not get any better work from

it. It is a safe rule to burn your valves only just as brightly as will give you the signals you require. Dull-emitter valves want much more care, for, although their filaments may not burn out through being burnt too brightly, they will lose that peculiar emitting property upon which the work depends.



This funny collection of instruments is used at the London station to produce the noises which give such a natural effect in the broadcast plays.

THIRTY TESTS

Every pair of "General Radio-phones" is constructed of materials which have been carefully tested over *thirty times*, before the completed 'phones are passed as perfect.

That is one of the many reasons why we get so few returns and why we can safely attach the broad

General Radio *

guarantee to each pair.

* "General Radio" on a Broadcast Receiver or Component means that it is definitely guaranteed to give perfect satisfaction.



20/-

For seven ounces of Super Sensitivity

Issued by the Publicity Department of the General Radio Company, Ltd., Radio House, 235 Regent Street, W.1

In replying to advertisers please mention THE WIRELESS CONSTRUCTOR.

DOES IT PUZZLE YOU?
THREE INTERESTING QUERIES
ANSWERED

*What Constitutes a Good Earth—A Crystal Question—
 Working a Loud-speaker*

In the absence of a convenient main water pipe, what alternative earth connection can be used?

(1) An old galvanised iron bath or bucket, perforated with holes, should be buried two or three feet beneath the surface of the soil, underneath the aerial and as close to the "leading-in" point as possible. A stout copper wire should be soldered to the upper edge of the bath or bucket, which should be almost filled with cinders or preferably broken coke. Three or four bucketfuls of water should then be poured in and the earth shovelled back. (2) A corrugated, galvanised iron sheet (as large as is available), should have a stout copper wire soldered to one corner, the plate being buried on its edge until the upper edge is 6 in. or 8 in. below the surface of the ground.

The hole in which it is placed should be about half filled with cinders or broken coke, water should be poured in and the earth replaced and stamped down. (3) If sufficient space is available, 2 (or more) long lengths of bare copper wire, not necessarily new, may be buried some 3 in. to 8 in. beneath the surface of the ground, underneath and in line with the aerial wires. The two wires should be brought together where they emerge from the ground (as near to the leading-in point as possible), and may be joined together to form the earth lead.

Why is it that in a simple Crystal Set the current passes through the high resistance of the crystal and 'phones, instead of through the low resistance tuning coil?

It must be remembered that

although the tuning coil may have a low ohmic resistance, yet it offers a considerable impedance to currents of the frequency to which the circuit is tuned, and hence such currents produce appreciable differences of potential across its ends, which cause currents to flow in the detector circuit.

How many Valves must be used to work a Loud-speaker properly?

Naturally, the number varies with the efficiency of the receiving aerial and its distance from the broadcasting station. The following figures assume an average sized outdoor aerial, and should give a general idea of the required amount of amplification:—

Up to 10 miles, Crystal and two low-frequency valves.

10—40 miles, H.F., detector with reaction, and L.F.

40—100 miles, H.F., detector with reaction, and two L.F.

Above distances of perhaps 100 miles the four-valve combination will still serve, but an additional H.F. valve will be advantageous in many cases.

These are the minimum numbers of valves for consistent reception, without much skill in manipulation, or the use of a reflex circuit.

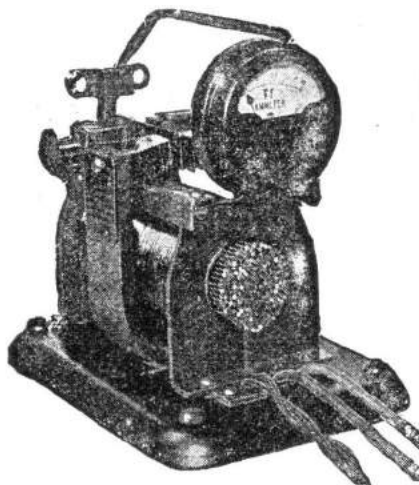

A.C. Model

Output 6 amps. 9 volts. Complete with Pole Indicating Ammeter and all connecting leads and adaptor. To standard voltages and frequencies up to 220 volts. £6 6 0

"ELLA"
BATTERY CHARGERS
They work from a lampholder.

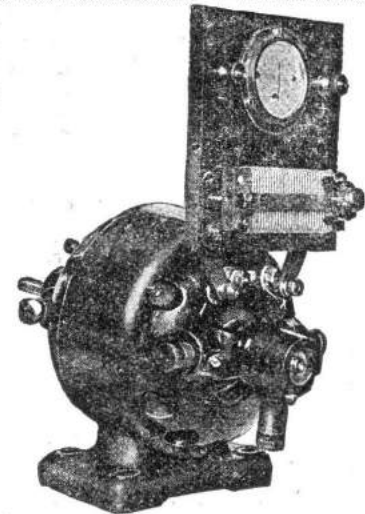

D.C. Model

Output 5 amps. 9 volts. Machine only. £5 12 6. With Switchboard Pole Indicating Ammeter and Regulating Resistance as illustrated. £6 15 0

Other voltages and frequencies £1 extra.

BATTERIES charged at home have much longer life and give better service than when charged outside.

"ELLA" Battery chargers save their cost many times over.

Write to Dept. "C" for descriptive leaflet. Trade supplied.

LIONEL ROBINSON & CO. 3c, STAPLE INN LONDON, W.C. 2

Phone: Holborn 6323 (Two Lines)

THE readers of THE WIRELESS CONSTRUCTOR will by now be familiar with the sterling value of the set designs produced by Mr. Stanley G. Rattee, M.I.R.E., Staff Editor, and many can speak from personal experience of the good results which they give. Much interest, therefore, attaches to the latest Radio Press publication, "Six Simple Sets" (Series No. 21, price 1s. 6d., or 1s. 8d. post free), which consists of a collection in a convenient book form of some of this author's most popular designs, some of which have appeared in *Wireless Weekly*, while others are entirely new. None have been published in this journal. The book contains a wide variety of extremely carefully selected designs, every one of which can be depended upon as a thoroughly practical and well-tested instrument. In Chapter I, for example, will be found the fullest possible details for constructing a very simple, cheaply made crystal set of high efficiency, which is suitable both for the ordinary broadcast band of 300-500 metres and also for the reception of the high power long wave station. There follows in the next chapter a description of a single valve receiver of a highly effective and straightforward kind,

Radio Press News
A New Constructional Book

both easy to make and simple to operate, and built entirely with ready-made components. The contents of the book are progressively arranged, passing through a two and three valve design to a quite ambitious four-valve broadcast receiver which forms the last chapter. Simple every set certainly is, but no one should be deterred from obtaining the book by the feeling that probably they have been so simplified as to be lacking in the efficiency which everyone demands in his receiver. On the contrary, the simplicity is that which results from skilful design, in the leaving out of non-essentials, the arrangement of the parts, and so forth, of each instrument in such a way that it becomes as easy as possible to handle, thus permitting even the beginner to obtain the best possible results from the set.

The four-valve set, which forms the subject of the last chapter, is one of the new designs, and possesses several distinctive features, notably a very convenient system of switching which permits any combination of valves to be used, varying from one to the full four. The switching is so arranged that the losses usually attendant upon such a system are so minimised that no one need have any hesitation in building the receiver, since truly excellent results were given by the original.

Although the book will prove very valuable to the type of reader who already possesses a certain amount of experience, and merely wishes to select one particular design from the many given, it is perhaps likely to serve best the ends of the complete novice, who might very profitably start by building himself the crystal receiver in the first chapter, and then gradually progress through the book as his experience widens, with the minimum of expense, since a design is included for a two-valve low-frequency amplifier which, although intended primarily as a power amplifier, can be regarded equally well as a perfectly standard low-frequency magnifier for addition to any of the smaller sets.

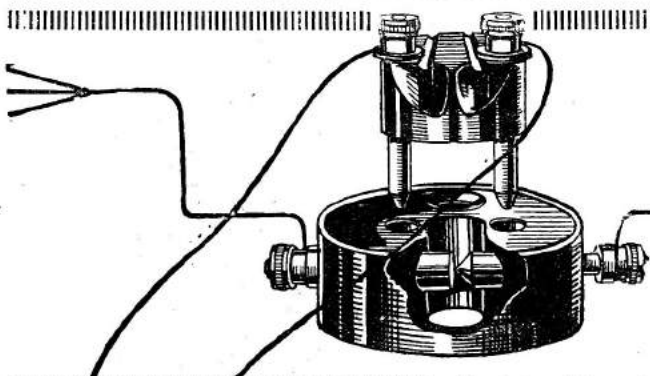

Music in every room

A Central Receiving Set (Valve or Crystal) and music relayed to every room in the house, by the simple but efficient method of

THE CRAWFORD WIRELESS JACK AND EARTHING SWITCH



The device which can be fitted in every room in the house, in an inconspicuous but handy position, fills a long felt want. These Jacks can be wired up in series from one set and tapped from any room in the house at one and the same time. Signal strength is not impaired in the slightest; the necessary wiring can be done by the most inexperienced novice. Every Wireless amateur will appreciate the advantages which this device offers, and that it is a distinct advance both from the point of view of efficiency and adaptability from anything yet offered.

PUT ONE IN EVERY ROOM

PRICE EACH 2/6

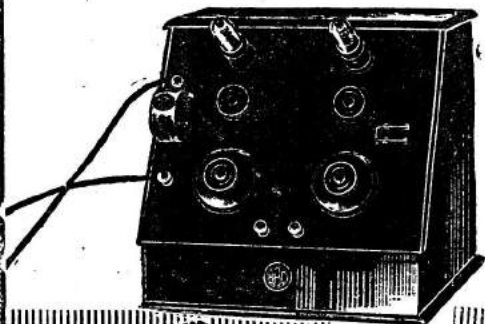

Sole Selling Agents for Gt. Britain and Irish Free State
ROMAC MOTOR ACCESSORIES LTD.

Oakley House, Bloomsbury St., London, W.C.1

In replying to advertisers, please mention THE WIRELESS CONSTRUCTOR.

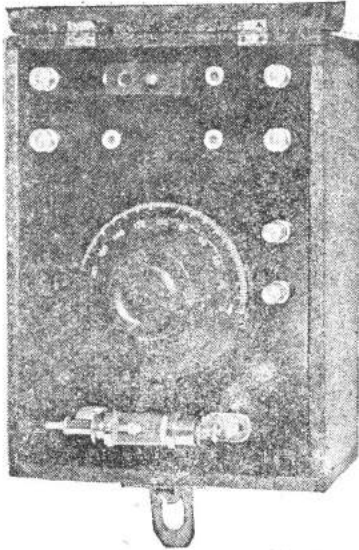

The simplicity is evident.

THIS receiver has been designed for simplicity of construction and at the same time to give the utmost efficiency as regards results. A loose coupled tuning device which is constructed on simple and rather unique lines is embodied on the set. This component is of the plug-in type which enables the operator to employ direct or loose coupling at will

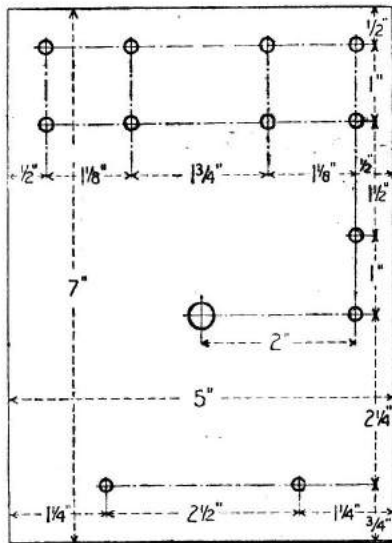

Fig. 1. How to drill your panel.

and to make quick change in the positions of the coils, and the reversing of the leads.

Material Required

- One ebonite panel, measuring 7 in. \times 5 in. \times $\frac{1}{8}$ in.
- One variable condenser .0005 μ F.
- One micro detector (Service).
- Four small pillar terminals.
- Two telephone terminals.

A Simple Loose-Coupled Crystal Receiver

By H. BRAMFORD

This article describes how to make a simple loose-coupled crystal receiver, which may be adapted in several ways

- Four Clix sockets.
- Four Clix plugs with bushes.
- Three coil plugs (K. Raymond).
- One small 4 B.A. bushed knob.
- Wood for the box.
- One set of basket coils (Ledion).

Panel Drilling

The panel, which measures 7 in. \times 5 in., is drilled as shown in Fig. 1, the necessary dimensions being given. The hole to receive the single hole mounting condenser is drilled to clear the bush of same, the usual size being $\frac{3}{8}$ in. Terminal holes are drilled to clear 4 B.A. terminal screws. Four holes are drilled to $\frac{3}{8}$ in. diameter for the Clix sockets. Four B.A. holes are also drilled for the detector.

Panel Assembly

The panel assembly is shown in Fig. 2. First mount upon the panel the four terminals marked A, A1, E, and E1. Next mount four Clix sockets marked X1 to X4. The variable condenser and detector are then mounted in the usual manner and the panel is completed with the mounting of the telephone terminals. One of the telephone terminals may be made to secure a small indicator as shown in the diagram for accurate reading of the condenser dial. This indicator may be made of any suitable substance,

A view of the receiver showing the loose-coupling coil holder.

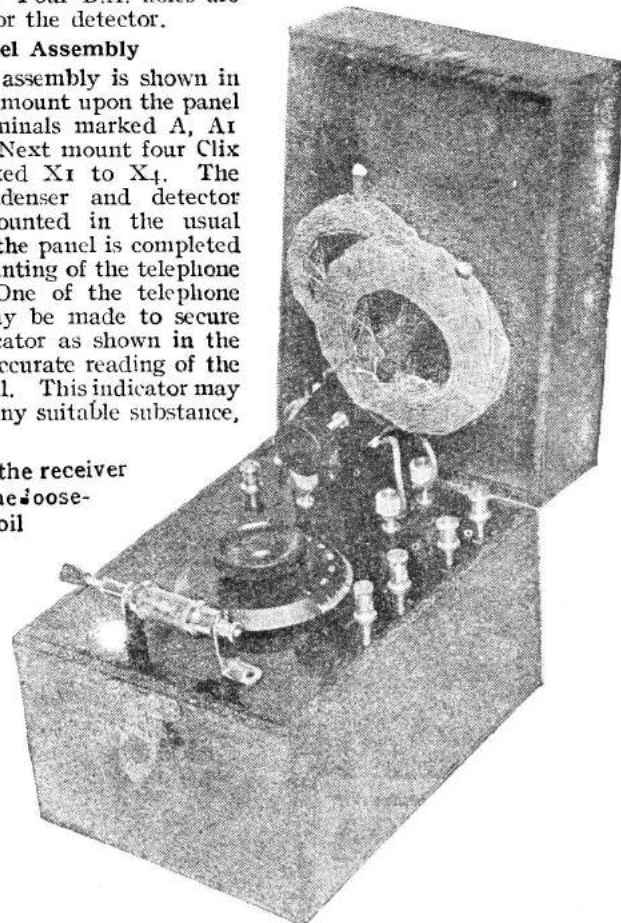

white celluloid being preferable. A coil plug is assembled to the panel between Clix sockets X1 and X2, to act as an adapter for the plug-in two-way coil holder.

Connections

The back-of-panel connections are clearly shown in Fig. 4. Terminal A is connected to socket X1 and terminal E to X2. Socket X3 is connected to terminal A1, passing from this point to the fixed vanes of the variable condenser, and on again to one side of the detector. Socket X4 is connected to terminal E1, passing from this point to one telephone terminal,

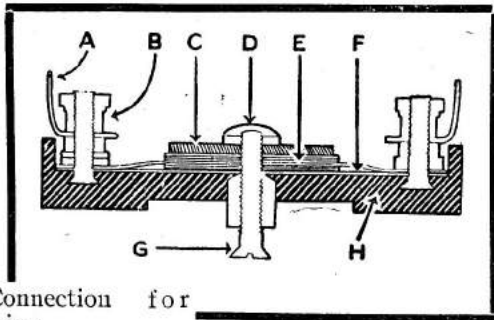

- A. Connection for Soldering.
- B. Terminal Connection.
- C. Clamping Plate, giving minimum air space and constant capacity.
- D. Guarantee Seal after each condenser has been tested for short circuit, disconnection, leakage, capacity, etc.
- E. High grade Ruby Mica Dielectric.
- F. 98 per cent. Pure Copper Plates.
- G. One-hole Fitting suitable for Panels 1/8 in. to 1/4 in.
- H. Case made of a special high Insulating Composition.

FINSTON ONE-HOLE Fixed Condensers

are the best for Amateurs and Experimenters; simple in design, but sound in construction. EASY to mount, and guaranteed capacity

Another big step forward in radio. Amateurs, experimenters, and other enthusiasts have long needed a model with the easiest fixing possible, viz., the one-hole method. Like our other components the Finston One-Hole Fixed Condenser will give the utmost satisfaction and is immune from trouble in the most exacting and protracted use

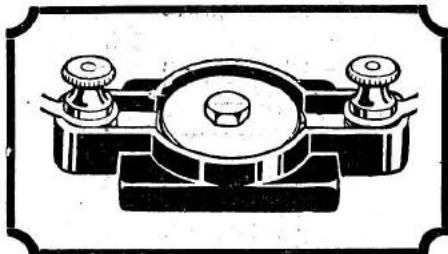

Unsolicited Testimony.
19, Milligan Road,
Aylestone Park, Leicester.
E. H. WILSON, Mem. B.B.C.
Maker of Scientifically Constructed Wireless Sets.
January 26th, 1925.
Messrs. The Lighting Supplies.
Please send at your earliest the following Finston Fixed Condensers:
6 only .0001 3 only .0002 2 only .0003
3 only .0005 3 only .001
These condensers I have found accurate and of good workmanship.
(Signed) E. H. WILSON.

Buy one—Test one. It will prove our statements and thoroughly satisfy you. Obtained from all leading stores, etc. If you experience any difficulty, communicate with us, giving your dealer's name and address

.0001 .0004 } 2/- .003 .005 } 2/6
.0002 .0005 }
.0003 .001 }
.002 }

LIGHTING SUPPLIES Co.,
2, 4, 5, Finsbury Avenue, Eldon Street, London, E.C.2
Telephone: LONDON WALL 2475.

Branches—171, Oxford Road, Manchester; 10, Grosvenor Chambers, Broad Street Corner, Birmingham. Scottish Agents—Clydesdale Supply Co., 2, Bridge Street, Glasgow; Young (Glasgow), Ltd., 40, Stockwell Street, Glasgow; A. E. Townshend, 5, Charlotte Square, Newcastle.

Write for List Z 426

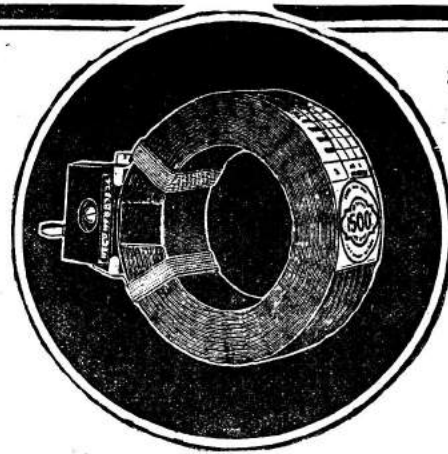

IGRANICO Honeycomb Duolateral COIL

Aerial characteristics often demand an intermediate Coil

That is why you can obtain Igranico Honeycomb Duolateral Coils in nineteen sizes, with wavelength ranges of from 100 to 23,000 metres. If you find that your 25, 35, 50, 75 or other "popular" sized coil does not give that critical tuning for which you aim, plug in one of the intermediate Igranico Coils of say 30, 40 or 50 turns as the case may be, and you will plug-in a sure way to better tuning.

IGRANICO RADIO DEVICES include:

Honeycomb Duolateral Coils, Fixed Condensers, Filament Rheostats, Intervolve Transformers, Variometers, Varlo-couplers, BI-plug Coil Holders, Tri-plug Coil Holders, Battery Potentiometers, Vernier Friction Pencils, etc., etc.

All carry a six months' guarantee, and are stocked by all reputable dealers. Write for List Z126.

Birmingham
Cardiff
Glasgow



Leeds
Manchester
Newcastle

149, Queen Victoria Street, London

Works: BEDFORD

DATA AND PRICES OF "IGRANICO" PLUG TYPE HONEYCOMB DUOLATERAL INDUCTANCE COILS

Coil No.	Self capacity micro-mfds.	Natural Wave-length metres.	Wavelength in metres when shunted by				Price
			.0001 mfds.	.0003 mfds.	.0005 mfds.	.001 mfds.	
25	25	53	117	190	243	336	5/-
30	32	72	147	233	294	411	5/-
35	37	90	174	272	344	477	5/-
40	32	104	216	335	424	590	5/2
50	38	133	252	395	498	693	5/2
60	39	157	298	464	585	814	5/4
75	38	170	326	511	644	895	5/6
100	24	220	504	815	1036	1445	7/-
150	25	333	738	1190	1520	2110	7/10
200	23	420	976	1580	2015	2820	8/8
250	24	538	1215	1960	2490	3480	9/-
300	20	608	1470	2400	3010	4280	9/5
400	16	810	2175	3585	4580	6430	10/3
500	18	956	2470	4050	5170	7240	10/6
600	18	1140	2905	4770	6100	8800	11/-
750	19	1450	3720	5950	7650	10640	11/10
1000	18	1900	4920	8090	10320	14470	12/8
1250	17	2380	6280	10320	13180	18500	14/-
1500	21	3200	7720	12580	16000	22400	15/-

Barclays 823

In replying to advertisers, please mention THE WIRELESS CONSTRUCTOR.



In Two Models:
 Grand Concert ... 30/-
 Eureka No. 2 ... 22 6
 (For Second Stage).

The Living Artiste

LOTS of people think that good suits cost too much — that a good car costs too much—that fine furniture costs too much. Yet there are people who buy all these things, and who know that they get very good value for their money.

They are just the kind of people who believe that in the building of a Wireless Set it is well worth while using Eureka Transformers. They are not necessarily well-to-do—they don't do it to impress their friends. They do it because they cannot resist the appeal of quality.

Into the manufacture of Eureka Transformers goes much care and forethought. In fact, it would not be too much to say that each Transformer

receives the individual attention that is usually accorded to expensive scientific instruments.

An incessant demand—not only from all parts of this country, but also from the Continent and from the Colonies—has certainly necessitated their manufacture on a mass production basis, but no test is too stringent and no safeguard too great to ensure the original Eureka quality being fully maintained.

As a direct result, we have yet to hear of a dissatisfied Eureka user, while the wonderful flow of correspondence from wireless enthusiasts is a spontaneous tribute to Eureka excellence, and its ability to "re-create the living Artiste."

Manufactured only by:
 Portable Utilities Co., Ltd.
 Fisher Street, London, W.C.1

From all Dealers

Scottish Agents:
 Blackie, Fuller & Russell, Ltd.
 30, Gordon Street, Glasgow

Supreme **EUREKA** for Tone

GILBERT AD, 2200

A view of the panel taken from the box showing the simple wiring.

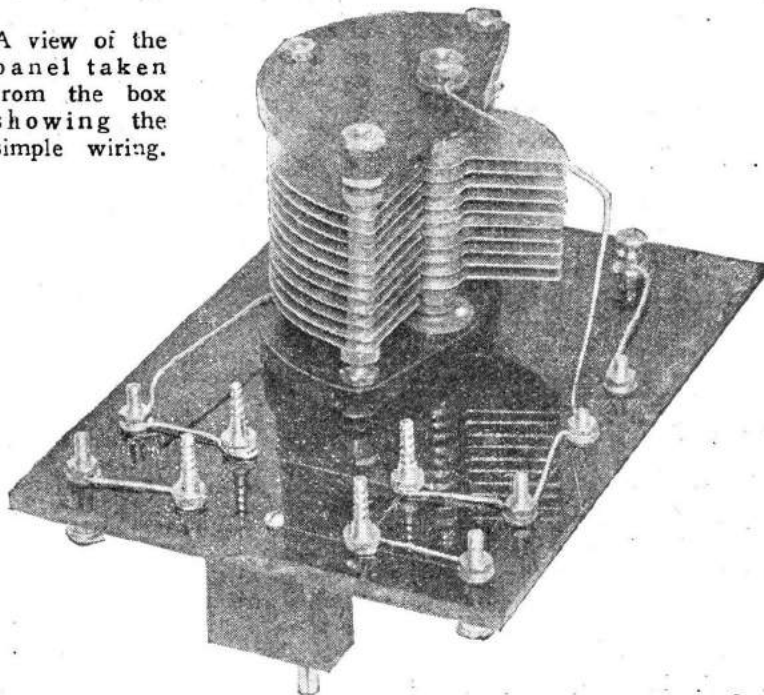

and on again to the moving vane of the variable condenser. Connections are then completed by passing a wire from the other telephone terminal to the remaining side of the detector.

Loose-Coupled Coil Holder

Details of the loose-coupled coil holder are shown in Fig. 5. This

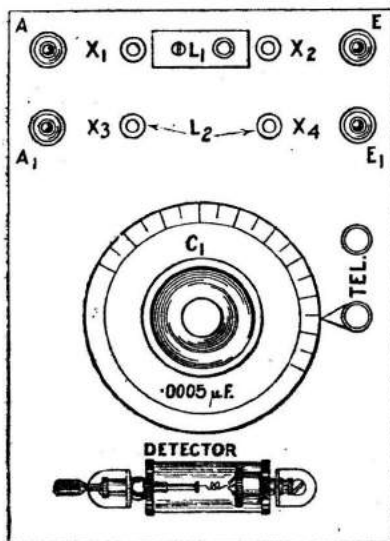

Fig. 2. This shows how the parts are mounted on the panel.

component has been made up entirely from two coil plugs, one small ebonite knob bushed 2 B.A., some round ebonite rod about $\frac{1}{8}$ in. diameter, nuts and washers, &c. First drill a hole through the

centre of one of the coil plugs to clear 4 B.A. rod. Drill a further hole in the coil plug on the under side centrally to make a tight fit for the ebonite rod coil support. Treat the other coil plug in a similar manner, but in this case cut off the projecting pin with a hacksaw. Each of the coil plugs is then equipped with two lengths of ebonite rod. The two plugs are assembled by passing a short length of 4 B.A. rod through the coil plug, from which the pin has been removed, and securing by means of nuts each side as shown, leaving a projecting length of rod for the ebonite knob. Over the other end of the 4 B.A. rod pass a spacer washer, spring washer, and washer, then slip over the other coil plug, followed by a nut and lock nut.

Flexible Leads

Four short lengths of insulated flexible wire are equipped with a Clix plug and bush, which are then secured to the four plug screws as shown. The coils, which should be of the basket type, extra air-spaced for low capacity effects, slip over the ebonite coil supports, the beginnings and endings of the windings being secured to the coil plug screws also. Having constructed the two-way coil holder, the coil holder which is provided with a pin is inserted into the coil socket on the panel. When this is done it will be seen that by rotating the ebonite knob one coil remains stationary, while the other moves radially.

Box

The box is made as shown in Fig. 7. $\frac{1}{4}$ in. thick wood has been used throughout, cutting sizes are as follows: two pieces $7 \times 3\frac{1}{2}$ in., two pieces $5\frac{1}{2} \times 3\frac{1}{2}$ in., two pieces $7\frac{1}{2} \times 5\frac{1}{2}$ in., two pieces 2×7 in., and two pieces $2 \times 5\frac{1}{2}$ in. Choice of wood and finishing is left to the taste of the constructor.

The lid is provided with two hinges and a snap lock, such as is used on attaché cases.

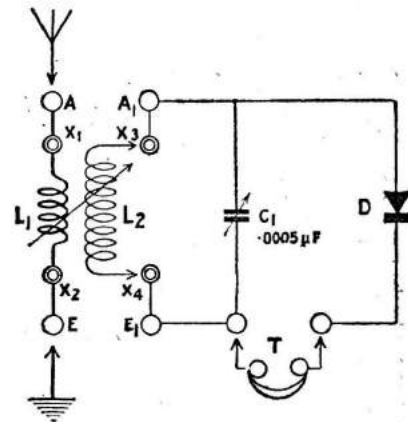

Fig. 3. The Circuit arrangement.

Circuit

The circuit is shown in Fig. 3. Where loose coupling is desired, connect the aerial to terminal A and the earth to terminal E. Plug the leads from the stationary coil L₁ into sockets X₁ and X₂, and the moving coil L₂ into sockets X₃ and X₄. Tuning is effected by means of the condenser C₁, and also by means of the moving coil. Where direct coupling is desired,

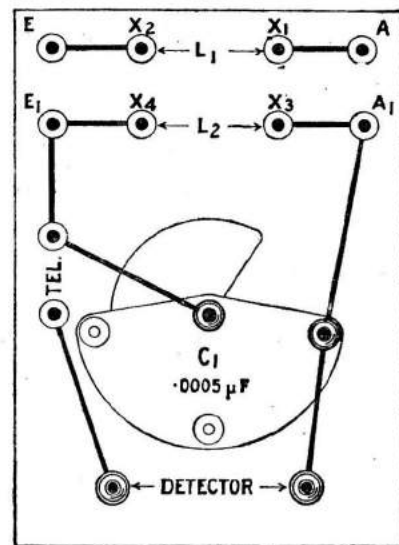

Fig. 4. Nine connections only are required.

the aerial is attached to terminal A1 and earth to E1. Either of the coils L1 or L2 being plugged into sockets X3 and X4.

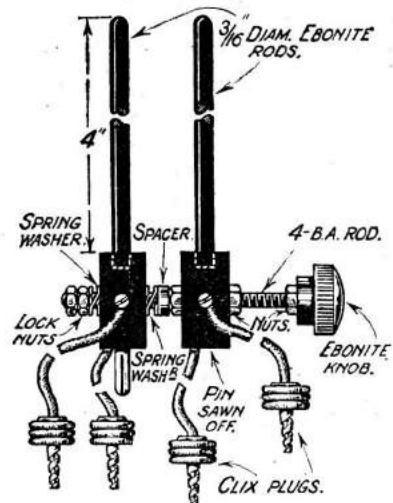

Fig. 5. Details of the coil-holder.

loose-coupled arrangement, terminals E and L1 may be joined together, thus earthing the lower end of the secondary coil L2. This may be found an advantage, and should certainly be tried.

To obtain a variometer tuning effect, connect the aerial to ter-

minal A1, plug in one side of L2 to socket X3, and the other side of L2 into socket X1. Plug one side of L1 into X1, and the other side into X4. Earth to E1.

Some Results

This receiver was tested on a small indoor aerial, and results obtained therefrom were quite good. Signals were also good using the loose-coupled arrangement, the aerial coil having about 25 turns and the secondary coil about 50

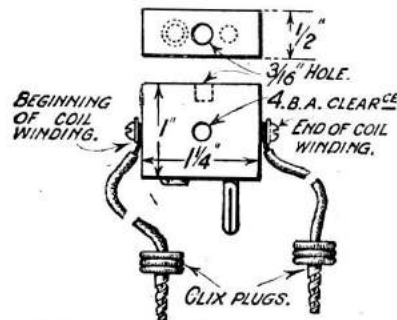

Fig. 6. How the coil-plugs are drilled.

turns. Similar satisfactory results were obtained by using direct coupling. Tuning with the condenser C1 was quite sharp.

In the hands of another member of the staff, the set was tested on an indoor, one-room aerial, loud signals being received from 2I.O at a distance of about 10 miles. Loose coupling was employed,

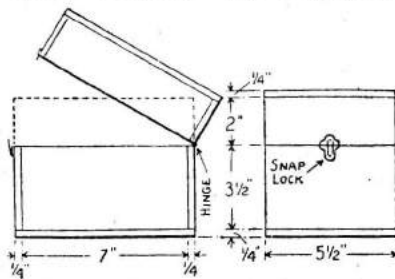

Fig. 7. How the box is made.

using a 30-turn coil in the aerial and 70 in the secondary circuit.

Chelmsford

Using a good outdoor aerial, 5 miles from 2I.O, Chelmsford was heard at good signal strength, employing direct coupling by means of a 200 coil.

2I.O was heard with considerable volume, using 40 in the aerial and 75 in the secondary circuit.

Using a 75 coil with the direct-coupled circuit, 2I.O was received without an earth connection at good strength in the telephones.

Fixed or Experimental?

A question all must answer

MANY amateurs have a little difficulty in deciding how to arrange their apparatus. Those who have a complete set in one cabinet, and who are not always changing their circuits and using new gadgets, will have no difficulty in finding a place where their sets may be permanently connected up. But in regard to the real experimenter, is he to fix all his sets and apparatus up on a bench or table permanently and screw all his switches down, so that everything has a fixed place and can be used but not rearranged? Or shall he keep everything in a cupboard and reserve a clear table to connect up just what he needs for his experiments at the moment?

The best thing he can do is to make a compromise between the two, and have a small table on which is connected up a set which is kept permanently arranged so that it may be switched on at any

time for reception from different stations, and a larger table which shall be kept more or less clear for trying out bench "hook-ups," and new sets, or for trying out new gadgets and ideas. Needless to say, the actual workshop part of his station should be kept quite

separate from his completed apparatus. Although the hints given above are very simple, and do not look of much importance, they will make the work of the experimenter much easier and keep his station much neater if carried out.

A. S. C.

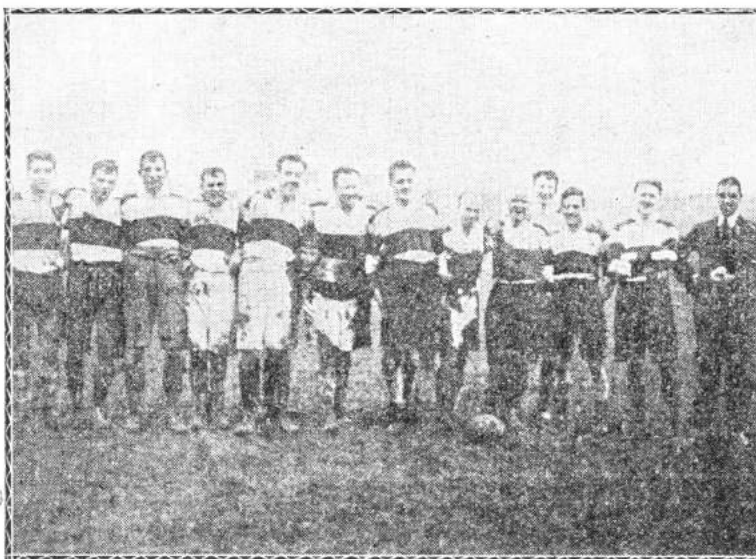

The B.B.C. have started a Rugger team. They are seen above after a game. Sixth from the left is Mr. Dan Godfrey, Jr., a leading light in the team.

'Loud Speaker Results' from your Crystal-Set

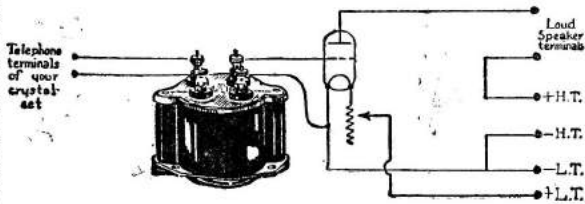

JUST the place for your "Powquip." Once in this position it will never worry you any more; it is a quiet and efficient worker—it will never growl, howl or grumble at you, like many of its fraternity, because it is made from all the best materials and of sound design. Guaranteed twelve months.

Open type, 14s. 6d. Shrouded model, 18s.

The
POWER EQUIPMENT
COMPANY LIMITED

KINGSBURY WORKS, THE HYDE, HENDON, N.W.9

SHIPTON PRODUCTS

Wireless Components produced by Shiptons represent just that increase of efficiency which means better results for you. Build Shipton Apparatus into your sets; these will give you the utmost satisfaction. Get Shipton Products from your dealer.

SHIPTON NEW TYPE STRIP RHEOSTATS

The 7-ohm Model is fitted with a fuse, which little device may save you the cost of an expensive valve. Give perfect control.

- SHIPTON New Type STRIP RHEO-STAT, 7 ohm (with fuse) .. 3/-
- SHIPTON New Type STRIP RHEO-STAT, 30 ohm .. 3/-
- SHIPTON New Type STRIP RHEO-STAT, 60 ohm .. 3/-
- SHIPTON POTENTIOMETER, 600 ohm 4/6

SHIPTON NEW TYPE VERNIER COIL HOLDER

Gives perfect adjustment. Solid Elbonite. No loose connections. 2-way price 4/-. 3-way, price 7/6. Nickel plated—2-way, price 4/6. 3-way, price 8/-. For Panel Mounting.

SHIPTON COILS

Double basket wound. Enamelled wire. A really highly efficient coil.

Size 1	100-250	.. 4d.
" 2	150-350	.. 5d.
" 3	200-450	.. 6d.
" 4	300-600	.. 7d.
" 5	400-750	.. 8d.
" 6	500-1,000	.. 9d.
" 7	600-1,250	.. 10d.
" 8	1,250-1,800	.. 1/-
" 9	1,500-2,500	.. 1/2
" 10	2,000-3,000	.. 1/4

Double cotton covered coil 2d. extra.

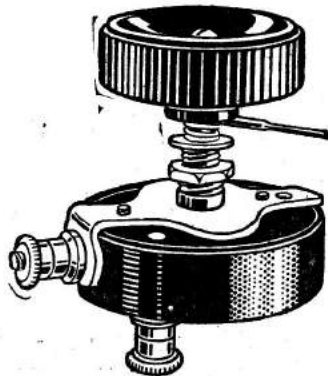

SHIPTON NEW TYPE VARIABLE GRID LEAK

FARADAY HOUR TEST REPORT T222/H. The gridleak submitted was tested for resistance at various positions of its handle, and the resistances varied continuously from 0.5 megohms to 6.5 megohms. Silent in operation. Constant under different settings. Can be calibrated accurately. Reliable under all conditions.

PRICE 3/-

If your dealer cannot supply send direct to:

E. SHIPTON & CO., LTD.
37, TOTHILL STREET, WESTMINSTER, S.W.1

Telephone—VICTORIA, 71. Telegrams—"RENTFONES, PARL"
Also at 14, King Street, Covent Garden, London, W.C.2 Trade Enquiries Invited

Barclays 817

Coils for Trap Circuits

By R. A.

Undoubtedly the best results from trap circuits recently described by Mr. John Scott-Taggart, F.Inst.P., A.M.I.E.E., can only be obtained when low-loss Coils are employed. Owing to their special design and construction the most suitable Coils to use are "EFFICIENCY INDUCTANCE COILS," manufactured by Gambrells (Fig. 1).

Below are shewn the various Gambrell Coils which should be used for B.B.C. Stations, Chelmsford and Radiola.

	Aperiodic Aerial.	Anode	Trap.	Reaction.
B.B.C. Stations	a	C	C	A
Chelmsford & Radiola	D	F	G	E

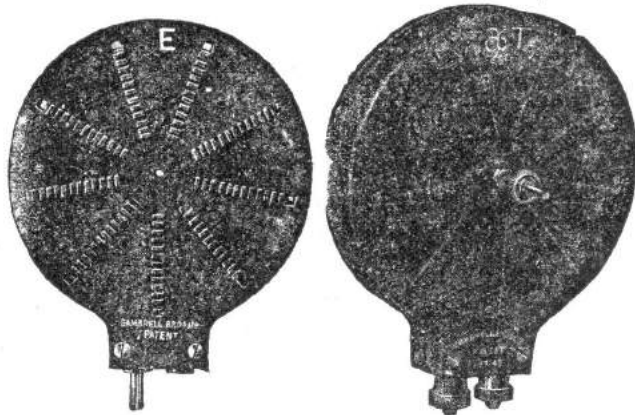

Fig. 1.—The Gambrell Coil.

Fig. 2.—The Gambrell Coil for Trap Circuits.

It is a simple matter to adapt any receiver utilising a 3-Coilholder for Trap working by plugging in Standard Coils such as above, but modifying the connections in accordance with the diagrams given in Mr. Scott-Taggart's article in the February issue of *Modern Wireless*, pages 12 to 16.

Special Coils have been designed in order that receivers utilising only a 2-Coilholder may be adapted for Trap working as simply as those with a 3-Coilholder. These Coils are special aperiodic Aerial Coils which will be called "aT" for B.B.C. wavelengths, and "DT" for Chelmsford and Radiola, and are fitted with two terminals instead of the usual plug and socket and a centre pin for clamping them to the Trap Circuit Coil, thus providing a very simple method of adapting existing receivers using Gambrell Coils to these Trap circuits.

Complete Aperiodic Aerial Coils with terminals and fixing studs (Fig. 2):—

aT ... 6s. 6d. DT ... 8s. 9d.

Advt. of Gambrell Bros., Limited, 76, Victoria Street, London, S.W.1.

TELEPHONE: Victoria 9938. WORKS: Southfields, S.W. from whom leaflets may be obtained giving fullest information of their well-known "Efficiency" Inductance Coils.

How to Add Grid-Bias to Your Note Magnifiers

An interesting article which shows how to get the best out of an existing receiver

IN last month's issue of THE WIRELESS CONSTRUCTOR there was described, on page 397, an easy method whereby an extra H.T. voltage may be added to the note-magnifying valves of a commercially or home-made receiver fitted without the facilities for using a power valve and using the same circuit there will be found below a simple method whereby grid-bias may be added.

Firstly, it may be found that upon adding the extra H.T. voltage as suggested in the manner described in last month's issue, the quality of the music and speech has suffered somewhat, results having become nasal and trumpet-like. The reason for this distortion lies in the fact that by adding the extra H.T. voltage we have not only increased the volume of the results, but have so arranged things that the last valve is not operating in a proper manner, or, to put it more technically, is not operating upon the most advantageous point of its characteristic curve.

Introducing the Grid Battery

Now to so arrange that we may effectively utilise the extra H.T. voltage which it permits, we must insert between the L.T. negative terminal of our receiver and that terminal of the L.F. transformer previously connected to the L.T. negative busbar a small battery

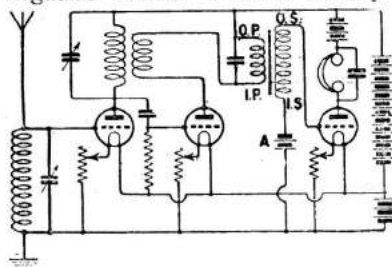

Fig. 1.—The extra battery A provides grid-bias.

commonly called a "grid" battery. In Fig. 1 is shown the same circuit as illustrated last month, but in this case the extra battery between the L.T. negative and transformer is shown at A.

The alteration whereby a receiver may be made to comply with these conditions is a little more difficult

than was the case when adding the extra H.T. battery, in that the connections which have to be made affect the internal wiring of the receiver.

The First Operation

The first operation is to remove the panel from the containing box, when upon examination of the under side the connections as shown in Fig. 2 will be seen. The second operation is to remove the wire which connects the L.T. negative to the transformer secondary, and by some means or other to connect a lead from the grid battery positive to the L.T. negative, and from the grid battery negative to the terminal of the secondary of the

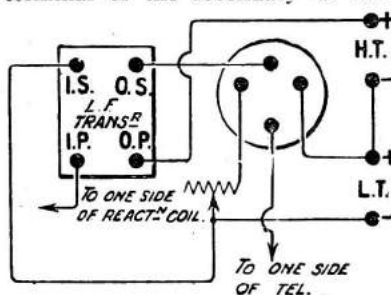

Fig. 2.—These connections are as found in the set.

transformer, but since we do not yet know what voltage will be required a little more thought upon the subject is called for. The most satisfactory manner in which to add grid-bias to an existing set is to find upon the panel at some convenient place sufficient room to permit the fitting of two extra terminals, to which may be connected *externally* a grid battery of suitable voltage according to results.

Assuming that these two terminals have been fitted, and usually there is at least *one* place where they may be added, the connections on the under side of the panel are as shown in Fig. 3, X and Y representing the extra terminals. When the wiring has been completed it should be noted which terminal goes to the L.T. negative (Y in Fig. 3), and the terminal should be marked "plus" on the upper side of the panel; similarly the other terminal (X) may be marked negative or "minus." With this work completed we may replace the panel upon the box, make all exter-

nal connections as before and proceed in the following manner to rid the set of the distortion resulting from the use of the extra H.T. battery.

To the two terminals just fitted to the set connect two short lengths of flexible wire, each with wander plugs attached, one red, one black, the lead with the red plug going to the positive terminal, and the lead with the black plug going to the negative.

Procure from practically any wireless dealer a grid battery of 9 volts, fitted with tappings similar to those seen on H.T. batteries, and insert the red plug previously referred to into the positive of the battery and the black plug into, say, the 3-volt tapping.

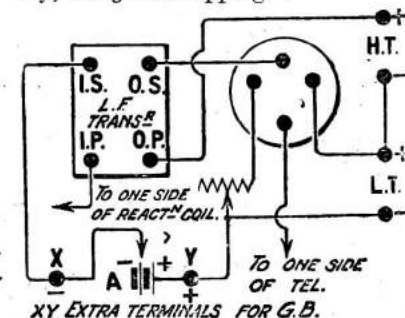

Fig. 3.—Showing how the extra terminals are to be joined in circuit.

Upon starting up the set to give the loudest results, it will be found that much of the distortion which was previously noticed will have disappeared, or else will do so upon changing the position of the black plug to other tappings of the grid battery.

When the Battery Wears Out

Should the grid battery at any time become exhausted through deterioration or accidental short-circuiting, then, until a new battery is procured the two terminals across which it would normally be connected should be joined together by means of a piece of wire.

S.G.R.

Test Department

The popularity of this department has necessitated greatly increased staff, and while it is not intended that the department should pay for itself, this fact together with the high cost of the necessary standard testing instruments compels us reluctantly to increase the cost of testing to 5/- per valve in a "straight" receiver, 10/- being charged for a "dual" valve. In addition, we cannot undertake to test any set in which a departure from Radio Press design has been made :

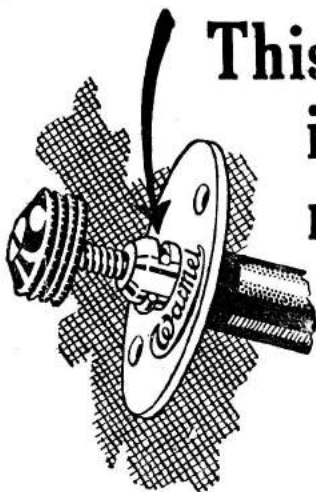

This refinement improves reception

Those experimenters who favour the use of the variable grid leak appreciate how it gives the final touch—clearing reception to make it rich, pure and round in tonal quality. The WATMEL is well known as the first variable grid leak which became available to the home constructor, and its consistent record for reliability to get the best out of the detector valve is without compeer.

Recessed into the collar a D shape spring presses firmly upon the controlling plunger. This device—truly a refinement which improves reception—ensures after constant use that the essential contact is always maintained electrically good.

WatMel

All goods of our manufacture bear this mark. It is your only guarantee.

If you are troubled with poor results pay particular attention to the working of the Detector Valve. Reduce the H.T. voltage consistent with good volume and incorporate a WATMEL Variable Grid Leak.

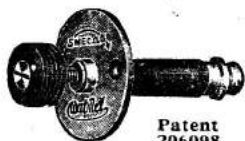

Patent 206098
5 to 5 Megohms .. 2 6
50,000 to 100,000 Ohms 3 6

Send P.C. for Descriptive Folder
When at your dealers'
SEE THE TRADE MARK

WatMel

ON EVERY GRID LEAK
BEWARE OF IMITATIONS

WARNING

It is the aim of this Company to protect traders' customers' and also its own interests by securing Patent protection for the novelties in its specialities. It is these novelties, invented by experts and exhaustively tested, which are the Hall Mark of all Watmel Products.

The Watmel Wireless Co. wish to notify the trade and public that their Variable Grid Leak Patent Application No. 206098 was contested in the Comptroller's Court, and on appeal; in both instances the Patent Grant was upheld and costs awarded.

The WATMEL WIRELESS CO. LTD.
332a, Goswell Road, LONDON, E.C.1

Telephone CLERKENWELL 7990

Barclays 797

DON'T BE PUZZLED

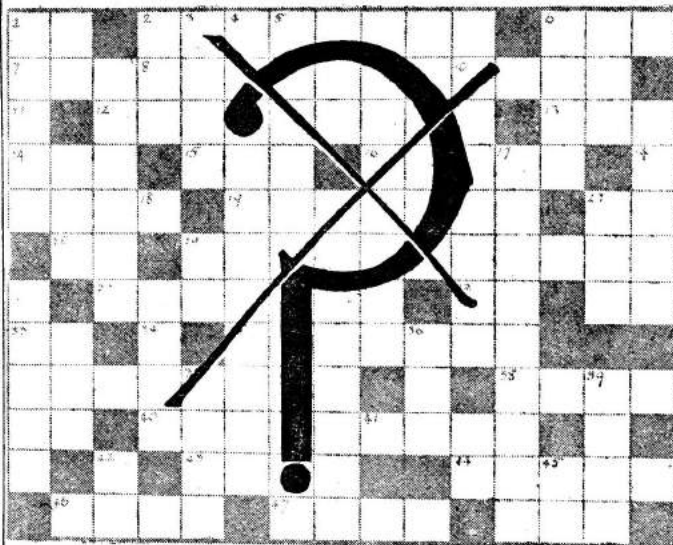

THERE IS NO QUESTION

ULTRA

REGISTERED TRADE MARK

LOUD SPEAKERS

ARE THE BEST

ASK YOUR DEALER FOR THEM

Should you have any difficulty in obtaining same, write direct to

27/6

Messrs. EDWARD E. ROSEN & CO.,
158-160, City Road,
LONDON, E.C.
with the name of your Dealer

WRITE FOR OUR ILLUSTRATED PAMPHLET

The Aerial You Have Been Looking For!



"Strong as Steel"

MAGNIPLEX is made of specially woven Phosphor Bronze Wire Gauze of high tensile strength and conductivity, and can be used in any form of aerial.

Prices:— $\frac{3}{4}$ in. wide 3d. per foot; $\frac{1}{2}$ in. wide 2d. per foot. Supplied in lengths of 25, 50 and 75 feet including fittings, viz:—End Terminal for Down Lead and Insulators ready for erecting. For lengths under 25 ft. fittings charged 1s. 3d. extra. Postage and Packing paid.

Our claim is backed by a guarantee that we will refund your cash without question if results are not better than your present aerial and more than justify the extra cost

HELIXO LTD.,
HENRY BUILDINGS, GRESLE STREET, RATHBONE PLACE, LONDON, W.1.

Phone: Museum 6039.

Patents applied for.



GRAFTON WIRELESS HOSPITAL—A CASUALTY

—IS YOUR SET QUITE FIT?

Maybe it has gone "off colour" a bit lately. It's not too bad, but you think it could be better. Don't know just what is wrong! The other day you could get heaps of stations, but now . . . Or again, perhaps the whole contraption requires overhauling, and you're not a technical expert! We have a special department where your case will be diagnosed by qualified experts, who will quickly return your set tuned up to the maximum efficiency. The charge is extremely modest. Bring or send your set, and we will quote for restoring to complete health.

TWO COMPONENTS FOR HOME CONSTRUCTORS.
Volt and Ammeters.

Small current consumption, and of highest quality throughout. N.P. and polished case, accurately calibrated. Dial 2 1/2 in., back flange 3/4 in.

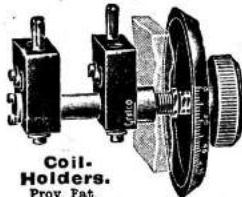

Coil Holders.
Prov. Pat.
A splendidly designed article for panel mounting. Smooth and true movement, with handsome knob and dial. Price 5/6.

	s. d.
0.10 volts ..	9 0
0.20 " ..	9 6
0.30 " ..	11 0
0.60 " ..	14 6
0.3 amps. ..	9 6
0.10 " ..	9 0
0.20 " ..	9 6
0.30 " ..	11 0

All ranges in stock.
Post 3d.



Get instructive 72 page catalogue just published—send for copy.—Post free 3d.

Telephone: MUSEUM 201

Works: SLUGH



54, GRAFTON STREET,

LONDON.

TOTTENHAM COURT ROAD,



Another Guaranteed
BRETWOOD Speciality
is our improved
ANODE RESISTANCE

BRETWOOD GRID LEAK
Patent No. 224295
Successfully used and recommended everywhere.
Price 3/- Postage 3d.

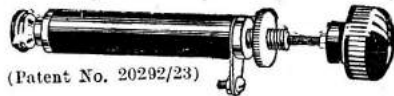

(Patent No. 20292/23)

BRETWOOD PATENT VALVE HOLDER
Fix this efficient component and get maximum results. Positively no leakage or capacity effects. Perfect contact. Can be mounted on front or back of panel.
Price 1/9 Postage 3d.

which gives accurate readings consistently from 10,000 ohms to over 100,000 ohms. This BRETWOOD Component is particularly suited for the ST100 circuit (*Modern Wireless*), the super-sensitive circuit (*Popular Wireless*), and for resistance coupling, etc.
It is constructed on the same principles that have made BRETWOOD Components famous, and, of course, it carries the BRETWOOD Guarantee. Price 3/- Postage 3d.

BRETWOOD ANTI-CAPACITY SWITCH

Bretwood Specialities are known throughout the wireless world to be the last word in scientific achievement, and constructors will welcome news of a further Bretwood Product, an Anti-Capacity Switch, the principal features of which include:—

Absolute freedom from capacity effects—Perfect Contact—Workmanlike finish and neatness of appearance—Simple single-hole fixing and Easy to make wiring connections. Special spring loaded balls in the base make the Bretwood Switch wonderfully smooth in action and ensure PRICE clean and perfect electrical contact at all times. It is confidently offered to wireless constructors as the Anti-Capacity Switch *par excellence* and of course it carries the famous Bretwood Guarantee. Post. 3d. **5/-**



BRETWOOD LTD.
12-18 London Mews, Maple St., London, W.

All Bretwood specialities are obtainable from most Wireless Dealers

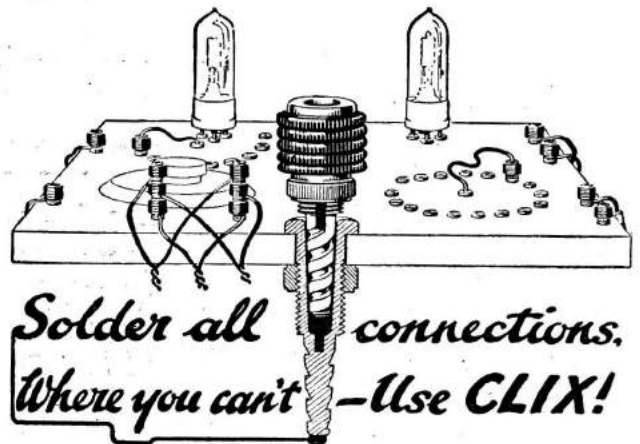

Solder all connections.
Where you can't — Use CLIX!

CLIX PROVIDES AN IDEAL POINT FOR SOLDERING

Retail Prices—
CLIX with Locknut 3d.
CLIX Insulators
(6 colours) 1d. each
CLIX Bushes
(6 colours) 1d. pair

Perfect contact—instantaneously—everywhere.

The tapered design of CLIX plugsocket ensures full surface contact in every one of its countless applications.

That's why CLIX, the Electro-Link with 159 uses, supersedes all forms of Plugs, Terminals and Switches, and has standardised the wiring of all radio circuits.

Obtainable from all Wireless Dealers or direct from the Patentees & Manufacturers

AUTOVEYORS, LTD.

Radio Engineers and Contractors

84 VICTORIA STREET, LONDON, S.W.1



COMPONENTS
— for efficiency

An efficient Set depends upon reliable and soundly designed Components. Build your set with Efesca One-Hole-Fixing Components; they are made with the highest degree of accuracy and include many patent features of great value.

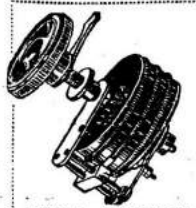

EFESCA VERNISTAT
(Patent)
The most efficient and delicate filament control for H.F. and Detector Valves. Resistance 5 ohms. **5/-** each



ONE-HOLE-FIXING COMPONENTS

Send us a P.C. to-day for Catalogue 522-11
WHOLESALE ONLY—
FALK, STADELMANN & CO., LTD.
Efesca Electrical Works,
83, 85, 87, Farringdon Road,
LONDON, E.C.1
And at Manchester, Birmingham and Glasgow



EFESCA ANTI-CAPACITY SWITCH
The design of this double pole, double throw switch eliminates capacity. Use this switch in circuits when capacity effects are fatal to efficiency.
Price **8/-** each

MAKE YOUR OWN CABINETS

We supply timber cut accurately to size for amateurs to make their own cabinets. Every part is ready for immediate assembling. Amateurs who use these parts will not have cabinets that look amateurly made, out of square and with jagged edges. Each part is planed smooth, sawn square, and fits accurately.

Prices for Stock Sizes of Cabinets

Cabinet.	Parts per Cab. made up	set.	and polished
6 x 6	1/9	3/-	
9 x 8	3/-	6/-	
10 x 9	4/-	7/-	
12 x 10	5/-	8/-	
14 x 12	6/-	10/6	
16 x 12	7/-	12/-	

All postage 9d.
 Stopping Cabinets 50 per cent. on these prices.
 Ask for quotations for special sizes. Nothing but the best oak or mahogany is used.

Depth of Cabinets 6 inches.
F. & J. FLETCHER, Ordish Timber Yard, Water Lane, Halifax, Yorks.

PARIS AND OTHER STATIONS

clearly heard on Loud Speaker near London, using the "MIRACLE" MASTER 2 Valve Set, £3 12s. 6d. plus Royalties. 1, 2, 3 & 4 Valves. Trade supplied. Send stamp for particulars.
WORLD'S WIRELESS STORES, WALLINGTON.

YOUR CABINETS

The original House for hand-made and polished Mahogany, Oak and Teak Cabinets to customer's own design. All Timber used in my cabinets is carefully selected and guaranteed THOROUGHLY seasoned.

AN APPRECIATION.

London, E.C. 3.
 To Messrs. W. H. Agar,
 19, Whitecross Place, E.C. 2
 27th Feb., 1925.

Dear Sirs,
 I am not in the habit of writing testimonials, but the waxed teak case you have just made for me deserves one—both as to quality, accuracy and price.

Yours faithfully,
 R. H. B.

YOUR PANELS

Finest quality 1/2 in. thick Ebonite cut to size and fitted, 3d. per square inch. This Ebonite is guaranteed British Made to Post Office Grade "A" Specification, which is the best for wireless purposes. It is rich black in colour, takes a brilliant polish, can be threaded with ease, and possesses a high degree of mechanical strength.

W. H. AGAR

Manufacturer of Telephone & Radio Apparatus.
 Tel: London Wall 3305
 19, Whitecross Place, Wilson Street, E.C.2

Fit a Malone

to your 'Phone
 and get results rivalling a
50/- LOUD SPEAKER

FOR ONLY 7/6 POSTAGE 1/-

Fitted in a second, sound British made, complete, strongly packed. Send P.O. 8/6 at once and listen in comfort. Send stamp for free descriptive Leaflet C.

Write direct to Works—
MALONE & CO., LEICHTON-SEA, ESSEX



(2,000 ohms.)

**TRUEMUSIC
 MINOR
 Loud Speaker
 21/-**



T. M. C. No. 2A Headphones
 4,000 ohms, 19/6



T. M. C. No. 3 Lightweight Headphones.
 Weight 6 1/2 ozs.
 4,000 ohms 22/6

Finished outside in nigger-brown, with copper-plated terminals, the "TrueMusic Minor" is one of the most pleasing and attractive on the market. The inside of the horn is of lacquered copper, giving a bright and cheery effect—yet it does not need polishing.

Ask to see the "TrueMusic Minor" Loud-Speaker at your favourite Wireless Shop. Its performance will delight you.

The "Minor" reproduces all kinds of Broadcasting perfectly. It will do full justice to the most elaborate set, and will get the best out of a small one.

All the family can enjoy Broadcasting for the cost of one pair of 'phones.

For "D X" working or crystal sets, T.M.C. Headphones are just what you want; sensitive and clear-toned. They are comfortable to wear, and absolutely reliable.

Remember that all T.M.C. apparatus carries a twelve months' guarantee.

LOUD SPEAKERS	
TrueMusiC Minor	£1 1 0
TrueMusiC Junior	2 10 0
TrueMusiC Standard	5 0 0
TrueMusiC Concert Grand	6 10 0

"BRITISH MADE BY BRITISH LABOUR"

T M C

The Telephone Manufacturing Co., Ltd. (Makers of the famous Laryngaphone)
 Hollingsworth Works, West Dulwich, S.E.21.

E.P.S.210

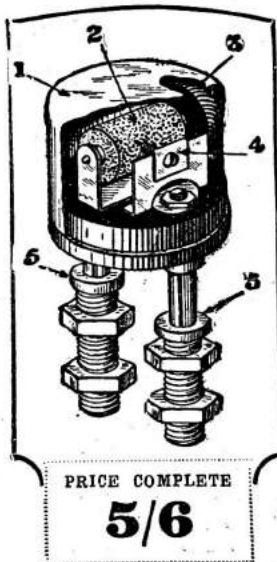

Don't tickle the Crystal—use

Harlie

FOOL-PROOF
DETECTOR

(Provisional Patent 26791/24)

Continuous reception in any position at all times, owing to the special design of both crystal and catswhisker always in contact. Guaranteed Tone—Volume—Purity

SOME NOVEL FEATURES

1. Nickel-plated, detachable, dust-proof cover.
2. Special "Harlie" super-sensitive crystal.
3. Ebonite wheel for rotating crystal. No fumbling about adjusting, just turn the wheel—simplicity itself.
4. Catswhisker on slider for covering whole surface of crystal. Shock-proof.
5. Nickel-plated sockets for panel mounting.

PRICE COMPLETE

5/6

Obtainable from all dealers or direct from Patentees and Manufacturers

GENEROUS TRADE TERMS.

HARLIE BROTHERS

183, DALSTON LANE, HACKNEY, LONDON, E.8

Telephone: CLISSOLD 293

Barclays 809

The "MELITZA" CRYSTAL

GUARANTEE—

We guarantee each piece of MELITZA Crystal to have been tested to have received Broadcasting over no less than 40 miles on average set and aerial.

The Crystal which will withstand heavy currents such as needed in Reflex Circuits.

The Crystal which is exceptionally sensitive throughout.

The Crystal which you can handle as you like.

Obtainable from all reputable retailers. If any difficulty, send 1/6 to the sole manufacturers.

Trade can obtain from leading factors—Brown Bros., etc. Most liberal trade terms.

Each piece supplied with fine quality catswhisker, in dust-proof box with transparent top. Price **1/6**



The MELITZA RADIO Co., 405, Holloway Rd., LONDON, N.7

Barclays 833

The BRITISH BROADCASTING Co., Ltd.,

have set a splendid example of Service. We are trying to follow in their footsteps.

Can we be of service to YOU?

ADVICE — QUOTATIONS — QUICK DELIVERY
PANELS DRILLED FREE—RELIABLE GOODS ONLY
Any type of Valve Set made to Order

Specimen Price: 3 VALVE SET (H.F., D., & L.F.) in Cabinet, Vertical Panel, Best Component Parts throughout - - - **£7: 0: 0**

Marconi Tax £1: 17: 6 extra

Or Complete with Valves, Coils, Accumulators, etc. - **£14: 10: 0**
No extras

WALTER E. REYNOLDS,
4, SOUTH STREET, FENTON, STAFFS.

Telephone: HANLEY 1405

Member Firm of B.B.C.

SOLDERED JOINTS SUPERSEDED!

You can easily connect up the most complicated set entirely without use of solder by using the new

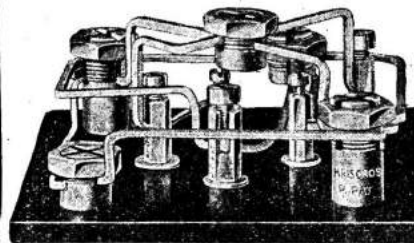

"KRISCROS" CONNECTORS

Strong and perfect joints. Used by Mr. Percy W. Harris and other leading experts. A "Kriscros" for every standard thread.

Prices: 1/6 to 3/- per doz. Send for List.

Kriscros Co., 50, Gray's Inn Road, W.C.1



Safe!

If you use the super-sensitive GIL-RAY CRYSTAL you are SURE of the very best results. Price 1/6, of dealers everywhere. If unobtainable send 1/6 and name and address of dealer to:—

The GIL-RAY Radio Co., Sicilian House, London, W.C.1. Stocked by best factors and V. Zeitlin & Sons, 144, Theobald's Road, W.C.1.

Agents for Ireland: Pettigrew and Merriman, 122, Tooley Street, S.E.1.

SEND

£1 Only

Send 20s. to-day, together with your order for the "Tonophone" and this wonderful set, which receives all B.B.C. stations, will be delivered complete, including all accessories. You pay a further £1 each month afterwards. The total cost is only £15 9s. or, if you prefer, £14 5s. cash.

"TONYPHONE" Super 2-Valves

Complete with accumulator, 11 T. Battery, aerial, 1 pair 2000 ohm headphones, and two valves—one High Frequency and one D. detector. All Royalties paid

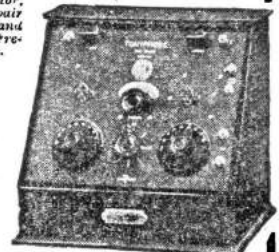

Send to-day and enjoy broadcasting NOW.

BRITISH ENGINEERING PRODUCTS CO.

(Battery Dept.), WINDSOR HOUSE VICTORIA STREET LONDON S.W.1

S.S.A.

"FAMA" THE SUPER VALVES

"FAMA" DUTCH VALVES are GUARANTEED to be the CHEAPEST, MOST EFFICIENT & MOST RELIABLE VALVES EVER OFFERED to the PUBLIC

- TYPE, TUBULAR Detector 4 volt. Amps. 5 4/3
- do. "R" Amplifier 4 do. do. 5 4/3
- 0-03 DULL EMITTER 2 do. do. 0-06 12/6
- BUY THE VALVES WITH A REPUTATION
- 60 Volt High Tension Batteries. Tapped every 3 Volts. 6/9 each.
- Adjustable Diaphragm 4000 OHMS Head-phones. 10/6 pair

DON'T DELAY. WRITE TO-DAY.
LIBERAL TRADE DISCOUNTS.

H. D. ZEALANDER & Co. (Dept. C.)
St. John's House, 124-127, Minorities, London, E.1
Phone: Avenue 1482. Postage Extra

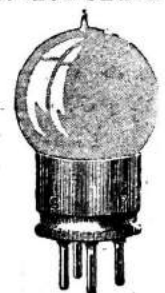



Take the WORRY out of Wireless

CONTENTS OF COMPLETE SET

- 8 Terminal Studs
 - 6 Multi-Connectors
 - 4 Coloured Connectors
 - 8 Discs (Black, Red and Blue)
 - Phones + High Tension + High Tension - Low Tension + Low Tension - Earth Aerial
- Complete with instructions.

When you build up your set—or re-wire it with Newey Snap Terminals—you straight away take all the small worries out of wireless. With a slight pressure of the finger perfect contact is made and any number of headphones can be coupled together, one above the other, on the same connection.

Experimental sets can be easily built up and changed time after time with Newey Snap Terminals, obviating as they do the mess and uncertainty of wiring not perfectly soldered.

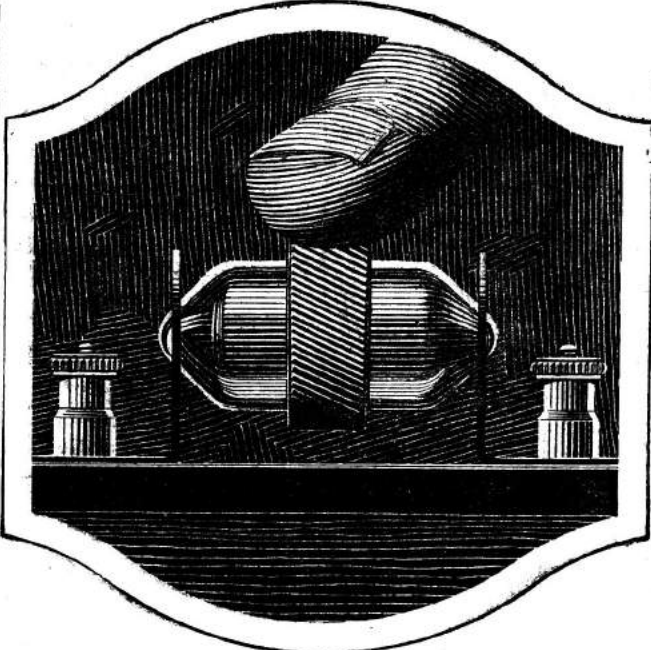

The last Detector you'll ever need to buy

HERE is an entirely new type of Crystal Detector which finally abolishes all the worry and trouble of catwhiskers. Merely rotate it with a flick of the finger and a new contact is made internally. The Gravity must not be confused with a semi-sensitive permanent detector in which the catwhisker is sealed in contact with the Crystal.

the Crystal and make contact with it at just the right pressure.

It is delightfully simple to use. Merely rotate it slowly and a continuous series of contacts is made. All that you have to do is to give it a turn until you receive the loudest signals.

The Gravity Detector consists of two cones separated by an ebonite ring. One holds the Crystal in position and the other contains around its internal periphery a row of metal points, each one of which is loaded at its head. As the Gravity is rotated these pins fall down upon

And, remember, the Eureka Gravity can be instantly removed from its clips and a new crystal inserted. No soldering or even screwing together. It will last a lifetime, for there are no parts to wear out. It is manufactured by the makers of the Eureka Transformer—a guarantee of excellence in itself.

TROUBLE FOR EVER

The RAP Patent 3-way Universal Tuning Coil Holder has the **LOWEST SELF CAPACITY** of ANY 3-way coil holder yet marketed.

if you do not eliminate Self Capacity

- WE CHALLENGE CONTRADICTION.**
- Immediate coupling of the two outside coils; tight or loose coupling of any two circuits; reverse of reaction.
 - 3-way, as illustrated - 8/6
 - 2-way universal - - 6/9
- Postage 4½d

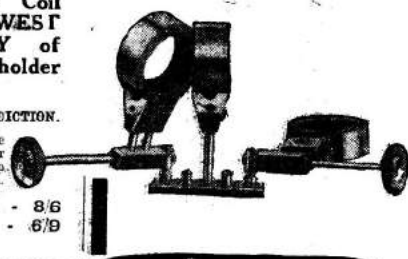

Indispensable to Experimenters.

Both moving coils can be completely reversed. The R.A.P. will take the heaviest of coils, and can be mounted in any position. No rubbing or sliding contacts. No springs, gearing, or switches to get out of order. The PIVOTING movement also gives a gradual reverse over reaction and a VERNIER control to better advantage than the mechanical adjustment installed in the ordinary movement of vernier coil holders.

R.A.P. INSTRUMENT CO.
136 Sandringham Road
LONDON - - E.8

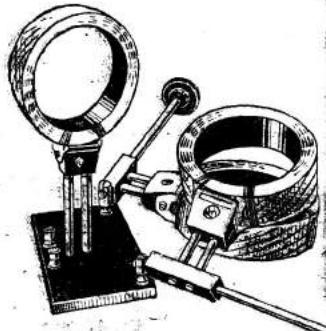

Patented and Registered Design.
27057/24
Earlclays 818

Exclusive Gravity Advantages

1. The Crystal is firmly held in a spring cup and the moving points fall to make contact with it as the holder is rotated
2. When the Gravity Detector is in use the Crystal is fully enclosed and protected from dirt.
3. The Gravity Detector can be re-loaded with a new crystal in a moment. Nothing to unscrew or solder.
4. The slightest turn of the Detector automatically brings into use a new spot on the Crystal and a new contact point.
5. Nothing to wear out—the Gravity Detector will last a lifetime.
6. Stout plated spring clips are supplied and the base can be removed for fitting the Detector direct to the panel.

Complete with tested Crystal **6/6**

From all Dealers



Manufactured only by
Portable Utilities Co., Ltd.

Fisher Street, London, W.C.1
Gibbet Ad. 2285

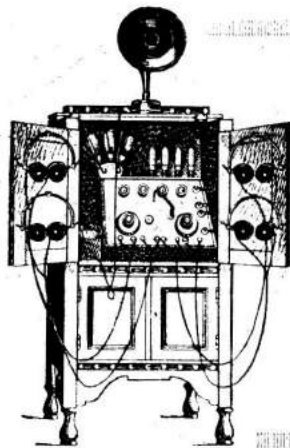

**A HANDSOME
PIECE OF FURNITURE**

**Solid Oak Standard
Cabinet with Locks**

in which to lock up or build large panel receivers, such as:

4-Valve Family. All Concert-de-Luxe. Transatlantic IV and V. Wireless Magazine 4-Valve Receiver. Anglo-American 6, 3-Valve Dual, etc.

Write for full particulars. Willingly sent on approval against remittance Guaranteed first-class workmanship.

Immediate delivery

TRADE SUPPLIED.

Price: 22 1/2 in. inside width .. **£4 10 0**

24 .. **£4 15 0**

36 (model de luxe) made to order.

Part carriage and packing 7/6 extra.

M. VERSTRAETEN
(Dept. 20) Melvill Chambers,
50a, Lord Street, Liverpool

Stop that leak!

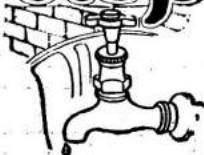

HIGH-FREQUENCY currents have a habit of leaking away just where they are not wanted. A spot of moisture—a bit of surplus fluxite—a surface polished by metallic methods—these are some of the causes of leaky panels. Even an expert cannot tell by looking at an ebonite panel whether it is leaky or not—what chance, therefore, have you?

The only safe way of knowing that your next Set won't lose signal strength is to see that you are using a *guaranteed* leak proof ebonite such as "Red Triangle" Brand.

Every sheet is tested by us for leaks with special electrical measuring instruments, and every one not coming up to our standard is rejected.

If your own Dealer cannot supply it send us your order direct and we will despatch by return of post. Don't prejudice the working of your new Set by using something that looks like ebonite when you can get really high-grade material from us at no greater cost. All panels sold only in sealed envelopes.

12 STOCK SIZES:

6 x 8, 3/-	7 x 10, 4/3	8 x 12, 6/-	12 x 14, 10/6
6 x 18, 8/-	8 x 6, 3/-	10 x 12, 7/6	12 x 16, 12/-
7 x 5, 2/3	8 x 10, 5/-	10 x 24, 15/-	12 x 18, 13/6

All 1/4-in. Thick. Sold in Sealed Envelopes.

SPECIAL SIZES:

All Concert-de-Luxe, 16 x 8 x 1/4 .. 8/-	Resist-flux, 12 x 8 x 1/4 .. 6/-
Transatlantic V., 22 x 11 x 1/4 .. 15/-	Anglo-American, 36 x 9 x 1/4 .. 20/-
All Britain, 16 x 9 x 1/4 .. 9/-	Neutrodyne Tuner, 12 x 10 x 1/4 .. 7/6
S.P. 100, 12 1/2 x 9 1/4 x 1/4 .. 7/-	Neutrodyne Receiver, 12 x 10 x 1/4 .. 7/6
Puriflex, 14 x 10 1/2 x 1/4 .. 9/2	3-Valve Dual, 24 x 10 x 1/4 .. 15/-
Transatlantic IV., 16 x 8 x 1/4 .. 8/-	Harris Crystal Set, 9 x 5 1/2 x 1/4 .. 4/4

Any Special Size Cut per return at 3d. per Square Inch

Use

Red Triangle Ebonite

PETO-SCOTT Co., Ltd.
Registered Offices, Mail Order & Showroom,
77, CITY ROAD, LONDON, E.C.1

BRANCHES: LONDON—62, High Holborn, W.C.1
PLYMOUTH—4, Bank of England Place
LIVERPOOL—4, Manchester Street
CARDIFF—94, Queen Street
WALTHAMSTOW—230, Wood Street

P. S. 2298



Stop fiddling

Don't waste time in trying to find a live spot on the crystal. To ensure clear and perfect reception instal the world-famed **TALITE (1/9)** or **H.H.F. Super HERTZITE (1/6)** Crystals, which are all active, super sensitive, and miss nothing. **Every piece tested and guaranteed.** Get one to-day and prove for yourself.

Look for the little glass tube with the red label. From all wireless dealers, or a specimen will be sent on receipt of remittance.

HARDING, HOLLAND & FRY, LTD.
Chemical Manufacturers and Mineralogists,
52, Queen Victoria Street, London, E.C.4

NEW MODEL, CROIX

L.F. Transformer

(3-1, 4-1, 5-1)

9/6 each, Super 11/6

Radio Panels

BLACK MATT FINISH

9 x 6 x 3/16 **1/6**

10 x 9 x 3/16 **2/2**

12 x 10 x 3/16 **2/9**

ALL SIZES STOCKED

POST FREE

RADIO PANEL Co.

143, Fetter Lane, E.C.4

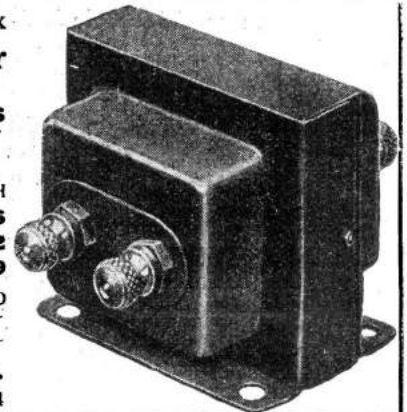

BRITISH BATTERY Co., LTD.

CLARENDON RD., WATFORD, Herts

(Telephone: Watford 617)

FOR

H.T. BATTERIES

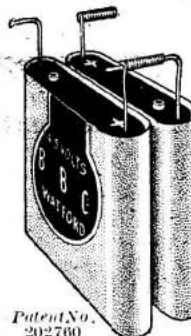

No. 1 W.

Standard Pocket Lamp Size—1 1/2 volt with patent spiral wire terminals and plug sockets to take Wander Plugs.

Note:—1 doz. = 54 volts. Used units replaced easily.

To connect in Series insert straight Terminal in spiral of next battery. Bend spiral and thus ensure permanent electrical connection without sold ring. (See Illustration.)

PRICE CARRIAGE PAID 7/- PER DOZ. WITH PLUG

All standard voltages supplied with 3 volt tappings.

Guaranteed British Made at our own Watford Works

Patent No. 202760

Barclays 895

Reactone Coils bring Stations in that you would never hear without them

With tension-winding we are able to dispense with all ebonite, empire tape, or other substances which introduce additional self-capacity, and at the same time secure a unique low-capacity formation that makes tuning sharper, signals stronger, and reaction readier.

Supplied in sets of 5 (Nos. 25, 35, 50, 75 and 100), and each set is boxed. Be sure to see the name "Reactone."

Reactone
TENSION-WOUND
Inductance Coils

No. 150 (Chelmsford) Price 1/9

No. 200 .. 2/3

Reactone Coil Holder 1/3

Ask your Wireless Dealer: In case of difficulty send P.O. (adding 3d. for postage) with your Dealer's name and address, to the Manufacturers:

LEWIS HARFORTH & CO., 88-90, Chancery Lane, London, W.C.2
Phone: Holborn 2213.

Wholesale from V. Zeitlin & Sons, 144, Theobald's Road, London, W.C.1



The World's Greatest Transformer

9/6 9/6

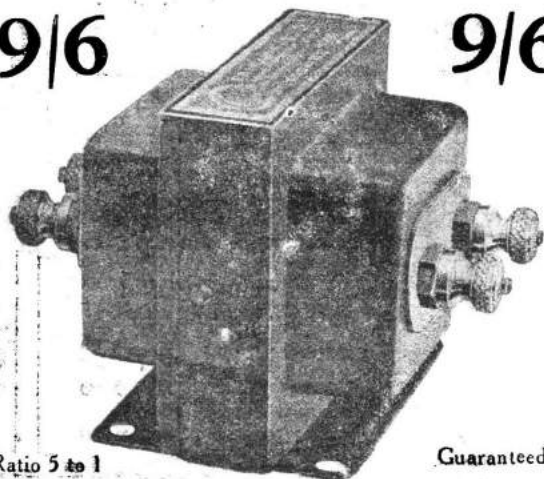

Ratio 5 to 1

Guaranteed

"Over 500,000 in Use."

The Croix Transformer has the largest sale of any transformer in the world. It is manufactured in FRANCE by a firm whose long experience and improved manufacturing methods are the best guarantee of its performance. It is in extensive use in the *United States, France, Germany, Spain and Italy.* Cheap transformers are dear at any price. The "Croix" is guaranteed to give a greater volume of amplification, without distortion than any other known transformer approaching its price.

Our Efficiency Guarantee

What does it mean to you?

It means that Croix Transformers are bought by YOU at OUR RISK, and that we guarantee that they will do all we say they will.

Obtainable from all wireless dealers, or direct from the SOLE DISTRIBUTORS for GREAT BRITAIN.

THE WHOLESALE WIRELESS CO.

"Quality House"

103, Farringdon Road, London, E.C.

Telephone: Clerkenwell 5312.

Sole Representative for the British Colonies, Dominions and Dependencies:

A. VANDAM

Caxton House, Westminster, London, S.W.1

Telephone: Victoria 3135. Telegrams: "Avandacom."

HOLDRON'S
PECKHAM, LONDON.

You obtain complete satisfaction by purchasing your Components from HOLDRONS. Only goods which are known to fulfill the Makers' claims and bear their guarantee are stocked. We refund money for anything returned as unsuitable. Post Orders are sent by return. Postage paid on Orders exceeding the value of £1.

RADIO MICRO DULL EMITTER VALVES

Consumption only .06 amps, 2½-3½ volts. These work exceedingly well in Mr. Percy Harris's short-wave Set. K.D.K.A. has been continuously received even on one valve.

Price 12/6
Postage 4d.

DUTCH DULL EMITTERS

Work on 2 volts, .06 amps. Excellent all-round valves.

Price 11/9
Postage 4d.

FRENCH R. VALVES

Bright Emitters. Excellent for Detectors or Amplifiers.

Price 6/11
Postage 4d.

DUTCH VALVES

Recommended as Detectors only. Filament voltage, 4, H.T. 30-80.

Price 4/6
Postage 4d.

DR. NESPER (GENUINE) HEADPHONES

Adjustable diaphragms, leather-covered headbands, comfortable in wear. Very sensitive, 4000 ohms.

Price 12/6. Postage 6d.

VARIABLE CONDENSERS

J.B. Square Law.
.0005 8/- .0003 6/9
.00025 6/9 Post free.

STERLING SQUARE LAW WITH VERNIER

.0005 25/6 .0003 23/6

NEW LOTUS GEARED COIL HOLDER

2 way 7/- 3way 10/6
Post free.

L.F. TRANSFORMERS

Ferranti, 17/6; R.I., 25/-; Pival, 9/6; Igranic, 21/-; Eureka, 30/-; Eureka No. 2, 22/6; G.R.C., 18/-; Brunet, 13/6; Burndept, 24/-; Success, 16/-; Formo, 18/-; U.S., 18/-; Formo Unshrouded, 12/6.

AUSTRIAN DULL EMITTER VALVES

Filament voltage, 3-4. .06 amperes. Excellent all-round valves.

Price 10/11
Postage 4d.

AUSTRIAN VALVES

Consumption .2 amps. Work on 2 volts only.

Price 7/6. Postage 4d.

PHILLIPS

Bright Emitters. State whether required for Detector or Amplifier.

Price 7/6
Postage 4d.

JUNOT DOUBLE FILAMENT VALVES

4-6 volts up to 120 plate voltage. State whether required for Detector or Amplifier.

Price 6/11
Postage 4d.

HOLDROPHONES

Aluminium headbands, laminated magnets, 4000 or 8000 ohms. Super sensitive.

Price 10/6
Postage 6d.

LOUD SPEAKERS IN STOCK £ s. d.

Sterling Dinkie	1	10	0
" Baby	2	15	0
" Audivox	5	5	0
" Primax	7	10	0
Amplion Dragonfly	1	5	0
" Junior	1	7	6
" Junior			
Dragon	3	10	0
" Swan-neck	6	0	0
" Sparta	5	15	0
Ultra	1	7	6
Celestion	6	0	0
C.A.V. Tom Tit	1	5	0
T.M.C. Junior	1	1	0
Claritone	5	15	0
" Junior	2	15	0
Nesper	0	19	11
All Post Free.			

NEUTRODYNE CONDENSERS

Colvern, 3/6.
Bowyer Lowe, /-.
McMichael H.F. Transformers.
Post Free 10/-. All ranges.

Radion & Paragon Panels. All Sizes. List Prices.

H. HOLDRON, Ltd. 117-147, RYE LANE, Peckham, London, S.E. 15

WARNING

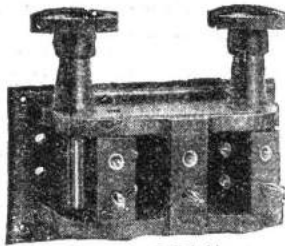

**Coil-Holders,
Two-way and
Three-way**

**Letters Patent
Number 193150**

Three-way Coil-holder

It has come to our knowledge that certain coil-holders are being offered for sale which are not of our manufacture and which are infringements of our Patent Number 193150.

It is our intention to uphold our rights and the rights of our licensees under this patent, and both trade and public are warned that the sale or use of these imitation coil-holders renders them liable to action. Terms will be quoted to potential licensees on request.

January 31st, 1925.



BURNDIPT Ltd., Aldine House, Bedford St., Strand, W.C.2

The "Tangent" Range



"TANGENT" LOUD SPEAKERS

Every "Tangent" tells its story with the marvellous tone and tune with which it reproduces the speech and music your valve or crystal has culled from the ether.

It tells the story by its every perfection; of 30 years experience; of care and consideration given to every part and proportion, all balanced in such happy combination as to produce perfect speech and accurate music.

Ask for the "Tangent" Loud Speaker and refuse all substitutes.

Concert Model	-	-	£5 0 0
"Tangent Tall Boy" (as shown—30" high)	-	-	£5 0 0
"Baby Tangent" (16½" high)	-	-	£2 2 0

GENT & CO. L^{TD.} Faraday Works, LEICESTER: Est. 1812

London:—25 Victoria St., S.W.1.
Newcastle-on-Tyne:—Tangent House, Blackett St.

Ask your local dealer for
"WESTMINSTER"
Wireless Components. If he cannot supply you, send direct to us and give us his name and address.



The **"WESTMINSTER"**
Adjustable coil winder. You can make coils of any width or weave on this machine and save yourself pounds.
Price 5/-

The cheapest and best vernier coil holder on the market.

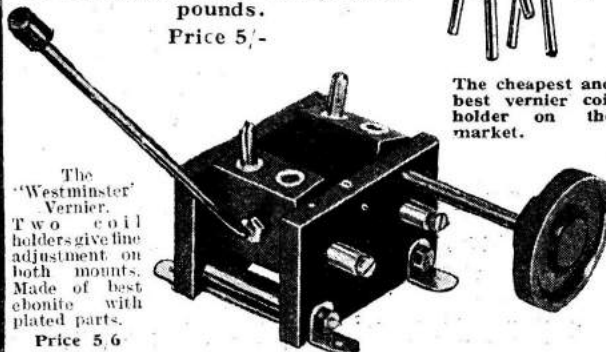

The **"Westminster" Vernier**. Two coil holders give fine adjustment on both mounts. Made of best chromite with plated parts.
Price 5/6

WATSON JONES & Co. (Wholesale only)
St. Stephen's House,
Victoria Embankment, London, S.W.1
Phone: Victoria 7571.

WIRELESS WEEKLY

was first in the field again with a stupendous new feature which commenced with the March 4th issue. Week by week it publishes advance details of the

PROGRAMMES OF CONTINENTAL AND AMERICAN BROADCASTING STATIONS

giving times, names of artists, the songs and music rendered and other information of interest.

Published every Wednesday, 6d.

RADIO PRESS LTD., Bush House, Strand, London, W.C.2

EVERYBODY BUYS FROM BLAND'S !!

THE NEW REGINA DULL EMITTER .06 VALVE
Tested against every well-known valve and it Beats the Lot
NEW ZEALAND ON ONE VALVE. PRICE 15/-

Radio Micro .06 Valve ..	11/6	2-Volt Accumulator, charged	3 9
Telefunken Lightweight Adjustable Phones ..	21/-	R.I. Permanent Detector ..	6 -
Telefunken Type Phones ..	9/6	Ondia Wavemeter, 25 to 25,000 metres ..	4 10 0
		Croix Shrouded Transformer	10 -

TRADE LISTS ON APPLICATION EQ:

S. E. BLAND, A.C.G.I., B.Sc.
82a & 97, QUEEN ST., LONDON, E.C.4



The Law of Supply and Demand

When the DEMAND EXCEEDS THE SUPPLY, the price of the article tends to increase; WHEN THE SUPPLY exceeds the DEMAND, the price tends to decrease. If full value is offered, the demand will always be greater than the supply, and there will be no need to reduce the price of the article, moreover, the quality will remain the same. SUCH is the case with the—

C & S DULL EMITTER
2V. O.2A.
WHICH RECEIVED
NEW ZEALAND
ON A SINGLE VALVE

PRICE 12/- EACH
Showcards now available.
CRAIK AND SMITH
ALLEN STREET : : LONDON, E.C.1
Phone: Clerkenwell 7346



You, also, can increase your salary

"After 17 years with a London engineering firm I was receiving only £4 10s. od. a week, but becoming an I.C.S. student in Civil Engineering, I quickly got an appointment at £1,000 a year, which steadily increased to £2,500!"

Many thousands of such messages from grateful students have been received by the International Correspondence Schools, the originators of

SPARE TIME STUDY BY POST

The I.C.S. Diploma is known, valued, respected in every country. It is an insurance against unemployment, and wins prosperity and happiness for its owners.

SIR HAROLD BOWDEN, MANAGING DIRECTOR OF THE RALEIGH CYCLE CO., LTD., NOTTINGHAM, says:—

"The Diploma of the I.C.S. in the hands of an ambitious man can carry him far, as it has carried thousands. To possess this qualification is proof of a sound, thorough, and specialised education in the subject representing that man's vocation."

The I.C.S. originated spare-time technical training by post 33 years ago, and is by far the largest institution of its kind in the world. It has teaching centres in eleven countries, and students in fifty.

Write to-day for full information as to how the I.C.S. can help you in your chosen vocation. There are 300 I.C.S. Courses of which the following are the most important groups:—

- | | | |
|---------------------|----------------------------|------------------|
| Advertising | Engineering (all branches) | Salesmanship |
| Architecture | French and Spanish | Showcard Writing |
| Building | General Education | Textiles |
| Commercial Art | Plumbing | Window Dressing |
| Commercial Training | Professional Exams. | Woodworking |
| Draughtsmanship | | |

International Correspondence Schools, Ltd.
172, International Buildings, Kingsway, London, W.C.2.

YOUR SET DEMANDS

Energo PRODUCTS

There is nothing magical about radio. Cause and effect govern results as in everything. Incorporation of Energo Guaranteed Components in your set will ensure the best results obtainable at all times. Ask your dealer for them.

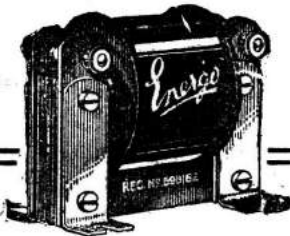

Energo L.F. TRANSFORMER

For Supreme Results, Efficiency, Finish and Permanent Reliability

The Energo L.F. Transformer is highly suitable for all circuits, and especially recommended for first stage and reflex circuits.

PRICE 15/- EACH

The Talk of the White City Exhibition

Purchase from your local dealer

If any difficulty in obtaining, please write direct to—

ENERGO PRODUCTS LTD.

2, OLIVERS YARD, E.C.1 and give us the name of local dealer.

Energo H.F. TRANSFORMERS MATCHED

Most attractive and efficient.		Wavelength		Price.	
Wound with silk-covered wire.		in Metres.			
Made in all wavelengths.		4	900—2000	4/6	
	Wavelength	5	1000—3000	4/9	
No.	in Metres.	6	2000—5000	5/-	
1	150—450	We recommend the use of these			
2	250—700	H.F.'s shunted with a .0002			
3	450—1200	V. Condenser across primary.			



Energo Low Capacity TUNING COILS

Sharp Tuning, Low Self-Capacity, Low Resistance, High Inductance.

These coils have been specially designed to give maximum results. Patent air-spaced winding and mounted in an anti-capacity and feather-weight method, they are particularly suitable where coil holders with loosely fitted spindles are used.

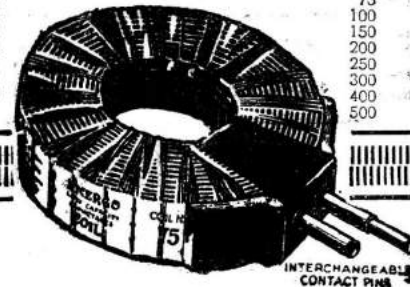

No.	Approximate Shunted with	Wavelength Condenser.	Price
25	Min. .0005	Max. .001	3/8
35	85	280	3/9
50	125	450	4/-
75	140	650	4/8
100	225	975	5/4
150	300	1300	6/-
200	500	2000	6/10
250	600	2500	7/1
300	750	2750	7/5
400	1000	4000	8/3
500	1300	5250	9/-
	1350	6500	

Barclays 816

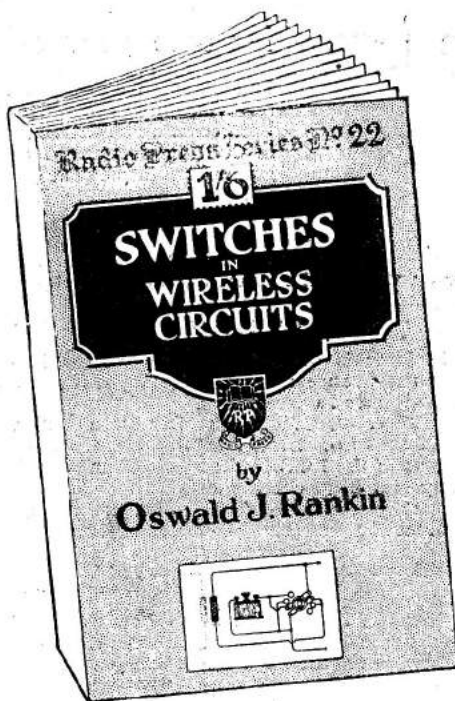

Switches in Wireless Circuits

By Oswald J. Rankin

THIS is the latest addition to the series of authoritative books on wireless published by the Radio Press, Ltd., books well known for their accuracy and great simplicity in giving the Public in a perfectly readable manner just the information they need.

This exceedingly useful Book contains over fifty different switching arrangements covering practically every possible requirement.

The diagrams are shown both theoretically and pictorially, so that even the absolute beginner cannot possibly go wrong through lack of knowledge in diagram reading.

Every enthusiast has used up valuable time worrying out the most efficient way to switch some particular circuit, component or accessory simply and economically. Switching often presents many difficulties, but with this new Book all difficulties arising from a desire to switch your set efficiently vanish, together with possibilities of destroying valves and injuring batteries.

Ask for the book with the distinctive yellow cover.

The Radio Press Series No. W22, Price 1/6.

*Obtainable from all Newsagents, Booksellers, your local Wireless Dealer,
or direct from the Publishers, Post Free 1/8.*

When ordering be sure and quote Series No. W22.



Switch and be Safe

Radio Press, Ltd.

BUSH HOUSE, STRAND, LONDON, W.C.2

Barclays 1231

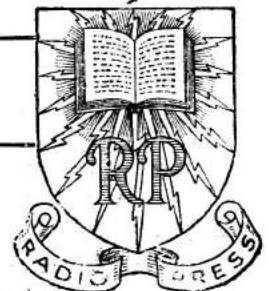

IF CHASEWAY ITS

IT'S THE RIGHT WAY
—ALWAYS
VARIABLE GRID LEAK

·001 to 20 megohms.

"CHASEWAY" has set a new and much higher standard in GRID LEAK manufacture and performance.

RELIABLE FOR ALL TIME

"Chaseway" will outlast everything else obtainable and give extraordinary sensitivity the whole time. Remote stations are brought into range and it really does all that a good grid leak should do.

No pellets, liquids or cardboard to get out of order. Made for one-hole fixing to replace the old-fashioned types.

Every one fully tested on a real "laboratory" instrument.

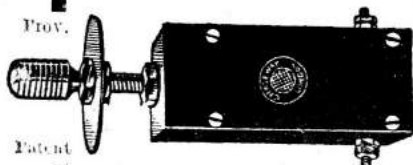

GRID LEAK ·001 to 20 meg. 4/-
Anode Resistance 19,000 to 500,000 ohms 4/-

HOME BATTERY CHARGERS

FOR DIRECT CURRENT

Thousands of the "CHASEWAY" STANDARD model DIRECT CURRENT chargers are giving satisfactory service in all quarters of the globe. Recharges your battery free, whilst current is in use in any part of the house for other purposes. Well finished and thoroughly practical.

No. 1 for 100 volt to 250 volt installations 25/- complete

No. 2 for 25 volt to 50 volt installations with 2 amp resistance lamp 35/- "

With 5 amp adjustable lamp 40/- "

No. 3 For Battery Charging depots, garages, etc. £4

FOR ALTERNATING CURRENT

1. Absolutely mechanical, no messy acids or liquids, no expensive bulbs to be replaced at frequent intervals.
2. Charges from zero up to 5 amps.
3. Suitable for all installations, 100 volt to 250 volt.
4. Will charge 2, 4, 6, 8, 10 x 12 volt accumulators for wireless or motor requirements.
5. A 6 volt 30 actual battery would only consume 1 unit.
6. Measures only 7" x 6" x 4" and is absolutely SAFE, RELIABLE and SILENT RUNNING.
7. Connects by lampsocket or wall plug.

Complete—£4-15-0 carriage extra. ASK YOUR DEALER

or remit direct if in any difficulty and send his name.

ILLUSTRATED CATALOGUE of these and other "CHASEWAY" NOVEL NECESSITIES on receipt of stamp.

CHASE ELECTRICAL Mfg. Co., Ltd.
184, Fleet St., London, E.C.4
Phone: Central 1539

F. Pethick—Advertising—London

And such a surface!

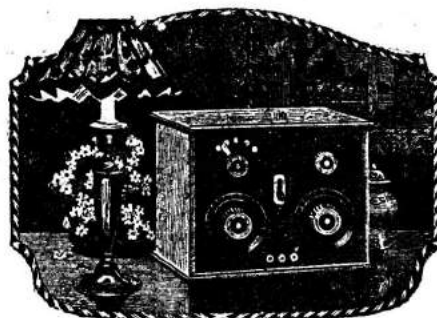

NOTHING improves the appearance of a Set more than a handsome polished panel, but because ordinary ebonite receives its bright surface by metallic methods, the wireless enthusiast is always advised to sandpaper it.

But Radion receives its polish in a different way and its beautiful lustre should not be removed before use.

The next time you go to your Dealer's ask him to show you a Radion panel and compare it with ordinary ebonite. Note the richness of its sheen—mere words cannot describe it—and you'll readily appreciate the wonderful difference it can make to the appearance of a Set.

But Radion excels in efficiency, too. It is infinitely superior to ordinary

ebonite. Developed in the factories of the largest manufacturers of ebonite in the world it has been evolved as the panel material *de luxe* for wireless.

Its insulation properties are exceptional and its dielectric constant has been reduced to 3.9. It cuts well, takes a good thread and never warps. Its handsome polished surface repels moisture and does not attract dirt. Radion is so tough that panels $\frac{3}{16}$ " thick are quite sufficient for all ordinary use. And finally this *de luxe* material is supplied in a large range of sizes in black and mahogany with dials and knobs to match. Each panel has its edges squarely cut and ground. If your own Dealer is out of stock of the panel you require he can get it by return, or, if you prefer it, you may order direct.

RADION

TRADE MARK

PANELS AND DIALS

Size	Black	Mahogany	Size	Black	Mahogany	Size	Black	Mahogany
6" x 7"	3 6	4 3	7" x 14"	8 -	10 3	8" x 26"	17 6	21 3
6" x 10 1/2"	5 3	6 6	7" x 18"	10 6	12 9	9" x 14"	10 6	12 9
6" x 14"	7 -	8 6	7" x 21"	12 3	15 -	10" x 12"	10 -	12 -
6" x 21"	10 6	12 9	7" x 24"	14 -	17 3	12" x 14"	13 3	16 -
7" x 9"	5 6	6 6	7" x 26"	15 -	18 6	12" x 21"	19 9	24 3
7" x 10"	5 9	7 3	7" x 30"	17 9	21 6	14" x 18"	19 9	24 3
7" x 12"	7 -	8 6	7" x 43"	28 -	34 6	20" x 24"	39 6	48 -

SPECIAL NOTE: All Radion Panels are $\frac{3}{16}$ " thick. In addition to the sizes listed above we can supply by return any special size cut to measure at the following prices:—Black, 1d. per sq. in.; Mahogany, 1 1/2d. per sq. in.

AMERICAN HARD RUBBER COMPANY (BRITAIN) LTD.
Head Office: 13a Fore Street, London, E.C.2.

Depots: 120 Wellington St., Glasgow. 116 Snow Hill, Birmingham.

Irish Agents: 8 Corporation St., Belfast
Gilbert Ad. 2513

In replying to advertisers, please mention THE WIRELESS CONSTRUCTOR.



REGISTERED
HAH
TRADE MARK
REGISTERED
TRADE
MARK

HUNT DETECTORS

with the *Micrometer Setting*

They overcome all difficulties. Besides ball and socket action, the pressure of the catwhisker has micrometer setting, and can be locked in position. The most delicate setting will never vary. A spare crystal cup and fixing bolts supplied with each detector, so that it may be used as double crystal or Perikon type without extra cost. Mention Fig. 922, Code word "VERNIER." Packed in carton with full instructions.

THE EXPERIMENTER'S GRID LEAK

Under panel and top panel types for delicate long distance tuning. The standard make has fixed resistances ranging from 1/2 meg. to 5 meg. stud and switch controlled. Each resistance is constant and definitely repeated at will.

Under panel, Fig. 1102, "Panleak," 5/- each. Top panel, "Varleak," Fig. 1100, 4/6 each. 5' anti-capacity handles, Fig. 1110, 9d. each extra. Special calibrations can be made to order for S.T. 100 and special Anode resistances.

A. H. HUNT, Ltd., (Dept. 15) HAH Works, Tunstall Rd., Croxson

4/-

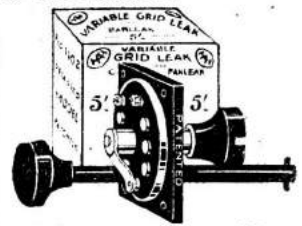

Talked about and approved by everybody

By *Amateur and Trade alike.*

"LOTUS" cut Geared Vernier Coil Holder

VERNIER of 8 to 1.
Moving Coil cannot drop.

Two-way. Price 7/-
Three-way. .. 10/6

Manufactured by
Garnett, Whiteley & Co., Ltd.
Lotus Works, Broadgreen Road, Liverpool

"Belling-Lee" Indicating Terminals
Patent No. 587,24

Heads cannot screw off
Tops engraved in White on Black 16 Indications

Grips a rpad tag or flex
Hole to grip a phone tag or solid wire

Standard 4 B.A. Stem
Serrated bottom prevents working loose

Brass, 3d. each
Nickel, 4d. each
Complete with nut and washer

"Belling-Lee" Plug and Socket Terminals

Recessed to take end of flex covering
Shock-proof in ulation handle in red and black

Internal all-metal 4-jaw chuck to grip any wire from 14 S.W.G. to 40 S.W.G.

Dome-shaped indicating discs in red and black 16 engravings
Transverse spring tongues pressing outwards ensure definite contact at many points

Complete with fixing nut
Price 7d. Per set

Soldering lug
M.K. Pat. No. 256,010 & 287,424

Your dealer can supply you. In case of difficulty, write direct to:
BELLING & LEE, Ltd., Queensway Works, Ponder's End

A GOOD HOME

What about the Cabinet for that Set you are building? It is worthy of a good home. Don't spoil it for the sake of a few shillings.

Why not try the people who specialise in Cabinets for any Radio Press Set or TO YOUR OWN DESIGN?

All Cabinets are guaranteed to be the best hand-made work in seasoned wood and hand polished; figured walnut is the standard.

Radiation or Ebonite drilled and engraved Panels supplied for any Set.

Example: Cabinet, Ebonite Panel, Powerful 3-valve Receiver by Percy W. Harris 19/- 11/-

Write NOW for Leaflets and Prices.

Tapped Coils for Simplicity and T.A.T. Circuits 8/-

"S. A. CUTTERS,"
15, RED LION SQUARE — LONDON, W.C.1
Phone: Chancery 8042. Cabinet Works, Pimlico.

MORE & MORE

HOME RADIO CONSTRUCTORS
ARE FLOCKING TO US—THE FIRM WHO REALLY GIVE PROMPT DELIVERY FROM VAST STOCKS OF PRACTICALLY EVERY WELL-KNOWN COMPONENT

Start building now—the best set you have ever made—with parts selected from our fine 50 page Illustrated Catalogue—post free for the asking

3/- Per Dozen
THE BRIGHTON RADIO STORES
163 Western Rd., Brighton

LISPEN 5 POINT SWITCH
4/-

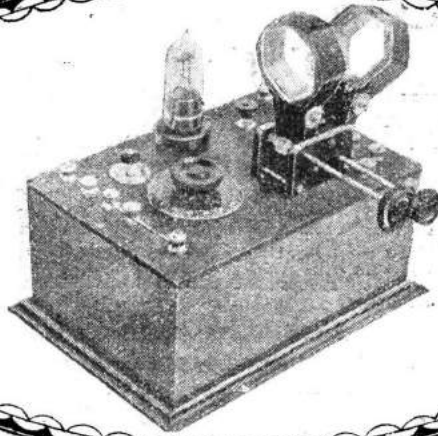

Build one of these Fine Simpson Single Valve Sets

RADIO PRESS envelopes contain all the information necessary to enable anyone to construct highly efficient wireless apparatus even if they have no previous technical or practical experience. Each envelope contains all necessary working drawings, instruction sheets, full sized blue prints and photographs.

Radio Press
Envelope No. 9
— — —
SIMPSON
Single Valve
Set
1s. 6d.
(Post free 1s. 9d.)

Envelope No. 9 enables you to make the splendid single valve set illustrated above. It has been designed by Herbert K. Simpson, and dozens of letters have testified to its range and power.

Envelope No. 8 enables you to make a one valve Reflex Receiver as illustrated below. Works from a Broadcasting Station, strong phone signals up to 50 miles.

Radio Press
Envelope No. 8
— — —
SIMPSON
One Valve
Reflex Receiver
1s. 6d.
(Post free 1s. 9d.)

Obtainable from booksellers and wireless dealers or direct from: Dept. W

Radio Press, Ltd.

The largest wireless publishers in the world,

Bush House, Strand, London, W.C.2.

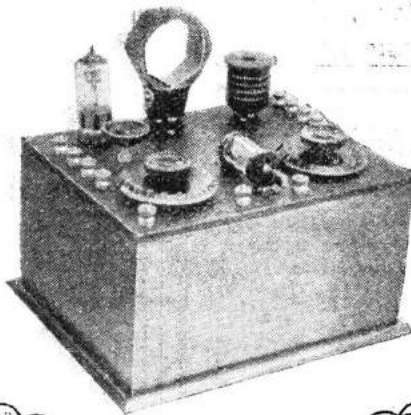

THE L.E.S. SHORTING PLUG

Designed to avoid the possibility of touching a bare wire or shorting bar. As illustrated.

9d. each



THE L.E.S. FLUSH MOUNTING COIL PLUG

A device to enable the experimenter to fit his loading coil or shorting plug flush with the surface of the panel. As illustrated.

9d. each



THE L.E.S. BASKET COIL HOLDER

A neat, rigid, support for every Basket Coil, made to fit every standard Coil Holder

1/2 each

With solid ebonite base, 1/6 each

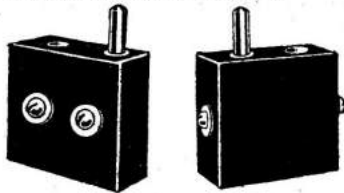

THE L.E.S. COIL PLUGS

are made of Pure Ebonite and are designed to meet the everyday needs of the wireless experimenter.

With Screw connections on face

(C3) 8 1/2d. each

With Screw connections on side

(C4) 8 1/2d. each

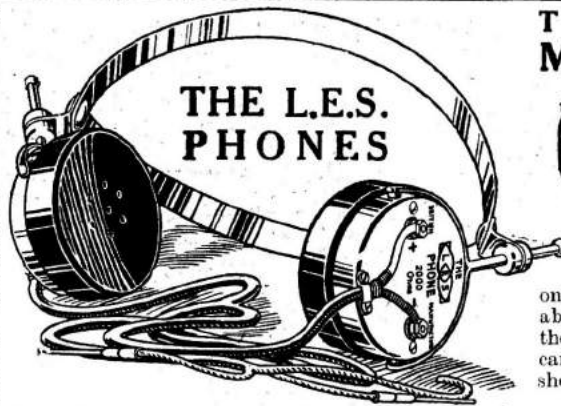

THE L.E.S. PHONES

These Phones are of the very best material and workmanship. The ear-pieces are wound to a resistance of 4,000 ohms, and are fitted with Stalloy diaphragms. The bands are of highly polished Duralumin, and the stirrups slide through a patent spring friction grip.

Every pair is tested for sensitivity and is sold under our guarantee.

PER 19/6 PAIR

This offer cannot be repeated. Next supplies of these phones will be at 22/6 per pair, so buy now.

Ask your local dealer for L.E.S. components. If he cannot supply, order direct, sending us his name and address, please.

LONDON ELECTRIC STORES, Ltd.

OXENDON STREET, HAYMARKET, S.W.1

Phone: REGENT 2505 and 2506

THE ORIGINAL L.E.S. MICRO-CONTROL

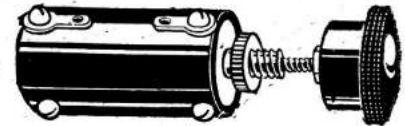

This resistance has a range of approximately 0 to 50 ohms, and gives micro-metrical control over filament potential on every type of valve. We claim it to be absolutely the best control of its type on the market to-day. Issued only in special cartons, complete with directions sheet Price 3/6

THE L.E.S. MICRO-VERNIER (2-way) COIL HOLDER

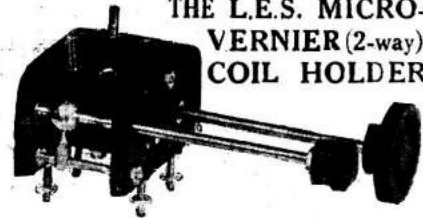

The secret of the success of this Coil Holder lies in the wonderful perfection of the Vernier movement—one complete turn of the small knob only moving the coil through 1.15 degrees. Price 7/6

With L.E.S. Patent Sub-Panel Connections. As illustrated Price 9/6

Specially Recommended by the Wireless Press

Barclays 815

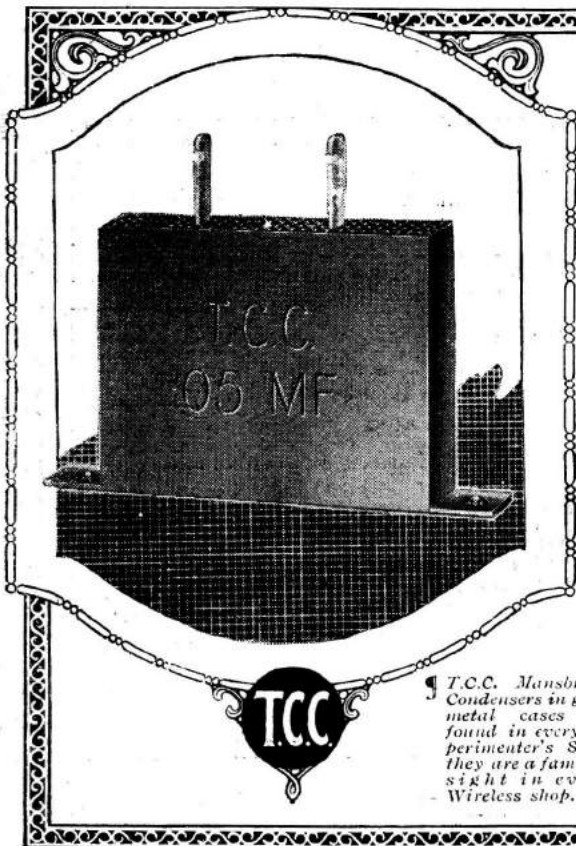

The Years Behind

WITH the advent of Broadcasting hosts of manufacturers—the majority of whom were entirely without experience—were quick to seize their opportunity and large quantities of totally unsuitable condensers were hurried along to meet the clamorous demand.

Whether the capacities were as marked—whether the insulation was perfect—whether the sealing was impervious to atmospheric conditions—these matters were seemingly of no importance.

But times have changed. The public has learnt a bitter lesson. It has realised that condenser building is a specialist's job—that mere text-book knowledge cannot compete with the hard school of experience.

The Telegraph Condenser Co., Ltd., for many years have been making condensers of every type—the name T.C.C., in fact, is everywhere accepted as the standard of accuracy and efficiency.

Look for the name
T. C. C.

T.C.C. Mansbridge Condensers in green metal cases are found in every experimenter's Set—they are a familiar sight in every Wireless shop.

Advertisement of The Telegraph Condenser Co., Ltd., Mortlake Rd., Kew.

Globe Ad. 2314



YOU NEED THESE BOOKS

Practical Wireless Valve Circuits
(Series No. 10.)

This is the first book of ST circuits and is called **Practical Wireless Valve Circuits**, by John Scott-Taggart, F.Inst. P., A.M.I.E.E. Price 2/6 (post free 2/8). Circuits ST 1 to ST 67 are published in this book, which is selling as well to-day as when it was published. No experimenter worthy of the name can afford to be without the two ST Circuit Books. They are friends which will never lead you astray. Each circuit in both books is fully described and criticised.

All Component values are given in the new editions of **Practical Wireless Valve Circuits** and **More Practical Valve Circuits**.

MORE PRACTICAL VALVE CIRCUITS



JOHN SCOTT-TAGGART, F.Inst.P.

"S.T." Circuits

These are too well known to need any introduction. This is the latest book of them:—

More Practical Valve Circuits
(Series No. 15.)

By JOHN SCOTT-TAGGART, F.Inst.P., A.M.I.E.E.
Price 3/6 (post free 3/8).

Full of dozens of original circuits which you will find nowhere else, as they are copyright. Circuits ST 68 to 140, also ST 150 and 151, appear in this extremely useful volume, which has had an enormous sale amongst experimenters.

Radio Valves and How to Use Them
(Series No. 12.)

Mr. Scott-Taggart has stated that he regards this as his best book on the Valve from the point of view of the beginner. **Radio Valves and How to Use Them**, by John Scott-Taggart, F.Inst.P., A.M.I.E.E. Price 2/6 (post free 2/8). This book is by far the largest published by Radio Press, Ltd., at 2/6, and is full of very valuable information. The reader is presumed to know only what is contained in our Books, "Wireless For All" and "Simplified Wireless."

THESE BOOKS YOU NEED

Wireless Valves Simply Explained
(Series No. 9.)

By JOHN SCOTT-TAGGART, F.Inst.P., A.M.I.E.E.

The most popular moderately priced Book on the theory of Valves yet written. It contains the results of many years' patient research and experiments—but told in a non-technical language which the amateur can easily understand.

How reaction is caused—how to stop self-oscillation—how to select suitable circuits for various purposes—how to receive C.W.—the answers to all these and many other questions are clearly given.

If you want to know how your set-works this is the Book you need.

2/6 or 2/8 post free.

All Radio Press Books are obtainable from principal wireless dealers and through any bookseller, newsagent or direct from Dept. "W," Radio Press, Ltd.



Radio Press, Ltd. BUSH HOUSE, STRAND, LONDON, W.C.2



THE BOOKS for Beginners and Experts

WITHOUT a doubt the very remarkable growth in the number of home-built Receiving Sets can be attributed to the exceptional Books and Magazines published by Radio Press, Ltd. This organisation—the largest of its kind in the world—has risen from quite modest beginnings because it was the first to realise that the crying need then, as now, was for dependable literature.

The moment a man gets really interested in Radio he is so fascinated that he immediately wants to learn more about it. Naturally he buys books and magazines—but let those books or magazines be too technical that he cannot understand and appreciate them, or let them contain inaccuracies or mis-statements, and Radio loses another promising recruit.

Radio Press, Ltd., pursues a definite policy in its book publishing which can be summed up as follows:—

(a) It publishes Books written only by authors of repute. Its Editorial Staff—both in number and in experience the strongest in the country—is well able to check every manuscript submitted and to supervise generally the publication of every Book.

(b) Each Book selected for publication must fill a definite niche in the Radio Press Series. Just as there are many grades of wireless enthusiasts from novices to experienced experimenters, so there must be various types of Radio Press Books. At the same time, however, every phase of the Science is covered so thoroughly that anyone can build up a complete library as his knowledge increases.

(c) Every Radio Press Book is printed in good style, profusely illustrated and represents particularly good value for money. While several of the more elementary ones are published at a cheaper price, the bulk of the Radio Press Series cost 2/6 each. This price permits a very high quality being maintained, and allows half-tone illustrations and, in the case of the constructional books, the fullest descriptions being given of every stage of Set building.

Make up your mind to look through the whole series at your Bookseller's or Wireless Dealer's—he has them in stock or will get them for you. It will be your first step to increased proficiency.

All Radio Press publications can be obtained from any Newsagent, Bookseller, local wireless dealers, or direct from the Publishers.

Complete List (W) Free on Application
Radio Press Ltd.,
Bush House, Strand, London, W.C.2

Barclays 1231

Get a CLIMAX Earth

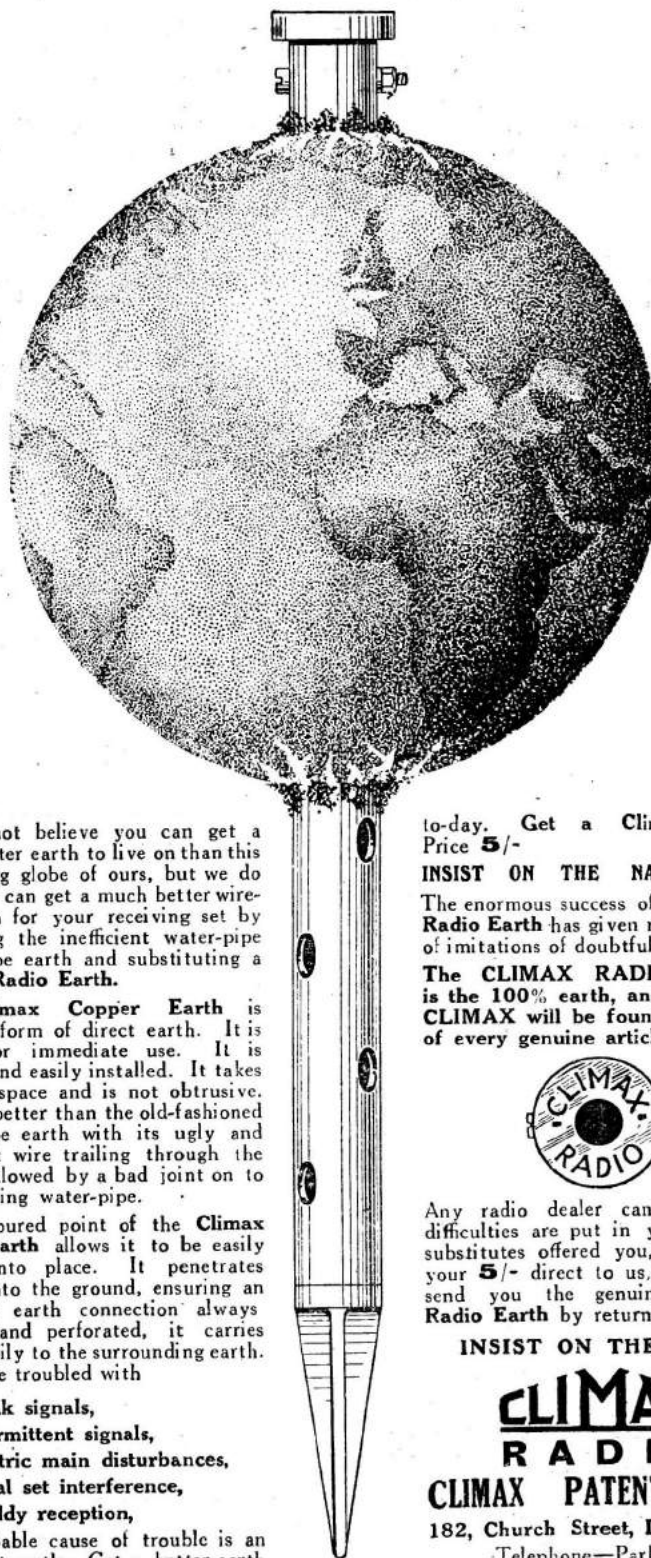

We do not believe you can get a much better earth to live on than this old rolling globe of ours, but we do know you can get a much better wireless earth for your receiving set by abolishing the inefficient water-pipe or gas-pipe earth and substituting a Climax Radio Earth.

The Climax Copper Earth is the best form of direct earth. It is ready for immediate use. It is quickly and easily installed. It takes up little space and is not obtrusive. It is far better than the old-fashioned water-pipe earth with its ugly and inefficient wire trailing through the house, followed by a bad joint on to a wandering water-pipe.

The armoured point of the Climax Radio Earth allows it to be easily driven into place. It penetrates deeply into the ground, ensuring an excellent earth connection always. Drilled and perforated, it carries water easily to the surrounding earth. If you are troubled with

Weak signals,
Intermittent signals,
Electric main disturbances,
Local set interference,
Muddy reception,

the probable cause of trouble is an inefficient earth. Get a better earth

to-day. Get a Climax Earth.
Price 5/-

INSIST ON THE NAME—CLIMAX

The enormous success of the Climax Radio Earth has given rise to a flood of imitations of doubtful efficiency.

The **CLIMAX RADIO EARTH** is the 100% earth, and the name **CLIMAX** will be found on the cap of every genuine article.



Any radio dealer can supply. If difficulties are put in your way, or substitutes offered you, please send your 5/- direct to us, and we will send you the genuine **CLIMAX Radio Earth** by return.

INSIST ON THE NAME

CLIMAX
RADIO
CLIMAX PATENTS, LTD.

182, Church Street, London, W.8
Telephone—Park 2023

Why I read "Wireless Weekly"

1. BECAUSE, chiefly, I feel safe. I know that behind this paper is the RADIO PRESS, the largest Wireless Publishing concern in the World, and this *their* weekly.
2. BECAUSE the Editor is John Scott-Taggart, F.Inst.P., A.M.I.E.E., and the Assistant Editor is Percy W. Harris, and because this is the only weekly wireless paper which contains articles by such other well-known writers as Cowper, Hallows, Kendall, Rattee, Redpath, etc., etc.
3. BECAUSE it is beautifully printed on the finest quality paper, and all the photographs come out clearly and not as smudges, as is so often the case.
4. BECAUSE of the regular "Valve Notes" which appear weekly and are written by the Editor. Nothing like these appears anywhere else. WIRELESS WEEKLY appeals to me because I am a valve user, and the paper caters very largely for the valve man.
5. BECAUSE I thoroughly enjoy "Jottings By the Way," a very witty weekly feature (now illustrated), by the way.
6. BECAUSE new circuits and designs appear regularly and many of them never appear elsewhere. I know that if I miss my WIRELESS WEEKLY I shall miss something new.
7. BECAUSE I am pleased to reply "WIRELESS WEEKLY" when my friends ask me what I read. I know that they know that WIRELESS WEEKLY is a paper in a class by itself. Its price is the highest of the weeklies, and though not a snob, I don't mind my friends knowing that I want the best—and get it.
8. BECAUSE it's a "live" paper. It does things. It's the most virile of the RADIO PRESS periodicals. It criticises fearlessly on wireless topics of the day. Its test reports on wireless apparatus are equally fearless. If something new comes along, whether it is oscillating crystals, a new circuit, a new move by the Post Office, every keen wireless man wants to know "what WIRELESS WEEKLY has to say about it"—and they are never disappointed.

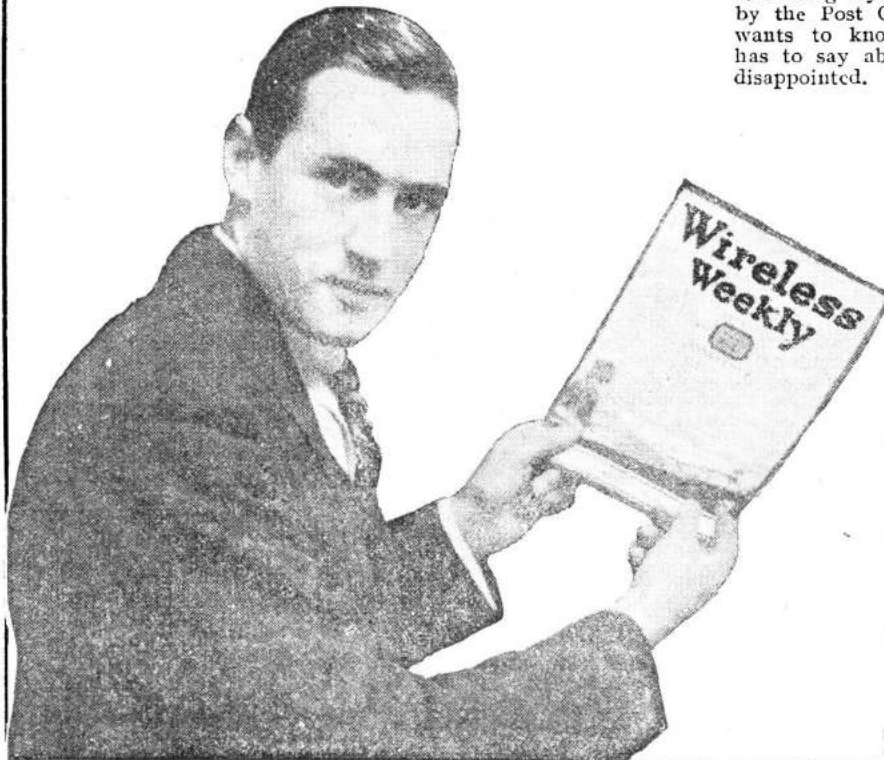

MY PAPER!

Published every Wednesday by
Radio Press, Ltd., Bush House,
Strand, London, W.C.2.
6d. WEEKLY.

Cut Here

To Newsagent,

Please { deliver } me a copy of
 { reserve } "WIRELESS WEEKLY"
every week.

Name

Address

**LAST
FEW
COPIES**

PITMAN'S RADIO YEAR BOOK. 1/6

Sixty-five thousand copies of this handy reference book for all "listeners in" have now been sold with the exception of a few copies. It will not be reprinted, so readers who have not already obtained their copies for 1925 are advised to do so at once. The collection of over 100 illustrations and photographs of artists is alone worth many times the price of the book. Therefore order your copy now.

At Bookstalls
or Pitman's,
Park St.,
Kingsway,
W.C.

BARCLAYS SERVICE

The experience of the Principal and staff of this Agency is such that their advice and assistance, freely given to wireless manufacturers and retailers, is accepted as sound, accurate in every detail and of proven value.

The Manager has been intimately associated with wireless and advertising from the days when there was only one public wireless periodical in this country. He is well known to the trade generally and has chosen a staff of experienced men, each of whom, in his own sphere, is able to solidify the complete service rendered by the agency.

Representatives, copy writers, artists and lay-out men are all in close touch with every aspect of wireless sales promotion.

Why not take advantage of this accumulated experience and knowledge of present-day methods so essential to the expansion of your business.

Consultations Free by appointment.

BARCLAYS ADVERTISING Ltd

Advertising Consultants & Contractors

Bush House, Strand, London, W.C.2

Telephone: City 9911 (Extn. 9).

COUPON

Questions & Answers

This coupon must be accompanied with a 2/6 P.O.

"WIRELESS CONSTRUCTOR"
April, 1925.

EASY PAYMENTS

LOUD SPEAKERS. Any make. Your selection. Amplion, Brown, Sparta, Sterling, etc. Quarter deposit. Balance six monthly payments. Examples: **DINKI**—11/- deposit; 2 monthly payments 11/-; **AMPLION JUNIOR-DE-LUXE**—14/6 deposit; 6 monthly payments 9/-; **BROWN HI**—27/- deposit; 6 monthly payments 14/2

Other M. dets. Headphones, Parts, etc. similar to ours.
ACCUMULATORS Best quality. Guaranteed. Three in thly

Cash payments		Cash payments	
Three in thly		Three in thly	
4 v.-40	17/ 6/3	6 v.-40	25/ 9/
4 v.-60	22/6 8/3	6 v.-60	32/ 11/6
4 v.-80	27/- 9/9	6 v.-80	38/6 14/
4 v.-100	32/- 11/6	6 v.-100	45/- 16/-

Care and Packing, 1/6 any size
H. W. HOLMES, 29, Foley Street, Great Portland Street, W.1. Phone: Museum 1-14

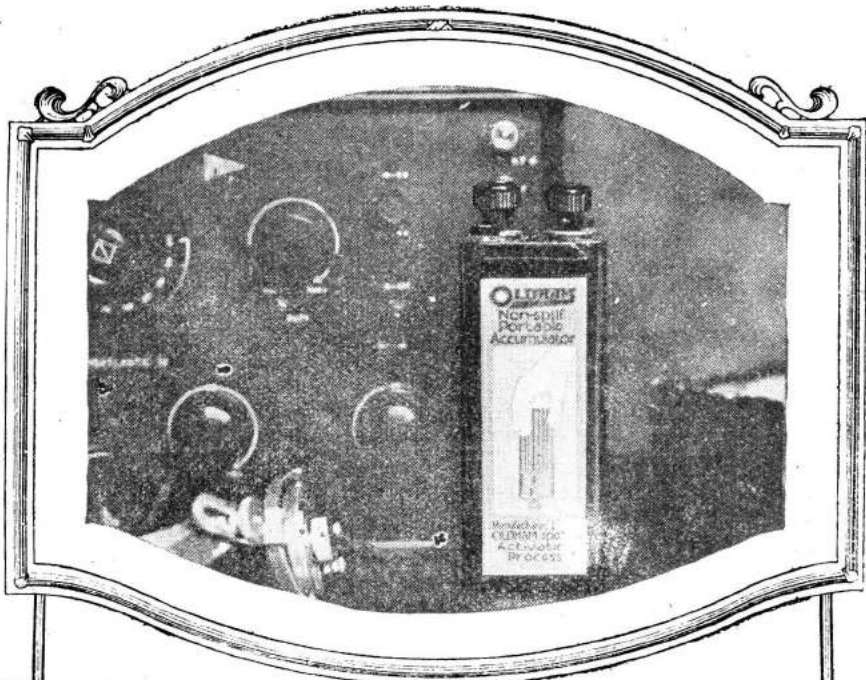

Developed for the coal-mine—perfected for Radio

SEVERAL years ago the Oldham special activation process passed its final tests and large quantities of the new Oldham Accumulators were supplied to coal mines throughout the country for use in the Oldham Miners' Electric Lamp. They were a tremendous success—as we knew they would be. Extreme reliability—low upkeep costs—steadiness of output—the ability to hold a charge over extensive periods when not required for use—these and many other features have caused the sales of Oldham Accumulators to rise to a phenomenal height during the last year or two.

And now the same qualities that are in such demand below ground have combined to make the Oldham the Accumulator-de-luxe for Radio use. It may cost you a shilling or so more than an ordinary accumulator—but remember that you can never really tell the cost of an accumulator until it is worn out. On that basis alone Oldham Accumulators are cheapest of all—for none can approach them for long life.

All good Radio Dealers stock them in the usual voltages and capacities.

OLDHAM & SON, Ltd., Denton, Manchester
London: Great Chapel Street, Oxford Street, W.1
Newcastle: 1, St. Mary's Place



Gilbert Ad. 2304

In replying to advertisers, please mention THE WIRELESS CONSTRUCTOR.



**The Media in
Wireless Journalism**

which constitute a complete and efficient Advertising Campaign for Selling Sets Components or Accessories.

440,000!

DON'T EXPERIMENT with so-called infallible media for SELLING your Wireless Sets, Components or Accessories. Experimenting with Wireless Sets may be—and no doubt is—a lucrative and instructive hobby, but experimenting with your business and its capital is another thing altogether. It is invariably Suicidal. Start right at the commencement of your campaign by using only "MODERN WIRELESS," "WIRELESS WEEKLY" and the "WIRELESS CONSTRUCTOR," the predominant three in wireless, and, incidentally, the only journals that matter in creating a public demand for your manufactures. When you have booked space in them your appropriation is complete and beyond equal.

In substantiation of this statement your advertisement will be read by no fewer than 440,000 wireless enthusiasts—those that are really keen and are continually buying for new experiments and home-constructed sets. This figure represents the certified circulation of these papers, one of which alone has a circulation greater than that of all Non-Radio Press wireless papers added together. The elite and professional men, besides the amateur and experimenter, are readers and all may, therefore, be safely classed as potential customers. In fact there is no waste circulation whatever.

Do not tolerate disappointing results any longer—they can be remedied, and speedily too.

Phone: City 9911 (Extn. 9), or write for advertisement rates of "MODERN WIRELESS," "WIRELESS WEEKLY" AND "WIRELESS CONSTRUCTOR" to the Advertisement Manager,

BARCLAYS ADVERTISING, Ltd.

Advertising Agents, Consultants & Contractors,
BUSH HOUSE, STRAND, LONDON, W.C.2.

Telephone. City 9911 (Extn. 9).

THE BOOKS

for Beginners
and Experts

The Radio Press Series

No.		Price
1	Wireless for All .. By John Scott-Taggart, F.Inst.P., A.M.I.E.E.	9d.
2	Simplified Wireless .. By John Scott-Taggart, F.Inst.P., A.M.I.E.E.	1/-
3	How to Make Your Own Broadcast Receiver .. By John Scott-Taggart, F.Inst.P., A.M.I.E.E.	1/6
4	How to Erect Your Wireless Aerial .. By B. Mittell, A.M.I.E.E.	1/-
5	The Construction of Wireless Receiving Apparatus .. By P. D. Tyers.	1/6
6	The Construction of Crystal Receivers .. By Alan L. M. Douglas.	1/6
7	How to Make a "Unit" Wireless Re- ceiver .. By E. Redpath.	2/6
8	Pictorial Wireless Circuits .. By Oswald J. Rankin.	1/6
9	Wireless Valves Simply Explained .. By John Scott-Taggart, F.Inst.P., A.M.I.E.E.	2/6
10	Practical Wireless Valve Circuits .. By John Scott-Taggart, F.Inst.P., A.M.I.E.E.	2/6
12	Radio Valves and How to Use Them .. By John Scott-Taggart, F.Inst.P., A.M.I.E.E.	2/6
13	500 Wireless Questions Answered .. By G.P. Kendall and E. Redpath.	2/6
14	12 Tested Wireless Sets .. By Percy W. Harris.	2/6
15	More Practical Valve Circuits .. By John Scott-Taggart, F.Inst.P., A.M.I.E.E.	3/6
16	Home-Built Wireless Components ..	2/6
17	Wireless Sets for Home Constructors .. By E. Redpath.	2/6
18	Tuning Coils and How to Wind Them .. By G. P. Kendall, B.Sc.	1/6
* 21	Six Simple Sets .. By Stanley G. Rattee, Member I.R.E.	1/6
* 22	Switches in Wireless Circuits .. By Oswald J. Rankin.	1/6
RADIO PRESS PANEL CARDS		
1	How to Make the W.I. Receiver .. By Herbert K. Simpson.	1/-
SIMPLEX WIRING CHARTS		
1	For 2-Valve Set ..	1/-
2	For 3-Valve Set ..	1/-
3	For 4-Valve Set ..	1/-
RADIO PRESS WIRELESS "PANEL TRANSFERS" .. COIL		
"MODERN WIRELESS" .. COIL TABLE for Aerial, Anode and Re-action Coils ..		
RADIO PRESS ENVELOPES		
1	How to Build an S.T.100 Receiver .. By John Scott-Taggart, F.Inst.P., A.M.I.E.E.	1/6
2	How to Build a 4-Valve Receiver .. By Percy W. Harris.	2/6
3	How to Build the "Simplicity" 3-Valve Set. By G. P. Kendall, B.Sc.	2/6
4	How to Build the All-Concert-de-Luxe Receiver. By Percy W. Harris.	2/6
* 5	How to Build the Omni Receiver .. By John Scott-Taggart, F.Inst.P., A.M.I.E.E.	2/6
* 6	How to build the A.B.C. Wave Trap .. By G. P. Kendall, B.Sc.	1/6
* 7	How to Build a 2-Valve Amplifier de-Luxe .. By Herbert K. Simpson.	1/6
8	How to Make a 1-Valve Reflex Receiver .. By Herbert K. Simpson.	1/6
9	How to Build an Efficient Single Valve Set. By Herbert K. Simpson.	1/6

* Just Published.

All above can be obtained from wireless
dealers, booksellers—or direct (plus 2d. postage
on books and 3d. on Envelopes) from Dept. W.,

RADIO PRESS, LTD.

BUSH HOUSE, STRAND, LONDON, W.C.2

Barclays Ad



Dimple Cheeks!

THE kind of Headphones that children want are those that are light in weight, that fit closely to the ears, that have long cords to allow free movement, and, finally, that are really sensitive to the merest whisper.

But aren't these the chief qualifications of Headphones for grown-ups, too? If you have always felt that Headphones must necessarily be uncomfortable, heavy and clumsy, you have, probably, never tried **Brown** Featherweights. Weighing only six ounces (including cords) they are a masterpiece of ingenuity. For sensitiveness and purity of tone they are unsurpassed—and now they have been reduced in price to 20/- per pair they are even better value. Buy a pair from your dealer to-day and compare them with those you are at present using.

Reduced Price: F type Headphones 20/-
120 ohms and 4000 ohms

S. G. BROWN, LIMITED, Victoria Road, N. ACTON, W.3

Showrooms—

91 Mortimer St., W.1 15 Moorfields, Liverpool 67 High St., Southampton

Brown

HEADPHONES AND LOUD SPEAKERS.

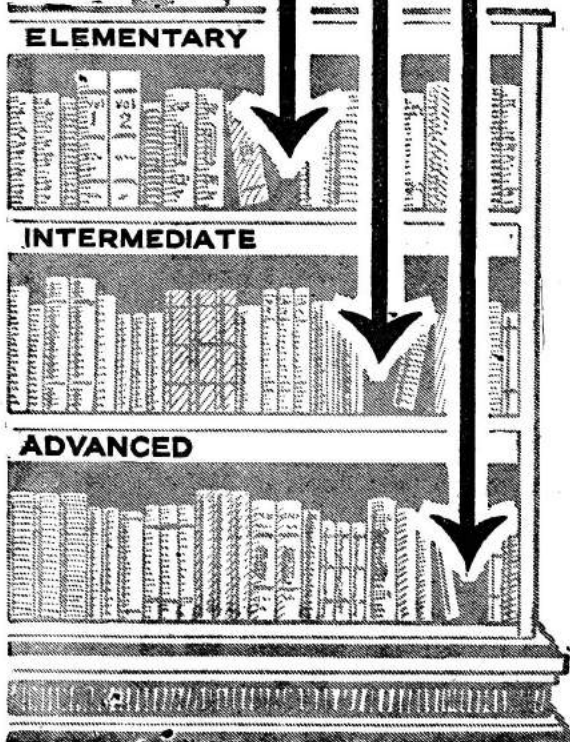

Put it there!

NO matter whether you are a beginner, amateur or expert in matters wireless, you will find one or more books that will be of very great assistance to you among the excellent series published by the Radio Press. It is quite likely that one of those illustrated above is just what you need now.

HOW TO MAKE YOUR OWN BROADCAST RECEIVER.

By John Scott-Taggart, F.I.S.T.P., A.M.I.E.E.

An ideal book for the beginner, showing how he can build cheaply and well a Broadcast Receiver.

Series No. W3

1/6 or 1/8 post free.

HOME BUILT WIRELESS COMPONENTS.

Shows how the enthusiast can make for himself every component required for a Receiving Set. It pays for itself in the first few pages.

Series No. W16

2/6 or 2/8 post free.

WIRELESS SETS FOR HOME CONSTRUCTORS.

By E. Redpath.

A book which instructs its readers how to make efficient Wireless Sets for all purposes.

Series No. W17

2/6 or 2/8 post free.

Complete List "W" of Radio Press Series of Books will be sent post free on application. Obtainable from all Newsagents, Bookstalls, local Wireless Dealers, or direct from the Publishers. When ordering direct be sure and quote Series No. "W-".

Radio Press, Ltd.
BUSH HOUSE, STRAND, LONDON, W.C.2.



Barclays 1226

RADIOCO LIMITED

The All-Round Radio SERVICE BUREAU

RADIOCO Limited has been established to meet the Radio user's demand for one central depot to which he can turn for all his varied needs and services—and which he can look to always as a source of help and information in any Radio problem or difficulty that he may encounter. A comprehensive range of guaranteed Radio instruments and accessories of all kinds is always in stock—every British make being carried—and any article purchased through Radioco Limited can be safely looked upon as genuine and reliable. Write for illustrated catalogues and booklets.

Borrow a Book!

Many a time you may feel the need of a good Book to explain and illustrate some phase of Radio in which you are particularly interested at the moment. At the same time, the price of the book may be more than you feel justified in paying for the information you need. The RADIOCO LIBRARY SERVICE exists to meet just such cases as this. It loans you the book you need at a fraction of the price you would pay for it. Send a postcard for full details and list of books already available. Address: Library Bureau, Radioco Limited, 90-91, High Holborn, London, W.C.1.

Testing and Calibrating Laboratory Service

Here is another invaluable service for the Radio user. Realising the urgent need for a means of Repairing, Testing and Calibrating Radio Receivers and Components, we have equipped a section of our premises with a most complete and efficient laboratory for this purpose. To appreciate fully all that this service means to you and to the results you get, write for fuller particulars to T. & C. Laboratories, Radioco Limited, 90-91, High Holborn, London, W.C.1.

Installation and Maintenance Service

Radioco undertakes the installation of Sets, Erecting of Aerials and maintenance of same. This work is carried out by thoroughly experienced Radio fitters, after submitting our suggestions to you for your approval. When you select your Receiver we undertake the rest, see that the installation is erected and left working satisfactorily, and keep in touch with you, to attend to any difficulties that may arise. Write to I. & M. Service, Radioco Limited, 90-91, High Holborn, London, W.C.1.

Radioco Will Help and Advise You—FREE!

A further service that all Radio Users will appreciate is our Advice and Information Bureau. An expert Technical Adviser conducts this department and his services and knowledge are at your disposal—FREE! State your problem clearly, fully and yet as briefly as possible. Address: Advice Bureau, Radioco Limited, 90-91, High Holborn, London, W.C.1.

RADIOCO Limited
The Radio Users' Service Bureau
90-91, HIGH HOLBORN, LONDON, W.C.1
Telephone - - Holborn 1744

ROSEBROS

GUARANTEED
RADIO
COMPONENTS

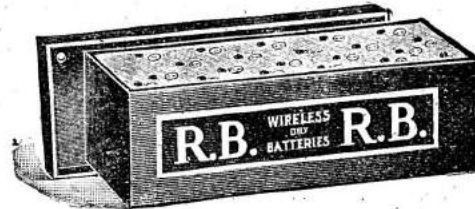

15 Volt $2\frac{2}{3}$ each 60 Volt $9\frac{1}{3}$ each
36 Volt $5\frac{2}{3}$ each 100 Volt $14\frac{2}{3}$ each

These batteries are specially made for Radio work and are noiseless in use. Guaranteed to give satisfaction in service. The result of over 15 years' experience in Battery Manufacture.

R.B. High Frequency Transformers

No. 0	150- 300 Metres	7/- each
No. 1	275- 450 "	7/- each
No. 2	400- 700 "	7/- each
No. 3	650-1150 "	7/- each
No. 4	1000-2500 "	7/- each
No. 5	2000-4000 "	7/- each



Low self-capacity and high efficiency transformers. Ebonite formers and green silk-covered windings. Specially designed for neutrodyne circuits. Matched pairs can be supplied at NO extra cost for tuning with double condenser.

A NATURAL CRYSTAL

Super Sensitive and Guaranteed.

6d.

Sealed Boxes.



6d.

Sealed Boxes.

Each crystal is tested and will give results equal to many high-priced and fancy-named crystals. A really good rectifying mineral at a reasonable price.

For use on ANY type of circuit.

The above TESTED Wireless Components can be obtained from all First-class Wireless Dealers and Stores, or Post Free from any of our addresses below.

Trade enquiries invited

ROSE BROS.
ELECTRICAL CO., LTD.

LONDON: 25, Milton Street, E.C.2
GLASGOW: 194a, St. Vincent St.
MANCHESTER: 25-27, Miller St.
BRISTOL: 83a, Redcliffe Street

S.S.A.

Index to Advertisers

	PAGE		PAGE
Agar (W. H.)	579	Garnett, Whiteley and Co.	589
American Hard Rubber Co.	587	General Radio Co.	562, 567
Autoveyors, Ltd.	578	Gent and Co.	584
Beard and Fitch, Ltd.	529	Gil-Ray Radio Co.	580
Belling and Lee	589	Goswell Engineering Co.	563
Bland (S. E.)	584	Grafton Elec. Co.	578
Bretwood, Ltd.	578	Graham (A.) and Co.	564
Bowyer-Lowe Co.	530	Gran-Goldman Service	521
Brandes, Ltd.	518	Harding, Holland and Fry	582
Brighton Radio Stores	589	Harforth (Lewis) and Co.	582
British Battery Co.	582	Harlie Bros.	580
British Engineering Products	580	Helix, Ltd.	577
British L. M. Ericsson Mfg. Co.	546	Holdron (H.), Ltd.	583
B.T.-H. Co., Ltd.	534	Holmes (H. W.)	593
Brown (S. G.), Ltd.	597	H. T. C. Electrical Co.	549
Burndept, Ltd.	551, 584	Hunt (A. H.), Ltd.	589
Burne-Jones and Co.	558	Igranic Electric Co.	571
Chase Elec. Co.	587	International Corres. School	585
Climax Patents, Ltd.	593	Jackson Brothers	551
Collett (S. H.)	564	Kriseros Co.	580
C.A.V. Small Tools	559	Lighting Supplies Co.	571
Collinson's Precision Screw Co., Ltd.	529	Lissen, Ltd.	517
Cossor (A. C.), Ltd.	526	London Elec. Stores	591
Craik and Smith	585	London Elec. Wire Co.	493
Curtis (Peter), Ltd.	525, 537	McMichael (L.), Ltd.	549
Darex Radio Co.	564	Malone and Co.	579
Dixon (L.) and Co.	564	Marbaix (Gaston E.)	564
Dubilier Condenser Co., Ltd.	545, 553	Mars Aerial	529
Energo Products	585	Melitza Radio Co.	581
Falk, Stadelmann and Co., Ltd.	578	Metro-Viek Supplies	556
Fallon Condenser Co.	546	Microhm. Engineering Co.	549
Fletcher (F. and J.)	579	Molback (C.)	552
Fluxite	565	Mullard Radio Valve Co., Ltd.	566 & Cov. ii
Formo Co.	521	Naylor (J. H.), Ltd.	559
Gambrell Bros.	575	Neutron, Ltd.	557
		Oldham Accumulators	595
		Ormond Engineering Co.	522
		Peto-Scott Co.	538, 582
		Pickett Bros.	564
		Pitman (Sir Isaac) & Sons	594
		Portable Utilities Co., Ltd.	572, 581
		Power Equipment Co., Ltd.	575
		P. & M., Ltd.	581
		Radiax, Ltd.	561
		Radioco, Ltd.	599
		Radio Instruments, Ltd.	Cover iv
		Radio Panel Co.	582
		Radio Stocks	600
		R. A. P. Instrument Co.	531
		Rawplug Co.	551
		Raymond (K.)	540, 541
		Reynolds (Walter E.)	580
		Robinson (Lionel) and Co.	568
		Romac Motor Accessories	569
		Rose Bros. Elec. Co.	599
		Rosen (Ed.) and Co.	577
		Rothermel (R. A.)	555
		"S.A. Cutters"	589
		Shipton (E.) and Co., Ltd.	575
		Sterling Telephone and Elec. Co., Ltd.	494
		Telegraph Condenser Co., Ltd.	591
		Telephone Mfg. Co.	579
		Thomas Bros.	564
		"U.S." Radio Co.	565
		Vandervell (C. A.) and Co.	521
		Verstraeten (M.)	582
		Watmel Wireless Co.	577
		Watson Jones & Co.	584
		Wholesale Wireless Co.	583
		Wilkins and Wright, Ltd.	555
		World's Wireless Stores	579
		Zealander (H. D.)	580

The Best

**EVERYTHING
A GOOD
CONDENSER
SHOULD BE.**



"OCTOPUS"

By Test

	s.	d.
.01	2	4
.05	2	4
.25	3	0
.5	3	4
1 MF.	3	10
2 MF.	4	8

All capacities same size face. i.e., 2in. by 1 1/4in.

**ACCURATE, NOISELESS, PERMANENT,
ABSOLUTELY RELIABLE, TESTED AT 350 VOLTS D.C.
BEWARE IMITATIONS, LOOK FOR THE TRADE MARK.
30 YEARS' EXPERIENCE OF CONDENSER BUILDING
are behind the
"OCTOPUS" GUARANTEED
Mansbridge Condensers
THERE IS NO BETTER CONDENSER.**

VARIABLE CONDENSERS

	Ordinary	Square Law.	With 3 Plate Vernier.
	s. d.	s. d.	s. d.
BEST BRITISH MAKE	.001	7 3	9 6
ACCURATE SPACING	.0005	5 4	8 6
PERFECT FINISH	.0003	5 1	7 6
BEST VALUE OBTAINABLE	.0002	4 5	6 6
	.00005	3 1	—

1/6 EXTRA

PERFECT VERNIER BASKET COIL HOLDER.—Absolutely new and ideal, no coil mounts, no "fiddling." Coils can couple dead close—simple to use, results surprising; use any basket coils. Try at our risk; sent on 48 hours approval, post free, 7/-; set of five coils Broadcasting Wavelengths, 2/-.

COIL HOLDERS.—Plug-in 2-Way, Ebonite, 3/-, 3/6.
" " " 3 " 4/6, 5/6.

TRANSFORMERS.—L.F. Royal 20/-, Powquip 14/6, Bucks 11/6. Special, Nickelled, Shrouded, 12/-

POTENTIOMETERS.—A neat and superior article, solid ebonite circular, 350 ohms. 2/9

VERNIER RHEOSTATS for fine tuning, much better than the carbon type, which get "packed" 3/-

SWITCHES, S.P.D.T. on porcelain 10d.
with lightning arrester 1/3

H.T. BATTERIES, 60 volt, finest Continental 6/-

WONDER AERIAL, 49 strands, phosphor bronze, 100-ft. 3/6

HEADPHONES.—Continental 8/6, genuine Dr. Nesper's 12/6, Telefunken 18/6, Brande's, Browne's, Sterling, and all makes stocked.

SETS OF PARTS FOR ANY AND EVERY CIRCUIT

WE SPECIALISE IN GIVING THE BEST KNOWN VALUE AND SERVICE
WRITE YOUR ACTUAL NEEDS. GIVE US YOUR IDEAS AND LET US QUOTE

EVERYTHING FOR WIRELESS AT ROCK-BOTTOM PRICES

WRITE FOR LISTS
wholesale and Retail

**RADIO "STOCKS" (B. HAINE, Proprietor),
RADIO HOUSE, NEWMAN STREET, OXFORD ST., LONDON, W.1**

PHONE: MUSEUM 3205

A SIMPLE RADIO CONSTRUCTOR'S COURSE WITHIN TWO COVERS

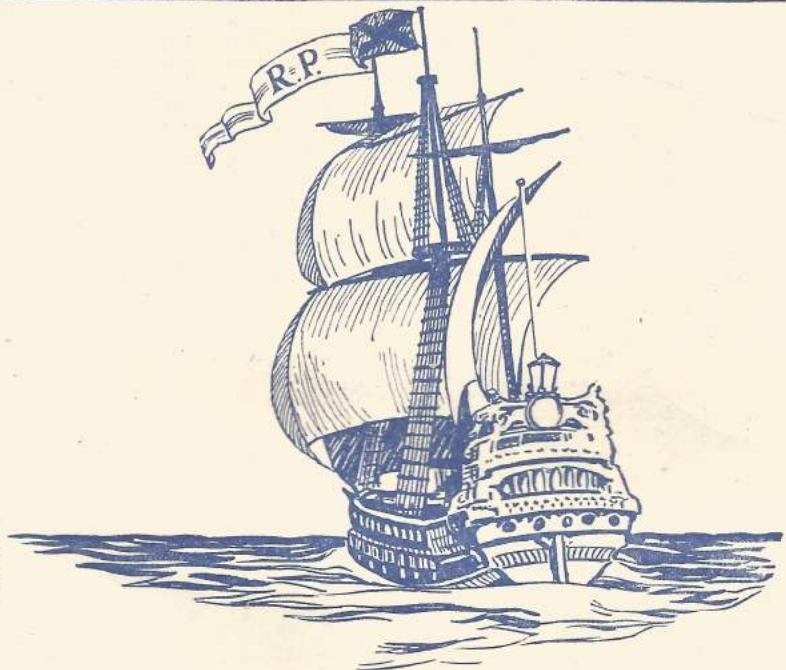

YOUR SHIP COMES HOME

with the publication of the latest Radio Press Book. To their already long list of wireless "Best sellers" the famous Radio Press have now added another book which it is anticipated will soon be found in the home of every wireless enthusiast.

"Six Simple Sets" by Stanley G. Rattee, M.I.R.E.,

like all the Radio Press books, fulfils a definite requirement of the radio public. This book constitutes what can be described as a carefully graded course of instruction in the making of wireless receivers from a crystal to a multi-valve set. It will especially appeal to that large and ever-growing body of wireless enthusiasts who desire to enter the field of experimental radio. Hitherto some of these enthusiasts have been puzzled as to the best way to commence, but "Six Simple Sets" will solve their problem.

Every set is well and clearly illustrated by exterior and interior photographs and circuit diagrams, which enable one to readily construct any of the six sets described. Every set has been built by the Author, and is guaranteed to give you efficient results if you carefully follow the concise and clear constructional details supplied.

Stanley G. Rattee, M.I.R.E., is a well-known and appreciated contributor to *Modern Wireless*, *Wireless Weekly*, and *The Wireless Constructor*, and his constructional articles are very much valued by the thousands of readers of these Radio Press publications.

Those who purchase this book will soon have a practical knowledge of set construction and will be well equipped for taking up experimental work if so desired.

Ask for the Radio Press Series No.W.21, Price 1/6. Obtainable from all Newsagents, Booksellers, your local Wireless Dealer, or direct from the Publishers. Post Free, 1/8.

When ordering be sure and quote Series No.W.21.

CONTENTS.

CHAPTER I.	Page
An easily constructed Crystal Receiver ...	11
CHAPTER II.	
A Single-Valve "Component" Set ...	18
CHAPTER III.	
A Universal Two-Valve Receiver ...	27
CHAPTER IV.	
A Two-Valve Power Amplifier... ..	35
CHAPTER V.	
A Simple Three-Valve Receiver	46
CHAPTER VI.	
A Four-Valve Broadcast Receiver	55



Get Your Copy To-day.

Radio Press, Ltd.,
BUSH HOUSE, STRAND, LONDON, W.C.2.



The Secret

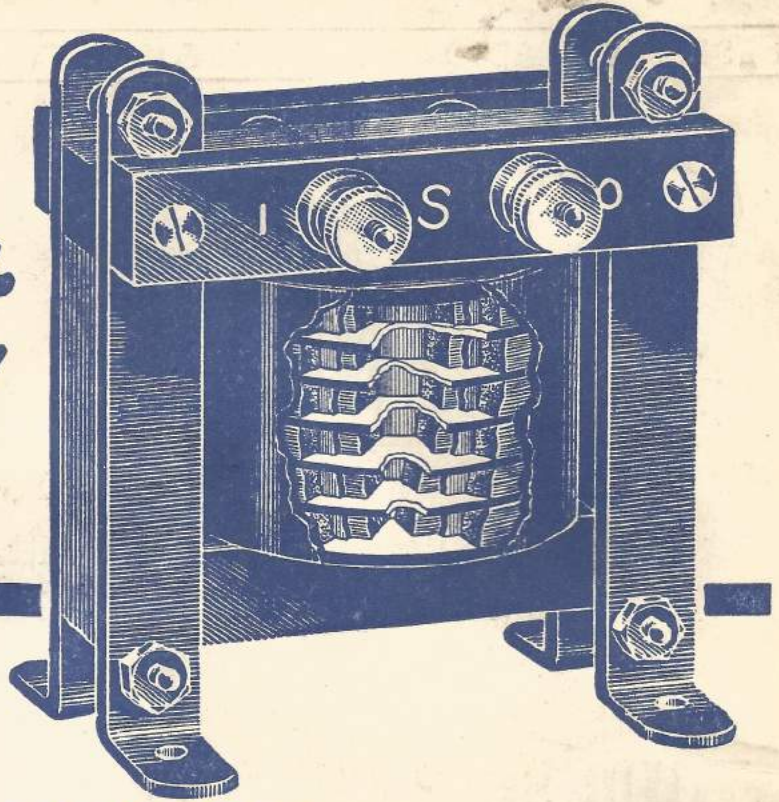

MORE THAN LOOKS

Anybody can make a transformer to LOOK like an R.I., but it takes 25 YEARS' EXPERIENCE to make a REAL R.I. The unique sectional method of winding the core of the R.I. transformer gives it the extremely low self capacity of ONLY 18 micro-microfarads.

THEREIN LIES THE SECRET OF DISTORTIONLESS AMPLIFICATION giving beautiful reproduction throughout the broadcasting range.

Again, the heavy walls of insulation between the primary and secondary windings as shown in the above illustration are important factors in the achievement of building the magnificent R.I. IT IS THE KNOWLEDGE OF HOW TO BUILD CORRECTLY THAT HAS GIVEN SATISFACTION TO OVER 350,000 R.I. USERS.

Make your transformer purchases R.I. and have R.I. RESULTS.

Price **25/-**

The new R.I. P.M. Detector, followed by one or two stages of amplification with R.I. transformers, is the ideal combination

The New R.I. P.M. Detector with metal brackets and necessary screws for mounting **6/=**

Ask for the new R.I. Catalogue.



12 HYDE ST OXFORD ST LONDON W.C.1

Contractors to the Admiralty and all Government Departments